

G522-0290-00

MPCFPE/AD
1/97
REV. 1

PowerPC™ Microprocessor Family: The Programming Environments



PowerPC



© Motorola Inc. 1997. All rights reserved.

Portions hereof © International Business Machines Corp. 1991-1997. All rights reserved.

This document contains information on a new product under development by Motorola and IBM. Motorola and IBM reserve the right to change or discontinue this product without notice. Information in this document is provided solely to enable system and software implementers to use PowerPC microprocessors. There are no express or implied copyright or patent licenses granted hereunder by Motorola or IBM to design, modify the design of, or fabricate circuits based on the information in this document.

The PowerPC microprocessor embodies the intellectual property of Motorola and of IBM. However, neither Motorola nor IBM assumes any responsibility or liability as to any aspects of the performance, operation, or other attributes of the microprocessor as marketed by the other party or by any third party. Neither Motorola nor IBM is to be considered an agent or representative of the other, and neither has assumed, created, or granted hereby any right or authority to the other, or to any third party, to assume or create any express or implied obligations on its behalf. Information such as errata sheets and data sheets, as well as sales terms and conditions such as prices, schedules, and support, for the product may vary as between parties selling the product. Accordingly, customers wishing to learn more information about the products as marketed by a given party should contact that party.

Both Motorola and IBM reserve the right to modify this document and/or any of the products as described herein without further notice. **NOTHING IN THIS DOCUMENT, NOR IN ANY OF THE ERRATA SHEETS, DATA SHEETS, AND OTHER SUPPORTING DOCUMENTATION, SHALL BE INTERPRETED AS THE CONVEYANCE BY MOTOROLA OR IBM OF AN EXPRESS WARRANTY OF ANY KIND OR IMPLIED WARRANTY, REPRESENTATION, OR GUARANTEE REGARDING THE MERCHANTABILITY OR FITNESS OF THE PRODUCTS FOR ANY PARTICULAR PURPOSE.** Neither Motorola nor IBM assumes any liability or obligation for damages of any kind arising out of the application or use of these materials. Any warranty or other obligations as to the products described herein shall be undertaken solely by the marketing party to the customer, under a separate sale agreement between the marketing party and the customer. In the absence of such an agreement, no liability is assumed by Motorola, IBM, or the marketing party for any damages, actual or otherwise.

"Typical" parameters can and do vary in different applications. All operating parameters, including "Typicals," must be validated for each customer application by customer's technical experts. Neither Motorola nor IBM convey any license under their respective intellectual property rights nor the rights of others. Neither Motorola nor IBM makes any claim, warranty, or representation, express or implied, that the products described in this document are designed, intended, or authorized for use as components in systems intended for surgical implant into the body, or other applications intended to support or sustain life, or for any other application in which the failure of the product could create a situation where personal injury or death may occur. Should customer purchase or use the products for any such unintended or unauthorized application, customer shall indemnify and hold Motorola and IBM and their respective officers, employees, subsidiaries, affiliates, and distributors harmless against all claims, costs, damages, and expenses, and reasonable attorney's fees arising out of, directly or indirectly, any claim of personal injury or death associated with such unintended or unauthorized use, even if such claim alleges that Motorola or IBM was negligent regarding the design or manufacture of the part.

Motorola and  are registered trademarks of Motorola, Inc. Motorola, Inc. is an Equal Opportunity/Affirmative Action Employer.

IBM, the IBM logo, IBM Microelectronics, RS/6000, and System/370 are trademarks of International Business Machines Corporation. The PowerPC name, the PowerPC logotype, PowerPC 601, PowerPC 602, PowerPC 603, PowerPC 603e, PowerPC 604, PowerPC 604e, and PowerPC 620 are trademarks of International Business Machines Corporation used by Motorola under license from International Business Machines Corporation. International Business Machines Corporation is an Equal Opportunity/Affirmative Action Employer.

Overview	1
PowerPC Register Set	2
Operand Conventions	3
Addressing Modes and Instruction Set Summary	4
Cache Model and Memory Coherency	5
Exceptions	6
Memory Management	7
Instruction Set	8
PowerPC Instruction Set Listings	A
POWER Architecture Cross Reference	B
Multiple-Precision Shifts	C
Floating-Point Models	D
Synchronization Programming Examples	E
Simplified Mnemonics	F
Glossary of Terms and Abbreviations	GLO
Index	IND

1	Overview
2	PowerPC Register Set
3	Operand Conventions
4	Addressing Modes and Instruction Set Summary
5	Cache Model and Memory Coherency
6	Exceptions
7	Memory Management
8	Instruction Set
A	PowerPC Instruction Set Listings
B	POWER Architecture Cross Reference
C	Multiple-Precision Shifts
D	Floating-Point Models
E	Synchronization Programming Examples
F	Simplified Mnemonics
GLO	Glossary of Terms and Abbreviations
IND	Index

CONTENTS

Paragraph Number	Title	Page Number
About This Book		
	Audience	xxix
	Organization.....	xxix
	Suggested Reading.....	xxx
	Conventions	xxxiii
	Acronyms and Abbreviations	xxxiv
	Terminology Conventions	xxxvii
Chapter 1		
Overview		
1.1	PowerPC Architecture Overview.....	1-2
1.1.1	The 64-Bit PowerPC Architecture and the 32-Bit Subset	1-4
1.1.2	The Levels of the PowerPC Architecture	1-5
1.1.3	Latitude Within the Levels of the PowerPC Architecture	1-7
1.1.4	Features Not Defined by the PowerPC Architecture	1-8
1.1.5	Summary of Architectural Changes in this Revision.....	1-9
1.2	The PowerPC Architectural Models	1-10
1.2.1	PowerPC Registers and Programming Model	1-10
1.2.2	Operand Conventions	1-11
1.2.2.1	Byte Ordering	1-11
1.2.2.2	Data Organization in Memory and Data Transfers.....	1-12
1.2.2.3	Floating-Point Conventions	1-12
1.2.3	PowerPC Instruction Set and Addressing Modes	1-12
1.2.3.1	PowerPC Instruction Set.....	1-13
1.2.3.2	Calculating Effective Addresses.....	1-15
1.2.4	PowerPC Cache Model.....	1-15
1.2.5	PowerPC Exception Model.....	1-16
1.2.6	PowerPC Memory Management Model	1-16
1.3	Changes in This Revision of The Programming Environments Manual	1-18
1.3.1	General Changes to the PowerPC Architecture	1-19
1.3.2	Changes Related to the Optional 64-Bit Bridge	1-19

CONTENTS

Paragraph Number	Title	Page Number
Chapter 2		
PowerPC Register Set		
2.1	PowerPC UISA Register Set.....	2-1
2.1.1	General-Purpose Registers (GPRs).....	2-3
2.1.2	Floating-Point Registers (FPRs).....	2-4
2.1.3	Condition Register (CR).....	2-5
2.1.3.1	Condition Register CR0 Field Definition.....	2-6
2.1.3.2	Condition Register CR1 Field Definition.....	2-6
2.1.3.3	Condition Register CR n Field—Compare Instruction.....	2-7
2.1.4	Floating-Point Status and Control Register (FPSCR).....	2-7
2.1.5	XER Register (XER).....	2-11
2.1.6	Link Register (LR).....	2-11
2.1.7	Count Register (CTR).....	2-12
2.2	PowerPC VEA Register Set—Time Base.....	2-13
2.2.1	Reading the Time Base.....	2-16
2.2.1.1	Reading the Time Base on 64-Bit Implementations.....	2-16
2.2.1.2	Reading the Time Base on 32-Bit Implementations.....	2-16
2.2.2	Computing Time of Day from the Time Base.....	2-17
2.3	PowerPC OEA Register Set.....	2-17
2.3.1	Machine State Register (MSR).....	2-20
2.3.2	Processor Version Register (PVR).....	2-24
2.3.3	BAT Registers.....	2-25
2.3.4	SDR1.....	2-28
2.3.5	Address Space Register (ASR).....	2-30
2.3.6	Segment Registers.....	2-31
2.3.7	Data Address Register (DAR).....	2-33
2.3.8	SPRG0–SPRG3.....	2-33
2.3.9	DSISR.....	2-34
2.3.10	Machine Status Save/Restore Register 0 (SRR0).....	2-34
2.3.11	Machine Status Save/Restore Register 1 (SRR1).....	2-35
2.3.12	Floating-Point Exception Cause Register (FPECR).....	2-36
2.3.13	Time Base Facility (TB)—OEA.....	2-36
2.3.13.1	Writing to the Time Base.....	2-36
2.3.14	Decrementer Register (DEC).....	2-37
2.3.14.1	Decrementer Operation.....	2-37
2.3.14.2	Writing and Reading the DEC.....	2-38
2.3.15	Data Address Breakpoint Register (DABR).....	2-38
2.3.16	External Access Register (EAR).....	2-39
2.3.17	Processor Identification Register (PIR).....	2-40
2.3.18	Synchronization Requirements for Special Registers and for Lookaside Buffers.....	2-40

CONTENTS

Paragraph Number	Title	Page Number
Chapter 3		
Operand Conventions		
3.1	Data Organization in Memory and Data Transfers.....	3-1
3.1.1	Aligned and Misaligned Accesses	3-1
3.1.2	Byte Ordering	3-2
3.1.2.1	Big-Endian Byte Ordering	3-2
3.1.2.2	Little-Endian Byte Ordering	3-3
3.1.3	Structure Mapping Examples.....	3-3
3.1.3.1	Big-Endian Mapping	3-4
3.1.3.2	Little-Endian Mapping.....	3-5
3.1.4	PowerPC Byte Ordering	3-6
3.1.4.1	Aligned Scalars in Little-Endian Mode	3-6
3.1.4.2	Misaligned Scalars in Little-Endian Mode	3-9
3.1.4.3	Nonscalars.....	3-10
3.1.4.4	PowerPC Instruction Addressing in Little-Endian Mode.....	3-10
3.1.4.5	PowerPC Input/Output Data Transfer Addressing in Little-Endian Mode	3-11
3.2	Effect of Operand Placement on Performance—VEA	3-12
3.2.1	Summary of Performance Effects.....	3-12
3.2.2	Instruction Restart.....	3-14
3.3	Floating-Point Execution Models—UIISA	3-15
3.3.1	Floating-Point Data Format	3-16
3.3.1.1	Value Representation.....	3-18
3.3.1.2	Binary Floating-Point Numbers.....	3-19
3.3.1.3	Normalized Numbers (\pm NORM)	3-19
3.3.1.4	Zero Values (\pm 0).....	3-20
3.3.1.5	Denormalized Numbers (\pm DENORM).....	3-20
3.3.1.6	Infinities ($\pm\infty$)	3-21
3.3.1.7	Not a Numbers (NaNs)	3-21
3.3.2	Sign of Result.....	3-22
3.3.3	Normalization and Denormalization.....	3-23
3.3.4	Data Handling and Precision	3-24
3.3.5	Rounding.....	3-25
3.3.6	Floating-Point Program Exceptions.....	3-28
3.3.6.1	Invalid Operation and Zero Divide Exception Conditions	3-35
3.3.6.1.1	Invalid Operation Exception Condition.....	3-37
3.3.6.1.2	Zero Divide Exception Condition.....	3-38
3.3.6.2	Overflow, Underflow, and Inexact Exception Conditions	3-39
3.3.6.2.1	Overflow Exception Condition.....	3-41
3.3.6.2.2	Underflow Exception Condition.....	3-42
3.3.6.2.3	Inexact Exception Condition	3-43

CONTENTS

Paragraph Number	Title	Page Number
Chapter 4		
Addressing Modes and Instruction Set Summary		
4.1	Conventions	4-2
4.1.1	Sequential Execution Model	4-3
4.1.2	Computation Modes	4-3
4.1.2.1	64-Bit Implementations	4-3
4.1.2.2	32-Bit Implementations	4-4
4.1.3	Classes of Instructions	4-4
4.1.3.1	Definition of Boundedly Undefined	4-4
4.1.3.2	Defined Instruction Class	4-4
4.1.3.2.1	Preferred Instruction Forms	4-5
4.1.3.2.2	Invalid Instruction Forms	4-5
4.1.3.2.3	Optional Instructions	4-5
4.1.3.3	Illegal Instruction Class	4-6
4.1.3.4	Reserved Instructions	4-7
4.1.4	Memory Addressing	4-7
4.1.4.1	Memory Operands	4-7
4.1.4.2	Effective Address Calculation	4-8
4.1.5	Synchronizing Instructions	4-9
4.1.5.1	Context Synchronizing Instructions	4-9
4.1.5.2	Execution Synchronizing Instructions	4-10
4.1.6	Exception Summary	4-10
4.2	PowerPC UISA Instructions	4-11
4.2.1	Integer Instructions	4-11
4.2.1.1	Integer Arithmetic Instructions	4-12
4.2.1.2	Integer Compare Instructions	4-17
4.2.1.3	Integer Logical Instructions	4-18
4.2.1.4	Integer Rotate and Shift Instructions	4-21
4.2.1.4.1	Integer Rotate Instructions	4-21
4.2.1.4.2	Integer Shift Instructions	4-23
4.2.2	Floating-Point Instructions	4-25
4.2.2.1	Floating-Point Arithmetic Instructions	4-26
4.2.2.2	Floating-Point Multiply-Add Instructions	4-28
4.2.2.3	Floating-Point Rounding and Conversion Instructions	4-29
4.2.2.4	Floating-Point Compare Instructions	4-31
4.2.2.5	Floating-Point Status and Control Register Instructions	4-31
4.2.2.6	Floating-Point Move Instructions	4-33

CONTENTS

Paragraph Number	Title	Page Number
4.2.3	Load and Store Instructions	4-33
4.2.3.1	Integer Load and Store Address Generation.....	4-34
4.2.3.1.1	Register Indirect with Immediate Index Addressing for Integer Loads and Stores	4-34
4.2.3.1.2	Register Indirect with Index Addressing for Integer Loads and Stores.	4-35
4.2.3.1.3	Register Indirect Addressing for Integer Loads and Stores.....	4-35
4.2.3.2	Integer Load Instructions	4-36
4.2.3.3	Integer Store Instructions.....	4-38
4.2.3.4	Integer Load and Store with Byte-Reverse Instructions.....	4-40
4.2.3.5	Integer Load and Store Multiple Instructions	4-41
4.2.3.6	Integer Load and Store String Instructions	4-42
4.2.3.7	Floating-Point Load and Store Address Generation	4-42
4.2.3.7.1	Register Indirect with Immediate Index Addressing for Floating-Point Loads and Stores.....	4-43
4.2.3.7.2	Register Indirect with Index Addressing for Floating-Point Loads and Stores	4-43
4.2.3.8	Floating-Point Load Instructions	4-44
4.2.3.9	Floating-Point Store Instructions	4-45
4.2.4	Branch and Flow Control Instructions.....	4-47
4.2.4.1	Branch Instruction Address Calculation	4-47
4.2.4.1.1	Branch Relative Addressing Mode.....	4-47
4.2.4.1.2	Branch Conditional to Relative Addressing Mode	4-48
4.2.4.1.3	Branch to Absolute Addressing Mode.....	4-49
4.2.4.1.4	Branch Conditional to Absolute Addressing Mode.....	4-50
4.2.4.1.5	Branch Conditional to Link Register Addressing Mode	4-50
4.2.4.1.6	Branch Conditional to Count Register Addressing Mode	4-51
4.2.4.2	Conditional Branch Control.....	4-52
4.2.4.3	Branch Instructions	4-55
4.2.4.4	Simplified Mnemonics for Branch Processor Instructions	4-56
4.2.4.5	Condition Register Logical Instructions	4-56
4.2.4.6	Trap Instructions	4-57
4.2.4.7	System Linkage Instruction—UISA.....	4-57
4.2.5	Processor Control Instructions—UISA	4-58
4.2.5.1	Move to/from Condition Register Instructions	4-58
4.2.5.2	Move to/from Special-Purpose Register Instructions (UISA).....	4-58
4.2.6	Memory Synchronization Instructions—UISA	4-59
4.2.7	Recommended Simplified Mnemonics.....	4-61
4.3	PowerPC VEA Instructions	4-62
4.3.1	Processor Control Instructions—VEA.....	4-62
4.3.2	Memory Synchronization Instructions—VEA	4-63
4.3.3	Memory Control Instructions—VEA	4-64
4.3.3.1	User-Level Cache Instructions—VEA	4-64
4.3.4	External Control Instructions.....	4-68

CONTENTS

Paragraph Number	Title	Page Number
4.4	PowerPC OEA Instructions	4-69
4.4.1	System Linkage Instructions—OEA	4-69
4.4.2	Processor Control Instructions—OEA.....	4-70
4.4.2.1	Move to/from Machine State Register Instructions.....	4-71
4.4.2.2	Move to/from Special-Purpose Register Instructions (OEA).....	4-71
4.4.3	Memory Control Instructions—OEA	4-72
4.4.3.1	Supervisor-Level Cache Management Instruction	4-72
4.4.3.2	Segment Register Manipulation Instructions.....	4-73
4.4.3.3	Translation and Segment Lookaside Buffer Management Instructions	4-75

Chapter 5 Cache Model and Memory Coherency

5.1	The Virtual Environment	5-1
5.1.1	Memory Access Ordering.....	5-2
5.1.1.1	Enforce In-Order Execution of I/O Instruction	5-2
5.1.1.2	Synchronize Instruction	5-3
5.1.2	Atomicity	5-4
5.1.3	Cache Model.....	5-5
5.1.4	Memory Coherency	5-5
5.1.4.1	Memory/Cache Access Modes	5-6
5.1.4.1.1	Pages Designated as Write-Through	5-6
5.1.4.1.2	Pages Designated as Caching-Inhibited.....	5-6
5.1.4.1.3	Pages Designated as Memory Coherency Required.....	5-7
5.1.4.1.4	Pages Designated as Memory Coherency Not Required.....	5-7
5.1.4.1.5	Pages Designated as Guarded.....	5-7
5.1.4.2	Coherency Precautions	5-7
5.1.5	VEA Cache Management Instructions	5-8
5.1.5.1	Data Cache Instructions.....	5-8
5.1.5.1.1	Data Cache Block Touch (dcbt) and Data Cache Block Touch for Store (dcbst) Instructions.....	5-8
5.1.5.1.2	Data Cache Block Set to Zero (dcbz) Instruction	5-9
5.1.5.1.3	Data Cache Block Store (dcbst) Instruction.....	5-9
5.1.5.1.4	Data Cache Block Flush (dcbf) Instruction.....	5-10
5.1.5.2	Instruction Cache Instructions	5-10
5.1.5.2.1	Instruction Cache Block Invalidate Instruction (icbi)	5-11
5.1.5.2.2	Instruction Synchronize Instruction (isync)	5-11
5.2	The Operating Environment	5-12
5.2.1	Memory/Cache Access Attributes	5-12
5.2.1.1	Write-Through Attribute (W)	5-13
5.2.1.2	Caching-Inhibited Attribute (I).....	5-14
5.2.1.3	Memory Coherency Attribute (M).....	5-15
5.2.1.4	W, I, and M Bit Combinations.....	5-15

CONTENTS

Paragraph Number	Title	Page Number
5.2.1.5	The Guarded Attribute (G)	5-16
5.2.1.5.1	Performing Operations Out of Order	5-16
5.2.1.5.2	Guarded Memory	5-17
5.2.1.5.3	Out-of-Order Accesses to Guarded Memory	5-18
5.2.2	I/O Interface Considerations	5-19
5.2.3	OEA Cache Management Instruction— Data Cache Block Invalidate (dcbi)	5-19

Chapter 6 Exceptions

6.1	Exception Classes	6-3
6.1.1	Precise Exceptions	6-6
6.1.2	Synchronization	6-6
6.1.2.1	Context Synchronization	6-6
6.1.2.2	Execution Synchronization	6-7
6.1.2.3	Synchronous/Precise Exceptions	6-7
6.1.2.4	Asynchronous Exceptions	6-8
6.1.2.4.1	System Reset and Machine Check Exceptions	6-8
6.1.2.4.2	External Interrupt and Decrementer Exceptions	6-8
6.1.3	Imprecise Exceptions	6-9
6.1.3.1	Imprecise Exception Status Description	6-9
6.1.3.2	Recoverability of Imprecise Floating-Point Exceptions	6-10
6.1.4	Partially Executed Instructions	6-11
6.1.5	Exception Priorities	6-12
6.2	Exception Processing	6-14
6.2.1	Enabling and Disabling Exceptions	6-18
6.2.2	Steps for Exception Processing	6-19
6.2.3	Returning from an Exception Handler	6-20
6.3	Process Switching	6-21
6.4	Exception Definitions	6-22
6.4.1	System Reset Exception (0x00100)	6-23
6.4.2	Machine Check Exception (0x00200)	6-24
6.4.3	DSI Exception (0x00300)	6-25
6.4.4	ISI Exception (0x00400)	6-28
6.4.5	External Interrupt (0x00500)	6-29
6.4.6	Alignment Exception (0x00600)	6-30
6.4.6.1	Integer Alignment Exceptions	6-33
6.4.6.1.1	Page Address Translation Access Considerations	6-33
6.4.6.1.2	Direct-Store Interface Access Considerations	6-33
6.4.6.2	Little-Endian Mode Alignment Exceptions	6-33
6.4.6.3	Interpretation of the DSISR as Set by an Alignment Exception	6-34

CONTENTS

Paragraph Number	Title	Page Number
6.4.7	Program Exception (0x00700).....	6-36
6.4.8	Floating-Point Unavailable Exception (0x00800).....	6-38
6.4.9	Decrementer Exception (0x00900).....	6-38
6.4.10	System Call Exception (0x00C00).....	6-39
6.4.11	Trace Exception (0x00D00).....	6-40
6.4.12	Floating-Point Assist Exception (0x00E00).....	6-42

Chapter 7 Memory Management

7.1	MMU Features.....	7-2
7.2	MMU Overview.....	7-4
7.2.1	Memory Addressing.....	7-6
7.2.1.1	Effective Addresses in 32-Bit Mode.....	7-6
7.2.1.2	Predefined Physical Memory Locations.....	7-6
7.2.2	MMU Organization.....	7-7
7.2.3	Address Translation Mechanisms.....	7-12
7.2.4	Memory Protection Facilities.....	7-15
7.2.5	Page History Information.....	7-17
7.2.6	General Flow of MMU Address Translation.....	7-17
7.2.6.1	Real Addressing Mode and Block Address Translation Selection.....	7-17
7.2.6.2	Page and Direct-Store Address Translation Selection.....	7-18
7.2.6.2.1	Selection of Page Address Translation.....	7-21
7.2.6.2.2	Selection of Direct-Store Address Translation.....	7-22
7.2.7	MMU Exceptions Summary.....	7-22
7.2.8	MMU Instructions and Register Summary.....	7-24
7.2.9	TLB Entry Invalidation.....	7-27
7.3	Real Addressing Mode.....	7-27
7.4	Block Address Translation.....	7-28
7.4.1	BAT Array Organization.....	7-29
7.4.2	Recognition of Addresses in BAT Arrays.....	7-31
7.4.3	BAT Register Implementation of BAT Array.....	7-33
7.4.4	Block Memory Protection.....	7-37
7.4.5	Block Physical Address Generation.....	7-40
7.4.6	Block Address Translation Summary.....	7-42
7.5	Memory Segment Model.....	7-42
7.5.1	Recognition of Addresses in Segments.....	7-43
7.5.1.1	Selection of Memory Segments.....	7-43
7.5.1.2	Selection of Direct-Store Segments.....	7-44
7.5.2	Page Address Translation Overview.....	7-44
7.5.2.1	Segment Descriptor Definitions.....	7-47
7.5.2.1.1	STE Format—64-Bit Implementations.....	7-47
7.5.2.1.2	Segment Descriptor Format—32-Bit Implementations.....	7-49

CONTENTS

Paragraph Number	Title	Page Number
7.5.2.2	Page Table Entry (PTE) Definitions.....	7-51
7.5.2.2.1	PTE Format for 64-Bit Implementations.....	7-51
7.5.2.2.2	PTE Format for 32-Bit Implementations.....	7-52
7.5.3	Page History Recording.....	7-53
7.5.3.1	Referenced Bit.....	7-54
7.5.3.2	Changed Bit.....	7-55
7.5.3.3	Scenarios for Referenced and Changed Bit Recording.....	7-55
7.5.3.4	Synchronization of Memory Accesses and Referenced and Changed Bit Updates.....	7-57
7.5.4	Page Memory Protection.....	7-57
7.5.5	Page Address Translation Summary.....	7-61
7.6	Hashed Page Tables.....	7-63
7.6.1	Page Table Definition.....	7-64
7.6.1.1	SDR1 Register Definitions.....	7-65
7.6.1.1.1	SDR1 Register Definition for 64-Bit Implementations.....	7-65
7.6.1.1.2	SDR1 Register Definition for 32-Bit Implementations.....	7-66
7.6.1.2	Page Table Size.....	7-67
7.6.1.2.1	Page Table Sizes for 64-Bit Implementations.....	7-68
7.6.1.2.2	Page Table Sizes for 32-Bit Implementations.....	7-69
7.6.1.3	Page Table Hashing Functions.....	7-70
7.6.1.3.1	Page Table Hashing Functions—64-Bit Implementations.....	7-70
7.6.1.3.2	Page Table Hashing Functions—32-Bit Implementations.....	7-71
7.6.1.4	Page Table Addresses.....	7-72
7.6.1.4.1	Page Table Address Generation for 64-Bit Implementations.....	7-73
7.6.1.4.2	Page Table Address Generation for 32-Bit Implementations.....	7-75
7.6.1.5	Page Table Structure Summary.....	7-77
7.6.1.6	Page Table Structure Examples.....	7-78
7.6.1.6.1	Example Page Table for 64-Bit Implementation.....	7-78
7.6.1.6.2	Example Page Table for 32-Bit Implementation.....	7-79
7.6.1.7	PTEG Address Mapping Examples.....	7-81
7.6.1.7.1	PTEG Address Mapping Example—64-Bit Implementation.....	7-81
7.6.1.7.2	PTEG Address Mapping Example—32-Bit Implementation.....	7-84
7.6.2	Page Table Search Operation.....	7-87
7.6.2.1	Page Table Search Operation for 64-Bit Implementations.....	7-87
7.6.2.2	Page Table Search Operation for 32-Bit Implementations.....	7-88
7.6.2.3	Flow for Page Table Search Operation.....	7-89
7.6.3	Page Table Updates.....	7-91
7.6.3.1	Adding a Page Table Entry.....	7-92
7.6.3.2	Modifying a Page Table Entry.....	7-93
7.6.3.2.1	General Case.....	7-93
7.6.3.2.2	Clearing the Referenced (R) Bit.....	7-93
7.6.3.2.3	Modifying the Virtual Address.....	7-94
7.6.3.3	Deleting a Page Table Entry.....	7-94

CONTENTS

Paragraph Number	Title	Page Number
7.6.4	ASR and Segment Register Updates	7-95
7.7	Hashed Segment Tables—64-Bit Implementations.....	7-95
7.7.1	Segment Table Definition.....	7-95
7.7.1.1	Address Space Register (ASR).....	7-97
7.7.1.2	Segment Table Hashing Functions	7-98
7.7.1.3	Segment Table Address Generation	7-100
7.7.1.4	Segment Table in 32-Bit Mode.....	7-103
7.7.1.5	Segment Table Structure (with Examples).....	7-103
7.7.2	Segment Table Search Operation	7-106
7.7.3	Segment Table Updates	7-107
7.7.3.1	Adding a Segment Table Entry.....	7-108
7.7.3.2	Modifying a Segment Table Entry	7-109
7.7.3.3	Deleting a Segment Table Entry.....	7-109
7.8	Direct-Store Segment Address Translation	7-110
7.8.1	Segment Descriptors for Direct-Store Segments	7-110
7.8.2	Direct-Store Segment Accesses	7-112
7.8.3	Direct-Store Segment Protection	7-112
7.8.4	Instructions Not Supported in Direct-Store Segments.....	7-112
7.8.5	Instructions with No Effect in Direct-Store Segments	7-113
7.8.6	Direct-Store Segment Translation Summary Flow.....	7-113
7.9	Migration of Operating Systems from 32-Bit Implementations to 64-Bit Implementations	7-115
7.9.1	ISF Bit of the Machine State Register	7-116
7.9.2	rfi and mtmsr Instructions in a 64-Bit Implementation.....	7-116
7.9.3	Segment Register Manipulation Instructions in the 64-Bit Bridge.....	7-117
7.9.4	64-Bit Bridge Implementation of Segment Register Instructions Previously Defined for 32-Bit Implementations Only.....	7-118
7.9.4.1	Move from Segment Register— mfsr	7-118
7.9.4.2	Move from Segment Register Indirect— mfsrin	7-119
7.9.4.3	Move to Segment Register— mtsr	7-120
7.9.4.4	Move to Segment Register Indirect— mtsrin	7-121
7.9.5	Segment Register Instructions Defined Exclusively for the 64-Bit Bridge.	7-122
7.9.5.1	Move to Segment Register Double Word— mtsr d	7-123
7.9.5.2	Move to Segment Register Double Word Indirect— mtsr din.....	7-123

CONTENTS

Paragraph Number	Title	Page Number
Chapter 8		
Instruction Set		
8.1	Instruction Formats	8-1
8.1.1	Split-Field Notation	8-2
8.1.2	Instruction Fields	8-2
8.1.3	Notation and Conventions	8-4
8.1.4	Computation Modes.....	8-8
8.2	PowerPC Instruction Set.....	8-9
Appendix A		
PowerPC Instruction Set Listings		
A.1	Instructions Sorted by Mnemonic.....	A-1
A.2	Instructions Sorted by Opcode.....	A-9
A.3	Instructions Grouped by Functional Categories	A-17
A.4	Instructions Sorted by Form.....	A-29
A.5	Instruction Set Legend	A-41
Appendix B		
POWER Architecture Cross Reference		
B.1	New Instructions, Formerly Supervisor-Level Instructions.....	B-1
B.2	New Supervisor-Level Instructions	B-1
B.3	Reserved Bits in Instructions	B-2
B.4	Reserved Bits in Registers	B-2
B.5	Alignment Check	B-2
B.6	Condition Register	B-2
B.7	Inappropriate Use of LK and Rc bits	B-3
B.8	BO Field.....	B-3
B.9	Branch Conditional to Count Register.....	B-4
B.10	System Call/Supervisor Call	B-4
B.11	XER Register	B-4
B.12	Update Forms of Memory Access	B-4
B.13	Multiple Register Loads.....	B-5
B.14	Alignment for Load/Store Multiple	B-5
B.15	Load and Store String Instructions	B-5
B.16	Synchronization	B-5
B.17	Move to/from SPR	B-6
B.18	Effects of Exceptions on FPSCR Bits FR and FI	B-6
B.19	Floating-Point Store Single Instructions.....	B-7
B.20	Move from FPSCR	B-7

CONTENTS

Paragraph Number	Title	Page Number
B.21	Clearing Bytes in the Data Cache	B-7
B.22	Segment Register Instructions	B-7
B.23	TLB Entry Invalidation.....	B-8
B.24	Floating-Point Exceptions.....	B-8
B.25	Timing Facilities	B-8
B.25.1	Real-Time Clock.....	B-8
B.25.2	Decrementer.....	B-9
B.26	Deleted Instructions	B-9
B.27	POWER Instructions Supported by the PowerPC Architecture	B-11

Appendix C Multiple-Precision Shifts

C.1	Multiple-Precision Shifts in 64-Bit Mode.....	C-2
C.2	Multiple-Precision Shifts in 32-Bit Mode.....	C-3

Appendix D Floating-Point Models

D.1	Execution Model for IEEE Operations	D-1
D.2	Execution Model for Multiply-Add Type Instructions.....	D-4
D.3	Floating-Point Conversions	D-5
D.3.1	Conversion from Floating-Point Number to Floating-Point Integer	D-5
D.3.2	Conversion from Floating-Point Number to Signed Fixed-Point Integer Double Word	D-6
D.3.3	Conversion from Floating-Point Number to Unsigned Fixed-Point Integer Double Word	D-6
D.3.4	Conversion from Floating-Point Number to Signed Fixed-Point Integer Word.....	D-6
D.3.5	Conversion from Floating-Point Number to Unsigned Fixed-Point Integer Word.....	D-7
D.3.6	Conversion from Signed Fixed-Point Integer Double Word to Floating-Point Number	D-7
D.3.7	Conversion from Unsigned Fixed-Point Integer Double Word to Floating-Point Number	D-8
D.3.8	Conversion from Signed Fixed-Point Integer Word to Floating-Point Number	D-8
D.3.9	Conversion from Unsigned Fixed-Point Integer Word to Floating-Point Number	D-9
D.4	Floating-Point Models	D-9
D.4.1	Floating-Point Round to Single-Precision Model.....	D-9
D.4.2	Floating-Point Convert to Integer Model.....	D-13
D.4.3	Floating-Point Convert from Integer Model.....	D-15

CONTENTS

Paragraph Number	Title	Page Number
D.5	Floating-Point Selection.....	D-16
D.5.1	Comparison to Zero	D-17
D.5.2	Minimum and Maximum	D-17
D.5.3	Simple If-Then-Else Constructions	D-17
D.5.4	Notes	D-17
D.6	Floating-Point Load Instructions	D-18
D.7	Floating-Point Store Instructions	D-19

Appendix E Synchronization Programming Examples

E.1	General Information.....	E-1
E.2	Synchronization Primitives.....	E-2
E.2.1	Fetch and No-Op.....	E-2
E.2.2	Fetch and Store	E-3
E.2.3	Fetch and Add.....	E-3
E.2.4	Fetch and AND	E-3
E.2.5	Test and Set.....	E-3
E.3	Compare and Swap	E-4
E.4	Lock Acquisition and Release	E-5
E.5	List Insertion	E-6

Appendix F Simplified Mnemonics

F.1	Symbols	F-1
F.2	Simplified Mnemonics for Subtract Instructions.....	F-2
F.2.1	Subtract Immediate	F-2
F.2.2	Subtract	F-2
F.3	Simplified Mnemonics for Compare Instructions.....	F-3
F.3.1	Double-Word Comparisons	F-3
F.3.2	Word Comparisons	F-3
F.4	Simplified Mnemonics for Rotate and Shift Instructions	F-4
F.4.1	Operations on Double Words	F-5
F.4.2	Operations on Words	F-5
F.5	Simplified Mnemonics for Branch Instructions.....	F-7
F.5.1	BO and BI Fields	F-7
F.5.2	Basic Branch Mnemonics	F-7
F.5.3	Branch Mnemonics Incorporating Conditions.....	F-13
F.5.4	Branch Prediction	F-18
F.6	Simplified Mnemonics for Condition Register Logical Instructions.....	F-19
F.7	Simplified Mnemonics for Trap Instructions.....	F-20

CONTENTS

Paragraph Number	Title	Page Number
F.8	Simplified Mnemonics for Special-Purpose Registers	F-22
F.9	Recommended Simplified Mnemonics	F-23
F.9.1	No-Op (nop)	F-23
F.9.2	Load Immediate (li)	F-23
F.9.3	Load Address (la)	F-24
F.9.4	Move Register (mr)	F-24
F.9.5	Complement Register (not)	F-24
F.9.6	Move to Condition Register (mtcr)	F-24

Glossary of Terms and Abbreviations

Index

ILLUSTRATIONS

Figure Number	Title	Page Number
1-1	Programming Model—PowerPC Registers	1-10
1-2	Big-Endian Byte and Bit Ordering.....	1-12
2-1	UISA Programming Model—User-Level Registers	2-2
2-2	General-Purpose Registers (GPRs)	2-4
2-3	Floating-Point Registers (FPRs).....	2-5
2-4	Condition Register (CR).....	2-5
2-5	Floating-Point Status and Control Register (FPSCR)	2-8
2-6	XER Register.....	2-11
2-7	Link Register (LR)	2-12
2-8	Count Register (CTR)	2-12
2-9	VEA Programming Model—User-Level Registers Plus Time Base	2-14
2-10	Time Base (TB).....	2-15
2-11	OEA Programming Model—All Registers	2-18
2-12	Machine State Register (MSR)—64-Bit Implementations	2-21
2-13	Machine State Register (MSR)—32-Bit Implementations	2-21
2-14	Processor Version Register (PVR).....	2-24
2-15	Upper BAT Register—64-Bit Implementations	2-25
2-16	Lower BAT Register—64-Bit Implementations	2-25
2-17	Upper BAT Register—32-Bit Implementations	2-25
2-18	Lower BAT Register—32-Bit Implementations	2-26
2-19	SDR1—64-Bit Implementations	2-28
2-20	SDR1—32-Bit Implementations	2-29
2-21	Address Space Register (ASR)—64-Bit Implementations Only	2-30
2-22	Address Space Register (ASR)—64-Bit Bridge	2-31
2-23	Segment Register Format (T = 0).....	2-32
2-24	Segment Register Format (T = 1).....	2-32
2-25	Data Address Register (DAR).....	2-33
2-26	SPRG0—SPRG3	2-34
2-27	DSISR.....	2-34
2-28	Machine Status Save/Restore Register 0 (SRR0)	2-35
2-29	Machine Status Save/Restore Register 1 (SRR1)	2-35
2-30	Decrementer Register (DEC)	2-37
2-31	Data Address Breakpoint Register (DABR)	2-38
2-32	External Access Register (EAR)	2-39
3-1	C Program Example—Data Structure S.....	3-3
3-2	Big-Endian Mapping of Structure S	3-4

ILLUSTRATIONS

Figure Number	Title	Page Number
3-3	Little-Endian Mapping of Structure <i>S</i>	3-5
3-4	Little-Endian Mapping of Structure <i>S</i> —Alternate View	3-6
3-5	Munged Little-Endian Structure <i>S</i> as Seen by the Memory Subsystem	3-7
3-6	Munged Little-Endian Structure <i>S</i> as Seen by Processor	3-8
3-7	True Little-Endian Mapping, Word Stored at Address 05	3-9
3-8	Word Stored at Little-Endian Address 05 as Seen by the Memory Subsystem ...	3-10
3-9	Floating-Point Single-Precision Format	3-16
3-10	Floating-Point Double-Precision Format	3-16
3-11	Approximation to Real Numbers	3-18
3-12	Format for Normalized Numbers	3-19
3-13	Format for Zero Numbers	3-20
3-14	Format for Denormalized Numbers	3-20
3-15	Format for Positive and Negative Infinities	3-21
3-16	Format for NaNs.....	3-21
3-17	Representation of Generated QNaN.....	3-22
3-18	Single-Precision Representation in an FPR	3-25
3-19	Relation of Z1 and Z2	3-26
3-20	Selection of Z1 and Z2 for the Four Rounding Modes	3-27
3-21	Rounding Flags in FPSCR	3-28
3-22	Floating-Point Status and Control Register (FPSCR)	3-28
3-23	Initial Flow for Floating-Point Exception Conditions.....	3-36
3-24	Checking of Remaining Floating-Point Exception Conditions.....	3-40
4-1	Register Indirect with Immediate Index Addressing for Integer Loads/Stores....	4-34
4-2	Register Indirect with Index Addressing for Integer Loads/Stores.....	4-35
4-3	Register Indirect Addressing for Integer Loads/Stores	4-36
4-4	Register Indirect with Immediate Index Addressing for Floating-Point Loads/Stores	4-43
4-5	Register Indirect with Index Addressing for Floating-Point Loads/Stores	4-44
4-6	Branch Relative Addressing.....	4-48
4-7	Branch Conditional Relative Addressing	4-49
4-8	Branch to Absolute Addressing.....	4-49
4-9	Branch Conditional to Absolute Addressing.....	4-50
4-10	Branch Conditional to Link Register Addressing	4-51
4-11	Branch Conditional to Count Register Addressing	4-52
6-1	Machine Status Save/Restore Register 0.....	6-15
6-2	Machine Status Save/Restore Register 1	6-15
6-3	Machine State Register (MSR)—64-Bit Implementation	6-15
6-4	Machine State Register (MSR)—32-Bit Implementation.....	6-16
7-1	MMU Conceptual Block Diagram—64-Bit Implementations	7-9
7-2	MMU Conceptual Block Diagram—32-Bit Implementations	7-11
7-3	Address Translation Types—64-Bit Implementations.....	7-14
7-4	General Flow of Address Translation (Real Addressing Mode and Block)	7-18
7-5	General Flow of Page and Direct-Store Address Translation	7-19

ILLUSTRATIONS

Figure Number	Title	Page Number
7-6	Location of Segment Descriptors	7-21
7-7	BAT Array Organization—64-Bit Implementations.....	7-30
7-8	BAT Array Hit/Miss Flow—64-Bit Implementations	7-32
7-9	Format of Upper BAT Registers—64-Bit Implementations	7-34
7-10	Format of Lower BAT Registers—64-Bit Implementations.....	7-34
7-11	Format of Upper BAT Registers—32-Bit Implementations	7-34
7-12	Format of Lower BAT Registers—32-Bit Implementations.....	7-34
7-13	Memory Protection Violation Flow for Blocks.....	7-39
7-14	Block Physical Address Generation—64-Bit Implementations.....	7-40
7-15	Block Physical Address Generation—32-Bit Implementations.....	7-41
7-16	Block Address Translation Flow—64-Bit Implementations.....	7-42
7-17	Page Address Translation Overview—64-Bit Implementations.....	7-45
7-18	Page Address Translation Overview—32-Bit Implementations.....	7-46
7-19	STE Format—64-Bit Implementations	7-47
7-20	Segment Register Format for Page Address Translation— 32-Bit Implementations	7-49
7-21	Page Table Entry Format—64-Bit Implementations	7-51
7-22	Page Table Entry Format—32-Bit Implementations	7-52
7-23	Memory Protection Violation Flow for Pages	7-60
7-24	Page Address Translation Flow for 64-Bit Implementations—TLB Hit	7-62
7-25	Page Memory Protection Violation Conditions for Page Address Translation ...	7-63
7-26	Page Table Definitions	7-64
7-27	SDR1 Register Format—64-Bit Implementations	7-65
7-28	SDR1 Register Format—32-Bit Implementations	7-66
7-29	Hashing Functions for Page Tables—64-Bit Implementations.....	7-71
7-30	Hashing Functions for Page Tables—32-Bit Implementations.....	7-72
7-31	Generation of Addresses for Page Tables—64-Bit Implementations	7-74
7-32	Generation of Addresses for Page Tables—32-Bit Implementations	7-76
7-33	Example Page Table Structure—64-Bit Implementations	7-79
7-34	Example Page Table Structure—32-Bit Implementations	7-80
7-35	Example Primary PTEG Address Generation—64-Bit Implementation	7-82
7-36	Example Secondary PTEG Address Generation—64-Bit Implementation	7-83
7-37	Example Primary PTEG Address Generation—32-Bit Implementation	7-85
7-38	Example Secondary PTEG Address Generation—32-Bit Implementations	7-86
7-39	Page Table Search Flow	7-90
7-40	Segment Table Definitions.....	7-96
7-41	ASR Format—64-Bit Implementations Only	7-97
7-42	Hashing Functions for Segment Tables	7-99
7-43	Generation of Addresses for Segment Table.....	7-102
7-44	Example Primary STEG Address Generation	7-104
7-45	Example Secondary STEG Address Generation	7-105
7-46	Segment Table Search Flow.....	7-107

ILLUSTRATIONS

Figure Number	Title	Page Number
7-47	Segment Descriptor Format for Direct-Store Segments— 64-Bit Implementations	7-110
7-48	Segment Register Format for Direct-Store Segments— 32-Bit Implementations	7-111
7-49	Direct-Store Segment Translation Flow	7-114
7-50	GPR Contents for mfsr , mfsrin , mtsr , and mtsrin	7-119
7-51	GPR Contents for mtsr and mtsrin	7-121
8-1	Instruction Description	8-9
D-1	IEEE 64-Bit Execution Model	D-1
D-2	Multiply-Add 64-Bit Execution Model	D-4

TABLES

Table Number	Title	Page Number
i	Acronyms and Abbreviated Terms.....	xxxiv
ii	Terminology Conventions.....	xxxvii
iii	Instruction Field Conventions.....	xxxvii
1-1	Optional 64-Bit Bridge Features.....	1-19
1-2	UISA Changes—Rev. 0 to Rev. 0.1.....	1-19
1-3	UISA Changes—Rev. 0.1 to Rev. 1.0.....	1-20
1-4	VEA Changes—Rev. 0 to Rev. 0.1.....	1-20
1-5	VEA Changes—Rev. 0.1 to Rev. 1.0.....	1-20
1-6	OEA Changes—Rev. 0 to Rev. 0.1.....	1-21
1-7	OEA Changes—Rev. 0.1 to Rev. 1.0.....	1-21
2-1	Bit Settings for CR0 Field of CR.....	2-6
2-2	Bit Settings for CR1 Field of CR.....	2-6
2-3	CR n Field Bit Settings for Compare Instructions.....	2-7
2-4	FPSCR Bit Settings.....	2-8
2-5	Floating-Point Result Flags in FPSCR.....	2-10
2-6	XER Bit Definitions.....	2-11
2-7	BO Operand Encodings.....	2-13
2-8	MSR Bit Settings.....	2-21
2-9	Floating-Point Exception Mode Bits.....	2-23
2-10	State of MSR at Power Up.....	2-23
2-11	BAT Registers—Field and Bit Descriptions.....	2-26
2-12	BAT Area Lengths.....	2-27
2-13	SDR1 Bit Settings—64-Bit Implementations.....	2-28
2-14	SDR1 Bit Settings—32-Bit Implementations.....	2-29
2-15	ASR Bit Settings.....	2-30
2-16	ASR Bit Settings—64-Bit Bridge.....	2-31
2-17	Segment Register Bit Settings (T = 0).....	2-32
2-18	Segment Register Bit Settings (T = 1).....	2-32
2-19	Conventional Uses of SPRG0–SPRG3.....	2-34
2-20	DABR—Bit Settings.....	2-38
2-21	External Access Register (EAR) Bit Settings.....	2-40
2-22	Data Access Synchronization.....	2-41
2-23	Instruction Access Synchronization.....	2-42
3-1	Memory Operand Alignment.....	3-2
3-2	EA Modifications.....	3-7
3-3	Performance Effects of Memory Operand Placement, Big-Endian Mode.....	3-13

TABLES

Table Number	Title	Page Number
3-4	Performance Effects of Memory Operand Placement, Little-Endian Mode	3-14
3-5	IEEE Floating-Point Fields.....	3-17
3-6	Biased Exponent Format	3-17
3-7	Recognized Floating-Point Numbers	3-18
3-8	FPSCR Bit Settings—RN Field.....	3-26
3-9	FPSCR Bit Settings	3-29
3-10	Floating-Point Result Flags — FPSCR[FPRF]	3-31
3-11	MSR[FE0] and MSR[FE1] Bit Settings for FP Exceptions	3-34
3-12	Additional Actions Performed for Invalid FP Operations.....	3-38
3-13	Additional Actions Performed for Zero Divide.....	3-39
3-14	Additional Actions Performed for Overflow Exception Condition	3-41
3-15	Target Result for Overflow Exception Disabled Case	3-42
3-16	Actions Performed for Underflow Conditions	3-43
4-1	Integer Arithmetic Instructions.....	4-12
4-2	Integer Compare Instructions	4-18
4-3	Integer Logical Instructions.....	4-19
4-4	Integer Rotate Instructions	4-22
4-5	Integer Shift Instructions	4-24
4-6	Floating-Point Arithmetic Instructions.....	4-26
4-7	Floating-Point Multiply-Add Instructions.....	4-28
4-8	Floating-Point Rounding and Conversion Instructions	4-30
4-9	CR Bit Settings	4-31
4-10	Floating-Point Compare Instructions	4-31
4-11	Floating-Point Status and Control Register Instructions	4-32
4-12	Floating-Point Move Instructions.....	4-33
4-13	Integer Load Instructions.....	4-37
4-14	Integer Store Instructions	4-39
4-15	Integer Load and Store with Byte-Reverse Instructions.....	4-40
4-16	Integer Load and Store Multiple Instructions.....	4-41
4-17	Integer Load and Store String Instructions.....	4-42
4-18	Floating-Point Load Instructions.....	4-44
4-19	Floating-Point Store Instructions.....	4-46
4-20	BO Operand Encodings	4-52
4-21	Branch Instructions.....	4-55
4-22	Condition Register Logical Instructions.....	4-56
4-23	Trap Instructions.....	4-57
4-24	System Linkage Instruction—UISA.....	4-57
4-25	Move to/from Condition Register Instructions.....	4-58
4-26	Move to/from Special-Purpose Register Instructions (UISA).....	4-58
4-27	Memory Synchronization Instructions—UISA	4-60
4-28	Move from Time Base Instruction	4-62
4-29	User-Level TBR Encodings (VEA).....	4-62
4-30	Supervisor-Level TBR Encodings (VEA).....	4-63

TABLES

Table Number	Title	Page Number
4-31	Memory Synchronization Instructions—VEA	4-64
4-32	User-Level Cache Instructions	4-65
4-33	External Control Instructions	4-68
4-34	System Linkage Instructions—OEA	4-69
4-35	Move to/from Machine State Register Instructions.....	4-71
4-36	Move to/from Special-Purpose Register Instructions (OEA).....	4-71
4-37	Cache Management Supervisor-Level Instruction	4-73
4-38	Segment Register Manipulation Instructions	4-74
4-39	Translation Lookaside Buffer Management Instructions	4-76
5-1	Combinations of W, I, and M Bits	5-15
6-1	PowerPC Exception Classifications	6-3
6-2	Exceptions and Conditions—Overview	6-4
6-3	IEEE Floating-Point Program Exception Mode Bits.....	6-10
6-4	Exception Priorities	6-12
6-5	MSR Bit Settings.....	6-16
6-6	MSR Setting Due to Exception	6-22
6-7	System Reset Exception—Register Settings	6-23
6-8	Machine Check Exception—Register Settings	6-25
6-9	DSI Exception—Register Settings	6-27
6-10	ISI Exception—Register Settings.....	6-29
6-11	External Interrupt—Register Settings	6-30
6-12	Alignment Exception—Register Settings.....	6-31
6-13	DSISR(15–21) Settings to Determine Misaligned Instruction.....	6-34
6-14	Program Exception—Register Settings.....	6-37
6-15	Floating-Point Unavailable Exception—Register Settings	6-38
6-16	Decrementer Exception—Register Settings	6-39
6-17	System Call Exception—Register Settings	6-40
6-18	Trace Exception—Register Settings.....	6-41
6-19	Floating-Point Assist Exception—Register Settings.....	6-42
7-1	MMU Features Summary	7-3
7-2	Predefined Physical Memory Locations.....	7-7
7-3	Value of Base for Predefined Memory Use	7-7
7-4	Access Protection Options for Pages.....	7-15
7-5	Translation Exception Conditions	7-23
7-6	Other MMU Exception Conditions	7-24
7-7	Instruction Summary—Control MMU	7-26
7-8	MMU Registers	7-27
7-9	BAT Registers—Field and Bit Descriptions for 64-Bit Implementations	7-35
7-10	Upper BAT Register Block Size Mask Encodings.....	7-36
7-11	Access Protection Control for Blocks	7-37
7-12	Access Protection Summary for BAT Array.....	7-38
7-13	Segment Descriptor Types	7-43
7-14	STE Bit Definitions for Page Address Translation—64-Bit Implementations	7-48

TABLES

Table Number	Title	Page Number
7-15	Segment Register Bit Definition for Page Address Translation— 32-Bit Implementations	7-49
7-16	Segment Register Instructions—32-Bit Implementations	7-50
7-17	PTE Bit Definitions—64-Bit Implementations	7-52
7-18	PTE Bit Definitions—32-Bit Implementations	7-53
7-19	Table Search Operations to Update History Bits	7-54
7-20	Model for Guaranteed R and C Bit Settings.....	7-56
7-21	Access Protection Control with Key	7-58
7-22	. Exception Conditions for Key and PP Combinations	7-59
7-23	Access Protection Encoding of PP Bits for Ks = 0 and Kp = 1.....	7-59
7-24	SDR1 Register Bit Settings—64-Bit Implementations	7-65
7-25	SDR1 Register Bit Settings—32-Bit Implementations	7-67
7-26	Minimum Recommended Page Table Sizes—64-Bit Implementations.....	7-68
7-27	Minimum Recommended Page Table Sizes—32-Bit Implementations.....	7-69
7-28	Segment Descriptor Bit Definitions for Direct-Store Segments— 64-Bit Implementations	7-111
7-29	Segment Register Bit Definitions for Direct-Store Segments.....	7-111
7-30	Contents of rD after Executing mfsr	7-118
7-31	SLB Entry Following mfsrin	7-119
7-32	SLB Entry Following mtsr	7-120
7-33	SLB Entry Following mtsrin	7-121
7-34	SLB Entry Following mtsrdr	7-123
7-35	SLB Entry Following mtsrdrin	7-124
8-1	Split-Field Notation and Conventions	8-2
8-2	Instruction Syntax Conventions	8-2
8-3	Notation and Conventions	8-4
8-4	Instruction Field Conventions	8-7
8-5	Precedence Rules.....	8-8
8-6	BO Operand Encodings	8-24
8-7	BO Operand Encodings	8-26
8-8	BO Operand Encodings	8-28
8-9	PowerPC UISA SPR Encodings for mfspr	8-155
8-10	PowerPC OEA SPR Encodings for mfspr	8-156
8-11	GPR Content Format Following mfsr	8-158
8-12	GPR Content Format Following mfsrin	8-160
8-13	TBR Encodings for mftb	8-162
8-14	PowerPC UISA SPR Encodings for mtspr	8-172
8-15	PowerPC OEA SPR Encodings for mtspr	8-173
8-16	SLB Entry Following mtsr	8-175
8-17	SLB Entry Following mtsrdr	8-177
8-18	SLB Entry following mtsrdrin	8-178
8-19	SLB Entry Following mtsrin	8-180

TABLES

Table Number	Title	Page Number
A-1	Complete Instruction List Sorted by Mnemonic	A-1
A-2	Complete Instruction List Sorted by Opcode	A-9
A-3	Integer Arithmetic Instructions.....	A-17
A-4	Integer Compare Instructions	A-18
A-5	Integer Logical Instructions.....	A-18
A-6	Integer Rotate Instructions	A-19
A-7	Integer Shift Instructions	A-19
A-8	Floating-Point Arithmetic Instructions.....	A-20
A-9	Floating-Point Multiply-Add Instructions.....	A-20
A-10	Floating-Point Rounding and Conversion Instructions	A-21
A-11	Floating-Point Compare Instructions	A-21
A-12	Floating-Point Status and Control Register Instructions	A-21
A-13	Integer Load Instructions.....	A-22
A-14	Integer Store Instructions	A-23
A-15	Integer Load and Store with Byte Reverse Instructions	A-23
A-16	Integer Load and Store Multiple Instructions.....	A-23
A-17	Integer Load and Store String Instructions.....	A-24
A-18	Memory Synchronization Instructions	A-24
A-19	Floating-Point Load Instructions.....	A-24
A-20	Floating-Point Store Instructions.....	A-25
A-21	Floating-Point Move Instructions.....	A-25
A-22	Branch Instructions.....	A-25
A-23	Condition Register Logical Instructions.....	A-26
A-24	System Linkage Instructions	A-26
A-25	Trap Instructions.....	A-26
A-26	Processor Control Instructions	A-27
A-27	Cache Management Instructions	A-27
A-28	Segment Register Manipulation Instructions.	A-28
A-29	Lookaside Buffer Management Instructions	A-28
A-30	External Control Instructions	A-28
A-31	I-Form.....	A-29
A-32	B-Form	A-29
A-33	SC-Form	A-29
A-34	D-Form	A-29
A-35	DS-Form	A-31
A-36	X-Form	A-31
A-37	XL-Form.....	A-36
A-38	XFX-Form	A-36
A-39	XFL-Form.....	A-37
A-40	XS-Form	A-37
A-41	XO-Form	A-37
A-42	A-Form	A-38
A-43	M-Form.....	A-39

TABLES

Table Number	Title	Page Number
A-44	MD-Form.....	A-39
A-45	MDS-Form	A-40
A-46	PowerPC Instruction Set Legend.....	A-41
B-1	Condition Register Settings.....	B-2
B-2	Deleted POWER Instructions.....	B-9
B-3	POWER Instructions Implemented in PowerPC Architecture.....	B-11
D-1	Interpretation of G, R, and X Bits	D-2
D-2	Location of the Guard, Round, and Sticky Bits—IEEE Execution Model	D-3
D-3	Location of the Guard, Round, and Sticky Bits— Multiply-Add Execution Model	D-4
F-1	Condition Register Bit and Identification Symbol Descriptions	F-1
F-2	Simplified Mnemonics for Double-Word Compare Instructions.....	F-3
F-3	Simplified Mnemonics for Word Compare Instructions	F-4
F-4	Double-Word Rotate and Shift Instructions	F-5
F-5	Word Rotate and Shift Instructions	F-6
F-6	Simplified Branch Mnemonics.....	F-8
F-7	Simplified Branch Mnemonics for bc and bca Instructions without Link Register Update	F-9
F-8	Simplified Branch Mnemonics for bclr and bclr Instructions without Link Register Update	F-10
F-9	Simplified Branch Mnemonics for bcl and bcla Instructions with Link Register Update.....	F-11
F-10	Simplified Branch Mnemonics for bclrl and bctrl Instructions with Link Register Update.....	F-12
F-11	Standard Coding for Branch Conditions	F-13
F-12	Simplified Branch Mnemonics with Comparison Conditions.....	F-14
F-13	Simplified Branch Mnemonics for bc and bca Instructions without Comparison Conditions and Link Register Updating	F-15
F-14	Simplified Branch Mnemonics for bclr and bctrl Instructions without Comparison Conditions and Link Register Updating	F-16
F-15	Simplified Branch Mnemonics for bcl and bcla Instructions with Comparison Conditions and Link Register Update.....	F-17
F-16	Simplified Branch Mnemonics for bclrl and bctrl Instructions with Comparison Conditions and Link Register Update.....	F-18
F-17	Condition Register Logical Mnemonics.....	F-19
F-18	Standard Codes for Trap Instructions.....	F-20
F-19	Trap Mnemonics.....	F-21
F-20	TO Operand Bit Encoding.....	F-22
F-21	Simplified Mnemonics for SPRs.....	F-22

About This Book

The primary objective of this manual is to help programmers provide software that is compatible across the family of PowerPC™ processors. Because the PowerPC architecture is designed to be flexible to support a broad range of processors, this book provides a general description of features that are common to PowerPC processors and indicates those features that are optional or that may be implemented differently in the design of each processor.

This revision of this book describes both the 64- and the 32-bit portions of the PowerPC architecture from the perspective of the 64-bit architecture. The information in this manual that pertains only to the 32-bit architecture is presented in *PowerPC Microprocessor Family: The Programming Environments for 32-Bit Microprocessors*. Both books reflect changes to the PowerPC architecture made subsequent to the publication of *PowerPC Microprocessor Family: The Programming Environments*, Rev. 0 and Rev. 0.1.

To locate any published errata or updates for this document, refer to the world-wide web at <http://www.mot.com/powerpc/> or at <http://www.chips.ibm.com/products/ppc>.

For designers working with a specific processor, this book should be used in conjunction with the user's manual for that processor. For information regarding variances between a processor implementation and the version of the PowerPC architecture reflected in this document, see the reference to *Implementation Variances Relative to Rev. 1 of The Programming Environments Manual* described in "PowerPC Documentation," on Page xxxi.

This document distinguishes between the three levels, or programming environments, of the PowerPC architecture, which are as follows:

- PowerPC user instruction set architecture (UISA)—The UISA defines the level of the architecture to which user-level software should conform. The UISA defines the base user-level instruction set, user-level registers, data types, memory conventions, and the memory and programming models seen by application programmers.
- PowerPC virtual environment architecture (VEA)—The VEA, which is the smallest component of the PowerPC architecture, defines additional user-level functionality that falls outside typical user-level software requirements. The VEA describes the memory model for an environment in which multiple processors or other devices can access external memory, and defines aspects of the cache model and cache control instructions from a user-level perspective. The resources defined by the VEA are

particularly useful for optimizing memory accesses and for managing resources in an environment in which other processors and other devices can access external memory.

Implementations that conform to the PowerPC VEA also adhere to the UISA, but may not necessarily adhere to the OEA.

- PowerPC operating environment architecture (OEA)—The OEA defines supervisor-level resources typically required by an operating system. The OEA defines the PowerPC memory management model, supervisor-level registers, and the exception model.

Implementations that conform to the PowerPC OEA also conform to the PowerPC UISA and VEA.

TEMPORARY 64-BIT BRIDGE

The OEA also defines optional features to simplify the migration of 32-bit operating systems to 64-bit implementations.

It is important to note that some resources are defined more generally at one level in the architecture and more specifically at another. For example, conditions that can cause a floating-point exception are defined by the UISA, while the exception mechanism itself is defined by the OEA.

Because it is important to distinguish between the levels of the architecture in order to ensure compatibility across multiple platforms, those distinctions are shown clearly throughout this book. The level of the architecture to which text refers is indicated in the outer margin, using the conventions shown in “Conventions,” on Page xxxiii.

This book does not attempt to replace the PowerPC architecture specification, which defines the architecture from the perspective of the three programming environments and which remains the defining document for the PowerPC architecture. This book reflects changes made to the architecture before August 6, 1996. These changes are described in Section 1.3, “Changes in This Revision of The Programming Environments Manual.” For information about the architecture specification, see “General Information,” on Page xxx.

For ease in reference, this book and the processor user’s manuals have arranged the architecture information into topics that build upon one another, beginning with a description and complete summary of registers and instructions (for all three environments) and progressing to more specialized topics such as the cache, exception, and memory management models. As such, chapters may include information from multiple levels of the architecture; for example, the discussion of the cache model uses information from both the VEA and the OEA.

It is beyond the scope of this manual to describe individual PowerPC processors. It must be kept in mind that each PowerPC processor is unique in its implementation of the PowerPC architecture.

The information in this book is subject to change without notice, as described in the disclaimers on the title page of this book. As with any technical documentation, it is the readers' responsibility to be sure they are using the most recent version of the documentation. For more information, contact your sales representative.

Audience

This manual is intended for system software and hardware developers and application programmers who want to develop products for the PowerPC processors in general. It is assumed that the reader understands operating systems, microprocessor system design, and the basic principles of RISC processing.

This revision of this book describes both the 64- and the 32-bit portions of the PowerPC architecture, primarily from the perspective of the 64-bit architectural definition. The information in this manual that pertains only to the 32-bit architecture is also presented separately in *PowerPC Microprocessor Family: The Programming Environments for 32-Bit Microprocessors*.

Organization

Following is a summary and a brief description of the major sections of this manual:

- Chapter 1, “Overview,” is useful for those who want a general understanding of the features and functions of the PowerPC architecture. This chapter describes the flexible nature of the PowerPC architecture definition and provides an overview of how the PowerPC architecture defines the register set, operand conventions, addressing modes, instruction set, cache model, exception model, and memory management model.
- Chapter 2, “PowerPC Register Set,” is useful for software engineers who need to understand the PowerPC programming model for the three programming environments and the functionality of the PowerPC registers.
- Chapter 3, “Operand Conventions,” describes PowerPC conventions for storing data in memory, including information regarding alignment, single- and double-precision floating-point conventions, and big- and little-endian byte ordering.
- Chapter 4, “Addressing Modes and Instruction Set Summary,” provides an overview of the PowerPC addressing modes and a description of the PowerPC instructions. Instructions are organized by function.
- Chapter 5, “Cache Model and Memory Coherency,” provides a discussion of the cache and memory model defined by the VEA and aspects of the cache model that are defined by the OEA.
- Chapter 6, “Exceptions,” describes the exception model defined in the OEA.
- Chapter 7, “Memory Management,” provides descriptions of the PowerPC address translation and memory protection mechanism as defined by the OEA.

- Chapter 8, “Instruction Set,” functions as a handbook for the PowerPC instruction set. Instructions are sorted by mnemonic. Each instruction description includes the instruction formats and an individualized legend that provides such information as the level(s) of the PowerPC architecture in which the instruction may be found and the privilege level of the instruction.
- Appendix A, “PowerPC Instruction Set Listings,” lists all the PowerPC instructions. Instructions are grouped according to mnemonic, opcode, function, and form.
- Appendix B, “POWER Architecture Cross Reference,” identifies the differences that must be managed in migration from the POWER architecture to the PowerPC architecture.
- Appendix C, “Multiple-Precision Shifts,” describes how multiple-precision shift operations can be programmed as defined by the UISA.
- Appendix D, “Floating-Point Models,” gives examples of how the floating-point conversion instructions can be used to perform various conversions as described in the UISA.
- Appendix E, “Synchronization Programming Examples,” gives examples showing how synchronization instructions can be used to emulate various synchronization primitives and how to provide more complex forms of synchronization.
- Appendix F, “Simplified Mnemonics,” provides a set of simplified mnemonic examples and symbols.
- This manual also includes a glossary and an index.

Suggested Reading

This section lists additional reading that provides background for the information in this manual as well as general information about the PowerPC architecture.

General Information

The following documentation provides useful information about the PowerPC architecture and computer architecture in general:

- The following books are available from the Morgan-Kaufmann Publishers, 340 Pine Street, Sixth Floor, San Francisco, CA 94104; Tel. (800) 745-7323 (U.S.A.), (415) 392-2665 (International); internet address: mkp@mkp.com.
 - *The PowerPC Architecture: A Specification for a New Family of RISC Processors*, Second Edition, by International Business Machines, Inc.
Updates to the architecture specification are accessible via the world-wide web at <http://www.austin.ibm.com/tech/ppc-chg.html>.
 - *PowerPC Microprocessor Common Hardware Reference Platform: A System Architecture*, by Apple Computer, Inc., International Business Machines, Inc., and Motorola, Inc.

- *Macintosh Technology in the Common Hardware Reference Platform*, by Apple Computer, Inc.
- *Computer Architecture: A Quantitative Approach*, Second Edition, by John L. Hennessy and David A. Patterson,
- *Inside Macintosh: PowerPC System Software*, Addison-Wesley Publishing Company, One Jacob Way, Reading, MA, 01867; Tel. (800) 282-2732 (U.S.A.), (800) 637-0029 (Canada), (716) 871-6555 (International).
- *PowerPC Programming for Intel Programmers*, by Kip McClanahan; IDG Books Worldwide, Inc., 919 East Hillsdale Boulevard, Suite 400, Foster City, CA, 94404; Tel. (800) 434-3422 (U.S.A.), (415) 655-3022 (International).

PowerPC Documentation

The PowerPC documentation is organized in the following types of documents:

- User's manuals—These books provide details about individual PowerPC implementations and are intended to be used in conjunction with *The Programming Environments Manual*. These include the following:
 - *PowerPC 601™ RISC Microprocessor User's Manual*: MPC601UM/AD (Motorola order #) and 52G7484/(MPR601UMU-02) (IBM order #)
 - *PowerPC 602™ RISC Microprocessor User's Manual*: MPC602UM/AD (Motorola order #) and MPR602UM-01 (IBM order #)
 - *PowerPC 603e™ RISC Microprocessor User's Manual with Supplement for PowerPC 603 Microprocessor*: MPC603EUM/AD (Motorola order #) and MPR603EUM-01 (IBM order #)
 - *PowerPC 604™ RISC Microprocessor User's Manual*: MPC604UM/AD (Motorola order #) and MPR604UMU-01 (IBM order #)
- *Implementation Variances Relative to Rev. 1 of The Programming Environments Manual* is available via the world-wide web at <http://www.mot.com/powerpc/> or at <http://www.chips.ibm.com/products/ppc>.
- Addenda/errata to user's manuals—Because some processors have follow-on parts an addendum is provided that describes the additional features and changes to functionality of the follow-on part. These addenda are intended for use with the corresponding user's manuals. These include the following:
 - *Addendum to PowerPC 603e RISC Microprocessor User's Manual: PowerPC 603e Microprocessor Supplement and User's Manual Errata*: MPC603EUMAD/AD (Motorola order #) and SA14-2034-00 (IBM order #)
 - *Addendum to PowerPC 604 RISC Microprocessor User's Manual: PowerPC 604e™ Microprocessor Supplement and User's Manual Errata*: MPC604UMAD/AD (Motorola order #) and SA14-2056-01 (IBM order #)

- Hardware specifications—Hardware specifications provide specific data regarding bus timing, signal behavior, and AC, DC, and thermal characteristics, as well as other design considerations for each PowerPC implementation. These include the following:
 - *PowerPC 601 RISC Microprocessor Hardware Specifications:* MPC601EC/D (Motorola order #) and MPR601HSU-03 (IBM order #)
 - *PowerPC 602 RISC Microprocessor Hardware Specifications:* MPC602EC/D (Motorola order #) and SC229897-00 (IBM order #)
 - *PowerPC 603 RISC Microprocessor Hardware Specifications:* MPC603EC/D (Motorola order #) and MPR603HSU-03 (IBM order #)
 - *PowerPC 603e RISC Microprocessor Family: PID6-603e Hardware Specifications:* MPC603EEC/D (Motorola order #) and G522-0268-00 (IBM order #)
 - *PowerPC 603e RISC Microprocessor Family: PID7V-603e Hardware Specifications:* MPC603E7VEC/D (Motorola order #) and G522-0267-00 (IBM order #)
 - *PowerPC 604 RISC Microprocessor Hardware Specifications:* MPC604EC/D (Motorola order #) and MPR604HSU-02 (IBM order #)
 - *PowerPC 604e RISC Microprocessor Family: PID9V-604e Hardware Specifications:* MPC604E9VEC/D (Motorola order #) and SA14-2054-00 (IBM order #)
- Technical Summaries—Each PowerPC implementation has a technical summary that provides an overview of its features. This document is roughly the equivalent to the overview (Chapter 1) of an implementation's user's manual. Technical summaries are available for the 601, 602, 603, 603e, 604, and 604e as well as the following:
 - *PowerPC 620™ RISC Microprocessor Technical Summary:* MPC620/D (Motorola order #) and SA14-2069-01 (IBM order #)
- *PowerPC Microprocessor Family: The Bus Interface for 32-Bit Microprocessors:* MPCBUSIF/AD (Motorola order #) and G522-0291-00 (IBM order #) provides a detailed functional description of the 60x bus interface, as implemented on the 601, 603, and 604 family of PowerPC microprocessors. This document is intended to help system and chipset developers by providing a centralized reference source to identify the bus interface presented by the 60x family of PowerPC microprocessors.
- *PowerPC Microprocessor Family: The Programmer's Reference Guide:* MPCPRG/D (Motorola order #) and MPRPPCPRG-01 (IBM order #) is a concise reference that includes the register summary, memory control model, exception vectors, and the PowerPC instruction set.

- *PowerPC Microprocessor Family: The Programmer's Pocket Reference Guide: MPCPRGREF/D* (Motorola order #) and SA14-2093-00 (IBM order #): This foldout card provides an overview of the PowerPC registers, instructions, and exceptions for 32-bit implementations.
- Application notes—These short documents contain useful information about specific design issues useful to programmers and engineers working with PowerPC processors.
- Documentation for support chips—These include the following:
 - *MPC105 PCI Bridge/Memory Controller User's Manual: MPC105UM/AD* (Motorola order #)
 - *MPC106 PCI Bridge/Memory Controller User's Manual: MPC106UM/AD* (Motorola order #)

Additional literature on PowerPC implementations is being released as new processors become available. For a current list of PowerPC documentation, refer to the world-wide web at <http://www.mot.com/powerpc/> or at <http://www.chips.ibm.com/products/ppc>.

Conventions

This document uses the following notational conventions:

mnemonics	Instruction mnemonics are shown in lowercase bold.
<i>italics</i>	Italics indicate variable command parameters, for example, bcctrx . Book titles in text are set in italics.
0x0	Prefix to denote hexadecimal number
0b0	Prefix to denote binary number
rA, rB	Instruction syntax used to identify a source GPR
rD	Instruction syntax used to identify a destination GPR
frA, frB, frC	Instruction syntax used to identify a source FPR
frD	Instruction syntax used to identify a destination FPR
REG[FIELD]	Abbreviations or acronyms for registers are shown in uppercase text. Specific bits, fields, or ranges appear in brackets. For example, MSR[LE] refers to the little-endian mode enable bit in the machine state register.
x	In certain contexts, such as a signal encoding, this indicates a don't care.
<i>n</i>	Used to express an undefined numerical value
¬	NOT logical operator
&	AND logical operator
	OR logical operator

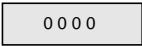
- U This symbol identifies text that is relevant with respect to the PowerPC user instruction set architecture (UISA). This symbol is used both for information that can be found in the UISA specification as well as for explanatory information related to that programming environment.
- V This symbol identifies text that is relevant with respect to the PowerPC virtual environment architecture (VEA). This symbol is used both for information that can be found in the VEA specification as well as for explanatory information related to that programming environment.
- O This symbol identifies text that is relevant with respect to the PowerPC operating environment architecture (OEA). This symbol is used both for information that can be found in the OEA specification as well as for explanatory information related to that programming environment.
-  Indicates reserved bits or bit fields in a register. Although these bits may be written to as either ones or zeroes, they are always read as zeros.

TEMPORARY 64-BIT BRIDGE

Text that pertains to the optional 64-bit bridge defined by the OEA is presented with a grayed background, as shown here.

Additional conventions used with instruction encodings are described in Table 8-2 on page 8-2. Conventions used for pseudocode examples are described in Table 8-3 on page 8-4.

Acronyms and Abbreviations

Table i contains acronyms and abbreviations that are used in this document. Note that the meanings for some acronyms (such as SDR1 and XER) are historical, and the words for which an acronym stands may not be intuitively obvious.

Table i. Acronyms and Abbreviated Terms

Term	Meaning
ALU	Arithmetic logic unit
ASR	Address space register
BAT	Block address translation
BIST	Built-in self test
BPU	Branch processing unit
BUID	Bus unit ID
CR	Condition register

Table i. Acronyms and Abbreviated Terms (Continued)

Term	Meaning
CTR	Count register
DABR	Data address breakpoint register
DAR	Data address register
DBAT	Data BAT
DEC	Decrementer register
DSISR	Register used for determining the source of a DSI exception
DTLB	Data translation lookaside buffer
EA	Effective address
EAR	External access register
ECC	Error checking and correction
FPECR	Floating-point exception cause register
FPR	Floating-point register
FPSCR	Floating-point status and control register
FPU	Floating-point unit
GPR	General-purpose register
IBAT	Instruction BAT
IEEE	Institute of Electrical and Electronics Engineers
ITLB	Instruction translation lookaside buffer
IU	Integer unit
L2	Secondary cache
LIFO	Last-in-first-out
LR	Link register
LRU	Least recently used
LSB	Least-significant byte
lsb	Least-significant bit
MESI	Modified/exclusive/shared/invalid—cache coherency protocol
MMU	Memory management unit
MSB	Most-significant byte
msb	Most-significant bit
MSR	Machine state register
NaN	Not a number
NIA	Next instruction address

Table i. Acronyms and Abbreviated Terms (Continued)

Term	Meaning
No-op	No operation
OEA	Operating environment architecture
PIR	Processor identification register
PTE	Page table entry
PTEG	Page table entry group
PVR	Processor version register
RISC	Reduced instruction set computing
RTL	Register transfer language
RWITM	Read with intent to modify
SDR1	Register that specifies the page table base address for virtual-to-physical address translation
SIMM	Signed immediate value
SLB	Segment lookaside buffer
SPR	Special-purpose register
SPRG _n	Registers available for general purposes
SR	Segment register
SRR0	Machine status save/restore register 0
SRR1	Machine status save/restore register 1
STE	Segment table entry
TB	Time base register
TLB	Translation lookaside buffer
UIMM	Unsigned immediate value
UISA	User instruction set architecture
VA	Virtual address
VEA	Virtual environment architecture
XATC	Extended address transfer code
XER	Register used primarily for indicating conditions such as carries and overflows for integer operations

Terminology Conventions

Table ii lists certain terms used in this manual that differ from the architecture terminology conventions.

Table ii. Terminology Conventions

The Architecture Specification	This Manual
Data storage interrupt (DSI)	DSI exception
Extended mnemonics	Simplified mnemonics
Instruction storage interrupt (ISI)	ISI exception
Interrupt	Exception
Privileged mode (or privileged state)	Supervisor-level privilege
Problem mode (or problem state)	User-level privilege
Real address	Physical address
Relocation	Translation
Storage (locations)	Memory
Storage (the act of)	Access

Table iii describes instruction field notation conventions used in this manual.

Table iii. Instruction Field Conventions

The Architecture Specification	Equivalent to:
BA, BB, BT	crbA, crbB, crbD (respectively)
BF, BFA	crfD, crfS (respectively)
D	d
DS	ds
FLM	FM
FRA, FRB, FRC, FRT, FRS	frA, frB, frC, frD, frS (respectively)
FXM	CRM
RA, RB, RT, RS	rA, rB, rD, rS (respectively)
SI	SIMM
U	IMM
UI	UIMM
<i>I, II, III</i>	0...0 (shaded)

Chapter 1

Overview

The PowerPC™ architecture provides a software model that ensures software compatibility among implementations of the PowerPC family of microprocessors. In this document, and in other PowerPC documentation as well, the term ‘implementation’ refers to a hardware device (typically a microprocessor) that complies with the specifications defined by the architecture.

In general, the architecture defines the following:

- **Instruction set**—The instruction set specifies the families of instructions (such as load/store, integer arithmetic, and floating-point arithmetic instructions), the specific instructions, and the forms used for encoding the instructions. The instruction set definition also specifies the addressing modes used for accessing memory.
- **Programming model**—The programming model defines the register set and the memory conventions, including details regarding the bit and byte ordering, and the conventions for how data (such as integer and floating-point values) are stored.
- **Memory model**—The memory model defines the size of the address space and of the subdivisions (pages and blocks) of that address space. It also defines the ability to configure pages and blocks of memory with respect to caching, byte ordering (big- or little-endian), coherency, and various types of memory protection.
- **Exception model**—The exception model defines the common set of exceptions and the conditions that can generate those exceptions. The exception model specifies characteristics of the exceptions, such as whether they are precise or imprecise, synchronous or asynchronous, and maskable or nonmaskable. The exception model defines the exception vectors and a set of registers used when exceptions are taken. The exception model also provides memory space for implementation-specific exceptions. (Note that exceptions are referred to as interrupts in the architecture specification.)
- **Memory management model**—The memory management model defines how memory is partitioned, configured, and protected. The memory management model also specifies how memory translation is performed, the real, virtual, and physical address spaces, special memory control instructions, and other characteristics. (Physical address is referred to as real address in the architecture specification.)

- Time-keeping model—The time-keeping model defines facilities that permit the time of day to be determined and the resources and mechanisms required for supporting time-related exceptions.

These aspects of the PowerPC architecture are defined at different levels of the architecture, and this chapter provides an overview of those levels—the user instruction set architecture (UISA), the virtual environment architecture (VEA), and the operating environment architecture (OEA).

To locate any published errata or updates for this document, refer to the website at <http://www.mot.com/powerpc/> or at <http://www.chips.ibm.com/products/ppc>.

1.1 PowerPC Architecture Overview

The PowerPC architecture, developed jointly by Motorola, IBM, and Apple Computer, is based on the POWER architecture implemented by RS/6000™ family of computers. The PowerPC architecture takes advantage of recent technological advances in such areas as process technology, compiler design, and reduced instruction set computing (RISC) microprocessor design to provide software compatibility across a diverse family of implementations, primarily single-chip microprocessors, intended for a wide range of systems, including battery-powered personal computers; embedded controllers; high-end scientific and graphics workstations; and multiprocessing, microprocessor-based mainframes.

To provide a single architecture for such a broad assortment of processor environments, the PowerPC architecture is both flexible and scalable.

The flexibility of the PowerPC architecture offers many price/performance options. Designers can choose whether to implement architecturally-defined features in hardware or in software. For example, a processor designed for a high-end workstation has greater need for the performance gained from implementing floating-point normalization and denormalization in hardware than a battery-powered, general-purpose computer might.

The PowerPC architecture is scalable to take advantage of continuing technological advances—for example, the continued miniaturization of transistors makes it more feasible to implement more execution units and a richer set of optimizing features without being constrained by the architecture.

The PowerPC architecture defines the following features:

- Separate 32-entry register files for integer and floating-point instructions. The general-purpose registers (GPRs) hold source data for integer arithmetic instructions, and the floating-point registers (FPRs) hold source and target data for floating-point arithmetic instructions.
- Instructions for loading and storing data between the memory system and either the FPRs or GPRs

- Uniform-length instructions to allow simplified instruction pipelining and parallel processing instruction dispatch mechanisms
- Nondestructive use of registers for arithmetic instructions in which the second, third, and sometimes the fourth operand, typically specify source registers for calculations whose results are typically stored in the target register specified by the first operand.
- A precise exception model (with the option of treating floating-point exceptions imprecisely)
- Floating-point support that includes IEEE-754 floating-point operations
- A flexible architecture definition that allows certain features to be performed in either hardware or with assistance from implementation-specific software depending on the needs of the processor design
- The ability to perform both single- and double-precision floating-point operations
- User-level instructions for explicitly storing, flushing, and invalidating data in the on-chip caches. The architecture also defines special instructions (cache block touch instructions) for speculatively loading data before it is needed, reducing the effect of memory latency.
- Definition of a memory model that allows weakly-ordered memory accesses. This allows bus operations to be reordered dynamically, which improves overall performance and in particular reduces the effect of memory latency on instruction throughput.
- Support for separate instruction and data caches (Harvard architecture) and for unified caches
- Support for both big- and little-endian addressing modes
- Support for 64-bit addressing. The architecture supports both 32-bit or 64-bit implementations. This document typically describes the architecture in terms of the 64-bit implementations in those cases where the 32-bit subset can be easily deduced. Additional information regarding the 32-bit definition is provided where needed.

This chapter provides an overview of the major characteristics of the PowerPC architecture in the order in which they are addressed in this book:

- Register set and programming model
- Instruction set and addressing modes
- Cache implementations
- Exception model
- Memory management

1.1.1 The 64-Bit PowerPC Architecture and the 32-Bit Subset

The PowerPC architecture is a 64-bit architecture with a 32-bit subset. It is important to distinguish the following modes of operations:

- 64-bit implementations/64-bit mode—The PowerPC architecture provides 64-bit addressing, 64-bit integer data types, and instructions that perform arithmetic operations on those data types, as well as other features to support the wider addressing range. For example, memory management differs somewhat between 32- and 64-bit processors. The processor is configured to operate in 64-bit mode by setting a bit in the machine state register (MSR).
- Processors that implement only the 32-bit portion of the PowerPC architecture provide 32-bit effective addresses, which is also the maximum size of integer data types.
- 64-bit implementations/32-bit mode—For compatibility with 32-bit implementations, 64-bit implementations can be configured to operate in 32-bit mode by clearing the MSR[SF] bit. In 32-bit mode, the effective address is treated as a 32-bit address, condition bits, such as overflow and carry bits, are set based on 32-bit arithmetic (for example, integer overflow occurs when the result exceeds 32 bits), and the count register (CTR) is tested by branch conditional instructions following conventions for 32-bit implementations. All applications written for 32-bit implementations will run without modification on 64-bit processors running in 32-bit mode.

This book describes the full 64-bit architecture (for example, instructions are described from a 64-bit perspective). In most cases, details of the 32-bit subset can easily be determined from the 64-bit descriptions. Significant differences in the 32-bit subset are highlighted and described separately as they occur.

TEMPORARY 64-BIT BRIDGE

The OEA defines an additional, optional bridge that may make it easier to migrate a 32-bit operating system to the 64-bit architecture. This bridge allows 64-bit implementations to retain certain aspects of the 32-bit architecture that otherwise are not supported, and in some cases not permitted, by the 64-bit architecture. These resources are summarized in Section 1.3.1, “Changes Related to the Optional 64-Bit Bridge,” and are described more fully in Section 7.9, “Migration of Operating Systems from 32-Bit Implementations to 64-Bit Implementations.”

These resources are not to be considered a permanent part of the PowerPC architecture.

1.1.2 The Levels of the PowerPC Architecture

The PowerPC architecture is defined in three levels that correspond to three programming environments, roughly described from the most general, user-level instruction set environment, to the more specific, operating environment.

This layering of the architecture provides flexibility, allowing degrees of software compatibility across a wide range of implementations. For example, an implementation such as an embedded controller may support the user instruction set, whereas it may be impractical for it to adhere to the memory management, exception, and cache models.

The three levels of the PowerPC architecture are defined as follows:

- PowerPC user instruction set architecture (UISA)—The UISA defines the level of the architecture to which user-level (referred to as problem state in the architecture specification) software should conform. The UISA defines the base user-level instruction set, user-level registers, data types, floating-point memory conventions and exception model as seen by user programs, and the memory and programming models. The icon shown in the margin identifies text that is relevant with respect to the UISA. U
- PowerPC virtual environment architecture (VEA)—The VEA defines additional user-level functionality that falls outside typical user-level software requirements. The VEA describes the memory model for an environment in which multiple devices can access memory, defines aspects of the cache model, defines cache control instructions, and defines the time base facility from a user-level perspective. The icon shown in the margin identifies text that is relevant with respect to the VEA. Implementations that conform to the PowerPC VEA also adhere to the UISA, but may not necessarily adhere to the OEA. V
- PowerPC operating environment architecture (OEA)—The OEA defines supervisor-level (referred to as privileged state in the architecture specification) resources typically required by an operating system. The OEA defines the PowerPC memory management model, supervisor-level registers, synchronization requirements, and the exception model. The OEA also defines the time base feature from a supervisor-level perspective. The icon shown in the margin identifies text that is relevant with respect to the OEA. O

Implementations that conform to the PowerPC OEA also conform to the PowerPC UISA and VEA.

TEMPORARY 64-BIT BRIDGE

The OEA defines an additional, optional bridge that may make it easier to migrate a 32-bit operating system to the 64-bit architecture. This bridge allows 64-bit implementations to use a simpler memory management model to access 32-bit effective address space. Processors that implement this bridge may implement resources, such as instructions, that are not supported, and in some cases not permitted by the 64-bit architecture.

For processors that implement the address translation portion of the bridge, segment descriptors take the form of the STEs defined for 64-bit MMUs; however, only 16 STEs are required to define the entire 4-Gbyte address space. Like 32-bit implementations, the effective address space is entirely defined by 16 contiguous 256-Mbyte segment descriptors. Rather than using the set of 16, 32-bit segment registers as is defined for the 32-bit MMU, the 16 STEs are implemented and are maintained in 16 SLB entries.

Implementations that adhere to the VEA level are guaranteed to adhere to the UISA level; likewise, implementations that conform to the OEA level are also guaranteed to conform to the UISA and the VEA levels.

All PowerPC devices adhere to the UISA, offering compatibility among all PowerPC application programs. However, there may be different versions of the VEA and OEA than those described here. For example, some devices, such as embedded controllers, may not require some of the features as defined by this VEA and OEA, and may implement a simpler or modified version of those features.

The general-purpose PowerPC microprocessors developed jointly by Motorola and IBM (such as the PowerPC 601™, PowerPC 603™, PowerPC 603e™, PowerPC 604™, PowerPC 604e™, and PowerPC 620™ microprocessors) comply both with the UISA and with the VEA and OEA discussed here. In this book, these three levels of the architecture are referred to collectively as the PowerPC architecture.

The distinctions between the levels of the PowerPC architecture are maintained clearly throughout this document, using the conventions described in the section “Conventions” on page xxxiii of the Preface.

1.1.3 Latitude Within the Levels of the PowerPC Architecture

The PowerPC architecture defines those parameters necessary to ensure compatibility among PowerPC processors, but also allows a wide range of options for individual implementations. These are as follows:

- The PowerPC architecture defines some facilities (such as registers, bits within registers, instructions, and exceptions) as optional.
- The PowerPC architecture allows implementations to define additional privileged special-purpose registers (SPRs), exceptions, and instructions for special system requirements (such as power management in processors designed for very low-power operation).
- There are many other parameters that the PowerPC architecture allows implementations to define. For example, the PowerPC architecture may define conditions for which an exception may be taken, such as alignment conditions. A particular implementation may choose to solve the alignment problem without taking the exception.
- Processors may implement any architectural facility or instruction with assistance from software (that is, they may trap and emulate) as long as the results (aside from performance) are identical to that specified by the architecture.
- Some parameters are defined at one level of the architecture and defined more specifically at another. For example, the UISA defines conditions that may cause an alignment exception, and the OEA specifies the exception itself.

Because of updates to the PowerPC architecture specification, which are described in this document, variances may result between existing devices and the revised architecture specification. Those variances are included in *Implementation Variances Relative to Rev. 1 of The Programming Environments Manual*.

1.1.4 Features Not Defined by the PowerPC Architecture

Because flexibility is an important design goal of the PowerPC architecture, there are many aspects of the processor design, typically relating to the hardware implementation, that the PowerPC architecture does not define, such as the following:

- System bus interface signals—Although numerous implementations may have similar interfaces, the PowerPC architecture does not define individual signals or the bus protocol. For example, the OEA allows each implementation to determine the signal or signals that trigger the machine check exception.
- Cache design—The PowerPC architecture does not define the size, structure, the replacement algorithm, or the mechanism used for maintaining cache coherency. The PowerPC architecture supports, but does not require, the use of separate instruction and data caches. Likewise, the PowerPC architecture does not specify the method by which cache coherency is ensured.
- The number and the nature of execution units—The PowerPC architecture is a RISC architecture, and as such has been designed to facilitate the design of processors that use pipelining and parallel execution units to maximize instruction throughput. However, the PowerPC architecture does not define the internal hardware details of implementations. For example, one processor may execute load and store operations in the integer unit, while another may execute these instructions in a dedicated load/store unit.
- Other internal microarchitecture issues—The PowerPC architecture does not prescribe which execution unit is responsible for executing a particular instruction; it also does not define details regarding the instruction fetching mechanism, how instructions are decoded and dispatched, and how results are written back. Dispatch and write-back may occur in order or out of order. Also while the architecture specifies certain registers, such as the GPRs and FPRs, implementations can implement register renaming or other schemes to reduce the impact of data dependencies and register contention.

1.1.5 Summary of Architectural Changes in this Revision

This revision of *The Programming Environments Manual* reflects enhancements to the architecture that have been made since the publication of the *PowerPC Microprocessor Family: The Programming Environments*, Rev. 0.1.

The primary differences described in this document are as follows:

- Addition of the **rfd** and **mtmsrd** instructions to the 64-bit portion of the architecture. The **rfi** and **mtmsr** instructions are now legal in 32-bit processors and illegal in 64-bit processors. Likewise, the **rfd** and **mtmsrd** are valid instructions only in 64-bit processors and are illegal in 32-bit processors.

TEMPORARY 64-BIT BRIDGE

- Addition of several optional and temporary features to facilitate migration of operating systems from 32-bit to 64-bit processors. These include the following:
 - Additional bit in the address space register (ASR[V]) that indicates whether the starting address in the segment table is valid. If this bit is implemented, the following instructions can optionally be implemented:
 - Ability to execute **mtsr**, **mfsr**, **mtsrin**, and **mfsrin** instructions in 64-bit implementations that support the architectural bridge. Otherwise, these instructions, which are defined for the 32-bit implementations, are illegal in 64-bit implementations. Note that 64-bit processors that implement these instructions do not implement actual segment registers as defined by the 32-bit architecture, but rather must provide 16 segment lookaside buffers (SLBs) that contain STE entries that define the entire 32-bit effective address space. The **mtsr** and **mfsr** instructions also are redefined slightly to accommodate the emulated segment registers.
 - Additional instructions, **mtsr** and **mtsrin**, are used for writing to the segment descriptors for systems that provide a full 80-bit virtual address space as defined for 64-bit MMUs.
 - Additional bit in the machine state register (MSR[ISF]) that is copied to the MSR[SF] bit to control whether the processor is in 32- or 64-bit mode when an exception is taken
 - The ability to implement the **rfi** and **mtmsr** instructions as defined for 32-bit implementations

In addition to these substantive changes, this book reflects smaller changes and clarifications to the PowerPC architecture. For more information, see Section 1.3, “Changes in This Revision of The Programming Environments Manual.”

U 1.2 The PowerPC Architectural Models

V This section provides overviews of aspects defined by the PowerPC architecture, following
O the same order as the rest of this book. The topics include the following:

- PowerPC registers and programming model
- PowerPC operand conventions
- PowerPC instruction set and addressing modes
- PowerPC cache model
- PowerPC exception model
- PowerPC memory management model

1.2.1 PowerPC Registers and Programming Model

The PowerPC architecture defines register-to-register operations for computational instructions. Source operands for these instructions are accessed from the architected registers or are provided as immediate values embedded in the instruction. The three-register instruction format allows specification of a target register distinct from two source operand registers. This scheme allows efficient code scheduling in a highly parallel processor. Load and store instructions are the only instructions that transfer data between registers and memory. The PowerPC registers are shown in Figure 1-1.

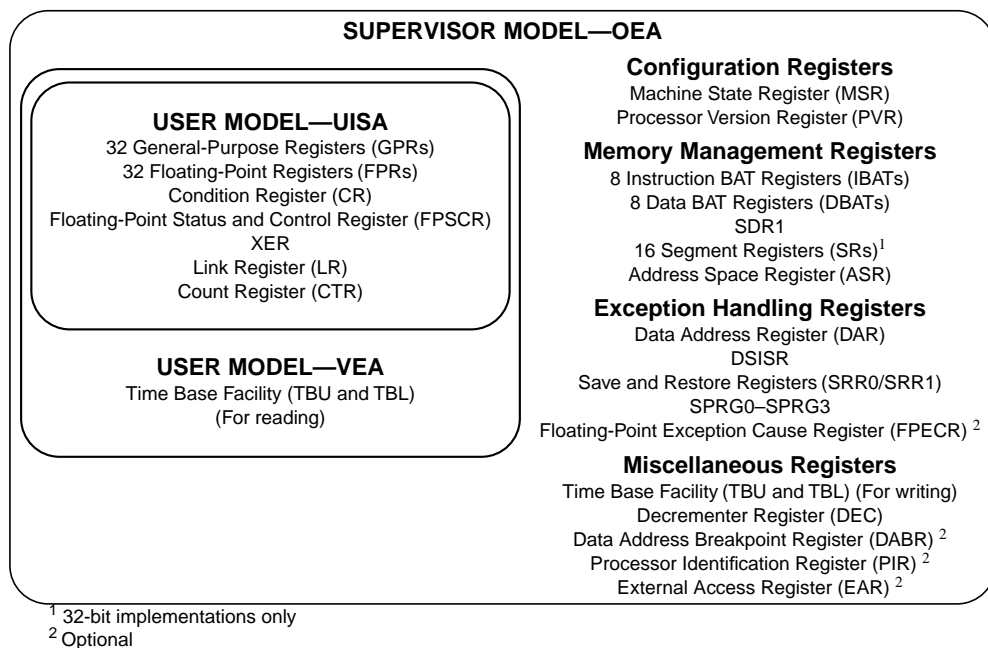

Figure 1-1. Programming Model—PowerPC Registers

The programming model incorporates 32 GPRs, 32 FPRs, special-purpose registers (SPRs), and several miscellaneous registers. Each implementation may have its own unique set of hardware implementation (HID) registers that are not defined by the architecture.

PowerPC processors have two levels of privilege:

- Supervisor mode—used exclusively by the operating system. Resources defined by the OEA can be accessed only supervisor-level software.
- User mode—used by the application software and operating system software (Only resources defined by the UISA and VEA can be accessed by user-level software)

These two levels govern the access to registers, as shown in Figure 1-1. The division of privilege allows the operating system to control the application environment (providing virtual memory and protecting operating system and critical machine resources). Instructions that control the state of the processor, the address translation mechanism, and supervisor registers can be executed only when the processor is operating in supervisor mode.

- **User Instruction Set Architecture Registers**—All UISA registers can be accessed by all software with either user or supervisor privileges. These registers include the 32 general-purpose registers (GPRs) and the 32 floating-point registers (FPRs), and other registers used for integer, floating-point, and branch instructions. U
- **Virtual Environment Architecture Registers**—The VEA defines the user-level portion of the time base facility, which consists of the two 32-bit time base registers. These registers can be read by user-level software, but can be written to only by supervisor-level software. V
- **Operating Environment Architecture Registers**—SPRs defined by the OEA are used for system-level operations such as memory management, exception handling, and time-keeping. O

The PowerPC architecture also provides room in the SPR space for implementation-specific registers, typically referred to as HID registers. Individual HIDs are not discussed in this manual.

1.2.2 Operand Conventions

Operand conventions are defined in two levels of the PowerPC architecture—user instruction set architecture (UISA) and virtual environment architecture (VEA). These conventions define how data is stored in registers and memory. U V

1.2.2.1 Byte Ordering

The default mapping for PowerPC processors is big-endian, but the UISA provides the option of operating in either big- or little-endian mode. Big-endian byte ordering is shown in Figure 1-2. U

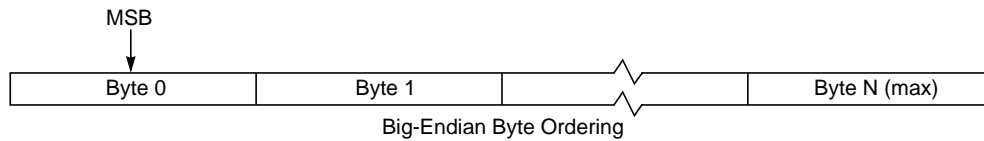

Figure 1-2. Big-Endian Byte and Bit Ordering

- The OEA defines two bits in the MSR for specifying byte ordering—LE (little-endian mode) and ILE (exception little-endian mode). The LE bit specifies whether the processor is configured for big-endian or little-endian mode; the ILE bit specifies the mode when an exception is taken by being copied into the LE bit of the MSR. A value of 0 specifies big-endian mode and a value of 1 specifies little-endian mode.

1.2.2.2 Data Organization in Memory and Data Transfers

Bytes in memory are numbered consecutively starting with 0. Each number is the address of the corresponding byte.

Memory operands may be bytes, half words, words, or double words, or, for the load/store string/multiple instructions, a sequence of bytes or words. The address of a multiple-byte memory operand is the address of its first byte (that is, of its lowest-numbered byte). Operand length is implicit for each instruction.

The operand of a single-register memory access instruction has a natural alignment boundary equal to the operand length. In other words, the natural address of an operand is an integral multiple of the operand length. A memory operand is said to be aligned if it is aligned at its natural boundary; otherwise it is misaligned.

1.2.2.3 Floating-Point Conventions

- ⊔ The PowerPC architecture adheres to the IEEE-754 standard for 64- and 32-bit floating-point arithmetic:
 - Double-precision arithmetic instructions may have single- or double-precision operands but always produce double-precision results.
 - Single-precision arithmetic instructions require all operands to be single-precision values and always produce single-precision results. Single-precision values are stored in double-precision format in the FPRs—these values are rounded such that they can be represented in 32-bit, single-precision format (as they are in memory).

1.2.3 PowerPC Instruction Set and Addressing Modes

All PowerPC instructions are encoded as single-word (32-bit) instructions. Instruction formats are consistent among all instruction types, permitting decoding to occur in parallel with operand accesses. This fixed instruction length and consistent format greatly simplifies instruction pipelining.

1.2.3.1 PowerPC Instruction Set

Although these categories are not defined by the PowerPC architecture, the PowerPC instructions can be grouped as follows:

- Integer instructions—These instructions are defined by the UISA. They include computational and logical instructions. U
 - Integer arithmetic instructions
 - Integer compare instructions
 - Logical instructions
 - Integer rotate and shift instructions
- Floating-point instructions—These instructions, defined by the UISA, include floating-point computational instructions, as well as instructions that manipulate the floating-point status and control register (FPSCR).
 - Floating-point arithmetic instructions
 - Floating-point multiply/add instructions
 - Floating-point compare instructions
 - Floating-point status and control instructions
 - Floating-point move instructions
 - Optional floating-point instructions
- Load/store instructions—These instructions, defined by the UISA, include integer and floating-point load and store instructions.
 - Integer load and store instructions
 - Integer load and store with byte reverse instructions
 - Integer load and store multiple instructions
 - Integer load and store string instructions
 - Floating-point load and store instructions
- The UISA also provides a set of load/store with reservation instructions (**lwarx/ldarx** and **stwx/stdcx.**) that can be used as primitives for constructing atomic memory operations. These are grouped under synchronization instructions.
- Synchronization instructions—The UISA and VEA define instructions for memory synchronizing, especially useful for multiprocessing:
 - Load and store with reservation instructions—These UISA-defined instructions provide primitives for synchronization operations such as test and set, compare and swap, and compare memory.
 - The Synchronize instruction (**sync**)—This UISA-defined instruction is useful for synchronizing load and store operations on a memory bus that is shared by multiple devices.
 - Enforce In-Order Execution of I/O (**eiio**)— The **eiio** instruction provides an ordering function for the effects of load and store operations executed by a processor. V

- Flow control instructions—These include branching instructions, condition register logical instructions, trap instructions, and other instructions that affect the instruction flow.
- U — The UISA defines numerous instructions that control the program flow, including branch, trap, and system call instructions as well as instructions that read, write, or manipulate bits in the condition register.
- O — The OEA defines two flow control instructions that provide system linkage. These instructions are used for entering and returning from supervisor level.
- Processor control instructions—These instructions are used for synchronizing memory accesses and managing caches and translation lookaside buffers (TLBs) (and segment registers in 32-bit implementations). These instructions include move to/from special-purpose register instructions (**mtspr** and **mfspir**).
- V • Memory/cache control instructions—These instructions provide control of caches, TLBs, and segment registers (in 32-bit implementations).
- O — The VEA defines several cache control instructions.
- The OEA defines one cache control instruction and several memory control instructions.
- V • External control instructions—The VEA defines two optional instructions for use with special input/output devices.

O

TEMPORARY 64-BIT BRIDGE

- The 64-bit bridge allows several instructions to be used in 64-bit implementations that are otherwise defined for use in 32-bit implementations only. These include the following:
 - Move to Segment Register (**mtsr**) and Move to Segment Register Indirect (**mtsrin**)
 - Move from Segment Register (**mfsrc**) and Move from Segment Register Indirect (**mfsrcin**)

All four of these instructions are implemented as a group and are never implemented individually. Attempting to execute one of these instructions on a 64-bit implementation on which these instructions are not supported causes program exception.
- The 64-bit bridge also defines two instructions, Move to Segment Register Double Word (**mtsrdd**) and Move to Segment Register Double Word Indexed (**mtsrddin**) that allow an operating system to write to segment descriptors to support accesses to 64-bit address space.
- Processors that implement the 64-bit bridge can optionally implement the **rft** and **mtmsr** instructions, which otherwise are not supported in the 64-bit architecture.

Note that this grouping of the instructions does not indicate which execution unit executes a particular instruction or group of instructions. This is not defined by the PowerPC architecture.

1.2.3.2 Calculating Effective Addresses

The effective address (EA), also called the logical address, is the address computed by the processor when executing a memory access or branch instruction or when fetching the next sequential instruction. Unless address translation is disabled, this address is converted by the MMU to the appropriate physical address. (Note that the architecture specification uses only the term effective address and not logical address.)

The PowerPC architecture supports the following simple addressing modes for memory access instructions:

- $EA = (rA|0)$ (register indirect)
- $EA = (rA|0) + \text{offset}$ (including offset = 0) (register indirect with immediate index)
- $EA = (rA|0) + rB$ (register indirect with index)

These simple addressing modes allow efficient address generation for memory accesses.

1.2.4 PowerPC Cache Model

The VEA and OEA portions of the architecture define aspects of cache implementations for PowerPC processors. The PowerPC architecture does not define hardware aspects of cache implementations. For example, some PowerPC processors may have separate instruction and data caches (Harvard architecture), while others have a unified cache.

The PowerPC architecture allows implementations to control the following memory access modes on a page or block basis:

- Write-back/write-through mode
- Caching-inhibited mode
- Memory coherency
- Guarded/not guarded against speculative accesses

Coherency is maintained on a cache block basis, and cache control instructions perform operations on a cache block basis. The size of the cache block is implementation-dependent. The term cache block should not be confused with the notion of a block in memory, which is described in Section 1.2.6, “PowerPC Memory Management Model.”

The VEA portion of the PowerPC architecture defines several instructions for cache management. These can be used by user-level software to perform such operations as touch operations (which cause the cache block to be speculatively loaded), and operations to store, flush, or clear the contents of a cache block. The OEA portion of the architecture defines one cache management instruction—the Data Cache Block Invalidate (**dcbi**) instruction.

1.2.5 PowerPC Exception Model

The PowerPC exception mechanism, defined by the OEA, allows the processor to change to supervisor state as a result of external signals, errors, or unusual conditions arising in the execution of instructions. When exceptions occur, information about the state of the processor is saved to various registers and the processor begins execution at an address (exception vector) predetermined for each type of exception. Exception handler routines begin execution in supervisor mode. The PowerPC exception model is described in detail in Chapter 6, “Exceptions.” Note also that some aspects regarding exception conditions are defined at other levels of the architecture. For example, floating-point exception conditions are defined by the UISA, whereas the exception mechanism is defined by the OEA.

PowerPC architecture requires that exceptions be handled in program order (excluding the optional floating-point imprecise modes and the reset and machine check exception); therefore, although a particular implementation may recognize exception conditions out of order, they are handled strictly in order. When an instruction-caused exception is recognized, any unexecuted instructions that appear earlier in the instruction stream, including any that have not yet begun to execute, are required to complete before the exception is taken. Any exceptions caused by those instructions must be handled first. Likewise, exceptions that are asynchronous and precise are recognized when they occur, but are not handled until all instructions currently executing successfully complete processing and report their results.

The OEA supports four types of exceptions:

- Synchronous, precise
- Synchronous, imprecise
- Asynchronous, maskable
- Asynchronous, nonmaskable

○ 1.2.6 PowerPC Memory Management Model

The PowerPC memory management unit (MMU) specifications are provided by the PowerPC OEA. The primary functions of the MMU in a PowerPC processor are to translate logical (effective) addresses to physical addresses for memory accesses and I/O accesses (most I/O accesses are assumed to be memory-mapped), and to provide access protection on a block or page basis. Note that many aspects of memory management are implementation-dependent. The description in Chapter 7, “Memory Management,” describes the conceptual model of a PowerPC MMU; however, PowerPC processors may differ in the specific hardware used to implement the MMU model of the OEA.

PowerPC processors require address translation for two types of transactions—instruction accesses and data accesses to memory (typically generated by load and store instructions).

The memory management specification of the PowerPC OEA includes models for both 64- and 32-bit implementations. The MMU of a 64-bit PowerPC processor provides 2^{64} bytes

of logical address space accessible to supervisor and user programs with a 4-Kbyte page size and 256-Mbyte segment size.

In 32-bit implementations, the entire 4-Gbyte memory space is defined by sixteen 256-Mbyte segments. Segments are configured through the 16 segment registers. In 64-bit implementations there are more segments than can be maintained in architecture-defined registers, so segment descriptors are maintained in segment table entries (STEs) in memory and are accessed through the use of a hashing algorithm much like that used for accessing page table entries (PTEs).

PowerPC processors also have a block address translation (BAT) mechanism for mapping large blocks of memory. Block sizes range from 128 Kbyte to 256 Mbyte and are software-selectable. In addition, the MMU of 64-bit PowerPC processors uses an interim virtual address (80 bits) and hashed page tables in the generation of 64-bit physical addresses.

Two types of accesses generated by PowerPC processors require address translation: instruction accesses, and data accesses to memory generated by load and store instructions. The address translation mechanism is defined in terms of segment tables (or segment registers in 32-bit implementations) and page tables used by PowerPC processors to locate the logical-to-physical address mapping for instruction and data accesses. The segment information translates the logical address to an interim virtual address, and the page table information translates the virtual address to a physical address.

Translation lookaside buffers (TLBs) are commonly implemented in PowerPC processors to keep recently-used page table entries on-chip. Although their exact characteristics are not specified by the architecture, the general concepts that are pertinent to the system software are described. Similarly, 64-bit implementations may contain segment lookaside buffers (SLBs) on-chip that contain recently-used segment table entries, but for which the PowerPC architecture does not define the exact characteristics.

The block address translation (BAT) mechanism is a software-controlled array that stores the available block address translations on-chip. BAT array entries are implemented as pairs of BAT registers that are accessible as supervisor special-purpose registers (SPRs); refer to Chapter 7, “Memory Management,” for more information.

TEMPORARY 64-BIT BRIDGE

The 64-bit bridge provides resources that may make it easier for a 32-bit operating system to migrate to a 64-bit processor. The nature of these resources are largely determined by the fact that in a 32-bit address space, only 16 segment descriptors are required to define all 4 Gbytes of memory. That is, there are sixteen 256-Mbyte segments, as is the case in the 32-bit architecture description.

1.3 Changes in This Revision of *The Programming Environments Manual*

This book reflects changes made to the PowerPC architecture after the publication of Rev. 0 of *The Programming Environments Manual* and before Dec. 13, 1994 (Rev. 0.1). In addition, it reflects changes made to the architecture after the publication of Rev. 0.1 of *The Programming Environments Manual* and before Aug. 6, 1996 (Rev. 1). Although there are many changes in this revision of *The Programming Environments Manual*, this section summarizes only the most significant changes and clarifications to the architecture specification. There are three types of substantive changes made from Rev. 0 to Rev. 1.

- The temporary addition of a set of resources for optional implementation in 64-bit processors to simplify the adaptation of 32-bit operating systems. These resources are described briefly in Section 1.3.1, “Changes Related to the Optional 64-Bit Bridge.”
- The phasing out of the direct-store facility. This facility defined segments that were used to generate direct-store interface accesses on the external bus to communicate with specialized I/O devices; it was not optimized for performance in the PowerPC architecture and was present for compatibility with older devices only. As of this revision of the architecture (Rev. 1), direct-store segments are an optional processor feature. However, they are not likely to be supported in future implementations and new software should not use them.
- General additions to and refinements of the architecture specification are summarized in Section 1.3.2, “General Changes to the PowerPC Architecture.”

TEMPORARY 64-BIT BRIDGE

1.3.1 Changes Related to the Optional 64-Bit Bridge

As of Rev. 0.1 of the architecture specification, the OEA now provides optional features that facilitate the migration of operating systems from 32-bit processor designs to 64-bit processors. These features, which can be implemented in part or in whole, include the following:

Table 1-1. Optional 64-Bit Bridge Features

Change	Chapter(s) Affected
ASR[V] (bit 63) may be implemented to indicate whether ASR[STABORG] holds a valid physical base address for the segment table.	2, 7
Support for four 32-bit instructions that are otherwise defined as illegal in 64-bit mode. These include the following— mtsr , mtsrin , mfsr , mfsrin . These instructions can be implemented only if ASR[V] is implemented.	4, 7, 8
Additional instructions, mtsr d and mtsr din, that allow software to associate effective segments 0–15 with any of virtual segments 0–(2 ⁵² – 1) without affecting the segment table. These instructions move 64 bits from a specified GPR to a selected SLB entry. These instructions can be implemented only if ASR[V] is implemented.	4, 7, 8
The rfi and mtmsr instructions, which are otherwise illegal in the 64-bit architecture, may optionally be implemented in 64-bit processors if ASR[V] is implemented.	4, 6, 7, 8
MSR[ISF] (bit 2) is defined as an optional bit that can be used to control the mode (64-bit or 32-bit) that is entered when an exception is taken. If the bit is not implemented, it is treated as reserved, except that it is assumed to be set for exception processing.	2, 6, 7

To determine whether a processor implements any or all of the bridge features, consult the user's manual for that processor.

1.3.2 General Changes to the PowerPC Architecture

Table 1-2 and Table 1-3 list changes made to the UISA that are reflected in this book and identify the chapters affected by those changes. Note that many of the changes made in the UISA are reflected in both the VEA and OEA portions of the architecture as well.

Table 1-2. UISA Changes—Rev. 0 to Rev. 0.1

Change	Chapter(s) Affected
The rules for handling of reserved bits in registers are clarified.	2
Clarified that isync does not wait for memory accesses to be performed.	4, 8
CR0[0–2] are undefined for some instructions in 64-bit mode.	4, 8

Table 1-2. UISA Changes—Rev. 0 to Rev. 0.1 (Continued)

Change	Chapter(s) Affected
Clarified intermediate result with respect to floating-point operations (the intermediate result has infinite precision and unbounded exponent range).	3
Clarified the definition of rounding such that rounding always occurs (specifically, FR and FI flags are always affected) for arithmetic, rounding, and conversion instructions.	3
Clarified the definition of the term 'tiny' (detected before rounding).	3
In D.3.5, "Conversion from Floating-Point Number to Unsigned Fixed-Point Integer Word," changed value in FPR 3 from 2^{32} to $2^{32} - 1$ (in 32-bit implementation description).	D
Noted additional POWER incompatibility for Store Floating-Point Single (stfs) instruction.	B

Table 1-3. UISA Changes—Rev. 0.1 to Rev. 1.0

Change	Chapter(s) Affected
Although the stfiwx instruction is an optional instruction, it will likely be required for future processors.	4, 8, A
Added the new Data Cache Block Allocate (dcba) instruction.	4, 5, 8, A
Deleted some warnings about generating misaligned little-endian access.	3

Table 1-4 and Table 1-5 list changes made to the VEA that are reflected in this book and the chapters that are affected by those changes. Note that some changes to the UISA are reflected in the VEA and in turn, some changes to the VEA affect the OEA as well.

Table 1-4. VEA Changes—Rev. 0 to Rev. 0.1

Change	Chapter(s) Affected
Clarified conditions under which a cache block is considered modified.	5
WIMG bits have meaning only when the effective address is translated.	2, 5, 7
Clarified that isync does not wait for memory accesses to be performed.	4, 5, 7, 8
Clarified paging implications of eciwx and ecowx .	4, 5, 7, 8

Table 1-5. VEA Changes—Rev. 0.1 to Rev. 1.0

Change	Chapter(s) Affected
Added the requirement that caching-inhibited guarded store operations are ordered.	5
Clarified use of the dcbf instruction in keeping instruction cache coherency in the case of a combined instruction/data cache in a multiprocessor system.	5

Table 1-6 and Table 1-7 list changes made to the OEA that are reflected in this book and the chapters that are affected by those changes. Note that some changes to the UISA and VEA are reflected in the OEA as well.

Table 1-6. OEA Changes—Rev. 0 to Rev. 0.1

Change	Chapter(s) Affected
Restricted several aspects of out-of-order operations.	2, 4, 5, 6, 7
Clarified instruction fetching and instruction cache paradoxes.	4, 5
Specified that IBATs contain W and G bits and that software must not write 1s to them.	2, 7
Corrected the description of coherence when the W bit differs among processors.	5
Clarified that referenced and changed bits are set for virtual pages.	7
Revised the description of changed bit setting to avoid depending on the TLB.	7
Tightened the rules for setting the changed bit out of order.	5, 7
Specified which multiple DSISR bits may be set due to simultaneous DSI exceptions.	6
Removed software synchronization requirements for reading the TB and DEC.	2
More flexible DAR setting for a DABR exception.	6

Table 1-7. OEA Changes—Rev. 0.1 to Rev. 1.0

Change	Chapter(s) Affected
Changed definition of direct-store segments to an optional processor feature that is not likely to be supported in future implementations and new software should not use it.	2, 6, 7
Changed the ranges of bits saved from MSR to SRR1 (and restored from SRR1 to MSR on rfi(d)) on an exception.	2, 6
Clarified the definition of execution synchronization. Also clarified that the mtmsr and mtmsrd instructions are not execution synchronizing.	2, 4, 8
Clarified the use of memory allocated for predefined uses (including the exception vectors).	6, 7
For 64-bit implementations, changed the definition of the base address for the exception vectors when MSR[IP] = 1 from FFFF_FFFF to 0000-0000.	6
For 64-bit implementations, added the provision for virtual address spaces of 64 bits (as an alternative to the existing 80 bits).	7
Revised the page table update synchronization requirements and recommended code sequences.	7

Chapter 2

PowerPC Register Set

This chapter describes the register organization defined by the three levels of the PowerPC architecture—user instruction set architecture (UISA), virtual environment architecture (VEA), and operating environment architecture (OEA). The PowerPC architecture defines register-to-register operations for all computational instructions. Source data for these instructions are accessed from the on-chip registers or are provided as immediate values embedded in the opcode. The three-register instruction format allows specification of a target register distinct from the two source registers, thus preserving the original data for use by other instructions and reducing the number of instructions required for certain operations. Data is transferred between memory and registers with explicit load and store instructions only.

Note that the handling of reserved bits in any register is implementation-dependent. Software is permitted to write any value to a reserved bit in a register. However, a subsequent reading of the reserved bit returns 0 if the value last written to the bit was 0 and returns an undefined value (may be 0 or 1) otherwise. This means that even if the last value written to a reserved bit was 1, reading that bit may return 0.

2.1 PowerPC UISA Register Set

The PowerPC UISA registers, shown in Figure 2-1, can be accessed by either user- or supervisor-level instructions (the architecture specification refers to user-level and supervisor-level as problem state and privileged state respectively). The general-purpose registers (GPRs) and floating-point registers (FPRs) are accessed as instruction operands. Access to registers can be explicit (that is, through the use of specific instructions for that purpose such as Move to Special-Purpose Register (**mtspr**) and Move from Special-Purpose Register (**mfspr**) instructions) or implicit as part of the execution of an instruction. Some registers are accessed both explicitly and implicitly.

The number to the right of the register names indicates the number that is used in the syntax of the instruction operands to access the register (for example, the number used to access the XER is SPR 1).

Note that the general-purpose registers (GPRs), link register (LR), and count register (CTR) are 64 bits wide on 64-bit implementations and 32 bits wide on 32-bit implementations.

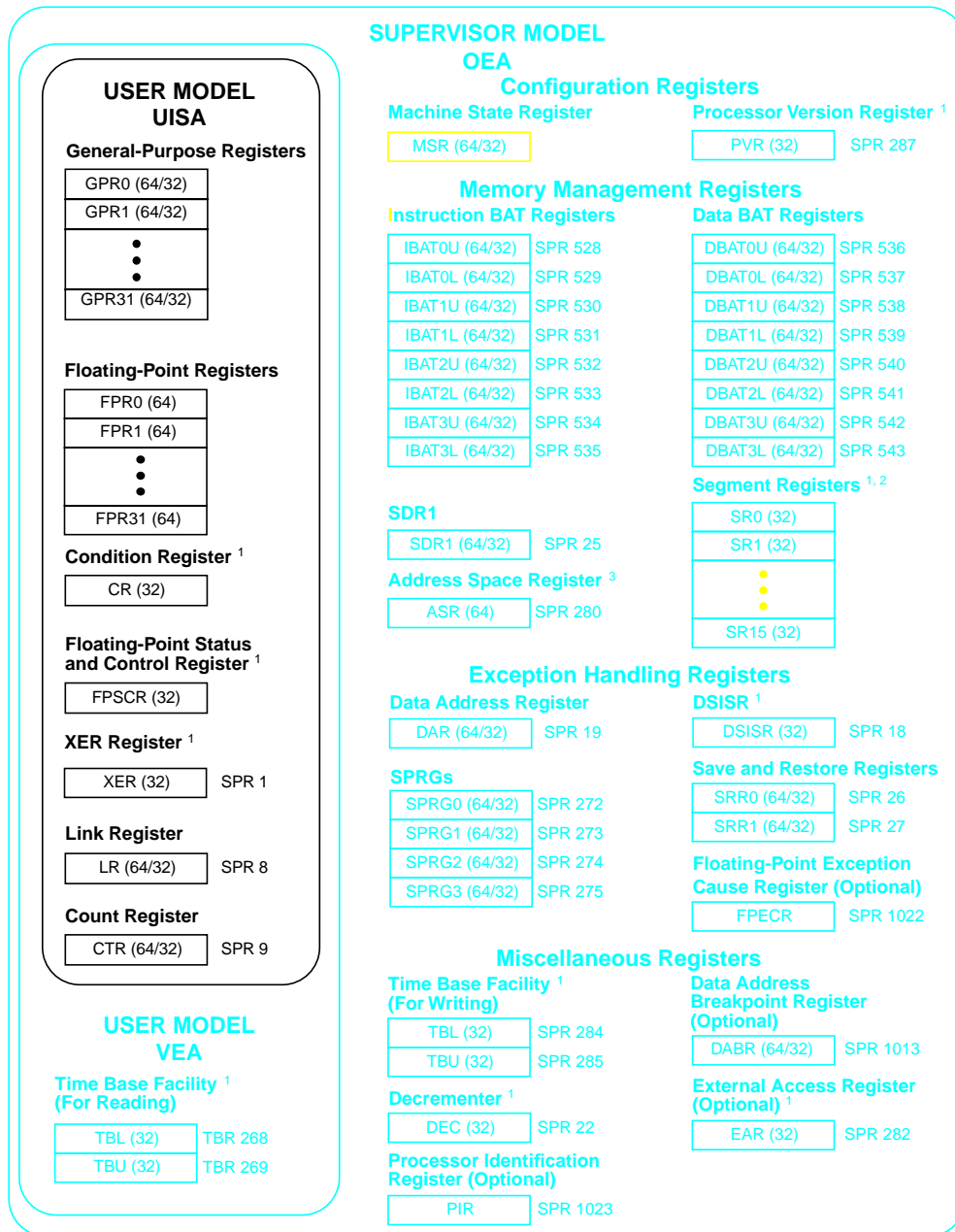

¹ These registers are 32-bit registers only.
² These registers are on 32-bit implementations only.
³ These registers are on 64-bit implementations only.

Figure 2-1. UISA Programming Model—User-Level Registers

The user-level registers can be accessed by all software with either user or supervisor privileges. The user-level register set includes the following:

- General-purpose registers (GPRs). The general-purpose register file consists of 32 GPRs designated as GPR0–GPR31. The GPRs serve as data source or destination registers for all integer instructions and provide data for generating addresses. See Section 2.1.1, “General-Purpose Registers (GPRs),” for more information.
- Floating-point registers (FPRs). The floating-point register file consists of 32 FPRs designated as FPR0–FPR31; these registers serve as the data source or destination for all floating-point instructions. While the floating-point model includes data objects of either single- or double-precision floating-point format, the FPRs only contain data in double-precision format. For more information, see Section 2.1.2, “Floating-Point Registers (FPRs).”
- Condition register (CR). The CR is a 32-bit register, divided into eight 4-bit fields, CR0–CR7, that reflects the results of certain arithmetic operations and provides a mechanism for testing and branching. For more information, see Section 2.1.3, “Condition Register (CR).”
- Floating-point status and control register (FPSCR). The FPSCR contains all floating-point exception signal bits, exception summary bits, exception enable bits, and rounding control bits needed for compliance with the IEEE 754 standard. For more information, see Section 2.1.4, “Floating-Point Status and Control Register (FPSCR).” (Note that the architecture specification refers to exceptions as interrupts.)
- XER register (XER). The XER indicates overflows and carry conditions for integer operations and the number of bytes to be transferred by the load/store string indexed instructions. For more information, see Section 2.1.5, “XER Register (XER).”
- Link register (LR). The LR provides the branch target address for the Branch Conditional to Link Register (**bclrx**) instructions, and can optionally be used to hold the effective address of the instruction that follows a branch with link update instruction in the instruction stream, typically used for loading the return pointer for a subroutine. For more information, see Section 2.1.6, “Link Register (LR).”
- Count register (CTR). The CTR holds a loop count that can be decremented during execution of appropriately coded branch instructions. The CTR can also provide the branch target address for the Branch Conditional to Count Register (**bcctrx**) instructions. For more information, see Section 2.1.7, “Count Register (CTR).”

2.1.1 General-Purpose Registers (GPRs)

Integer data is manipulated in the processor’s 32 GPRs shown in Figure 2-2. These registers are 64-bit registers in 64-bit implementations and 32-bit registers in 32-bit implementations. The GPRs are accessed as source and destination registers in the instruction syntax.

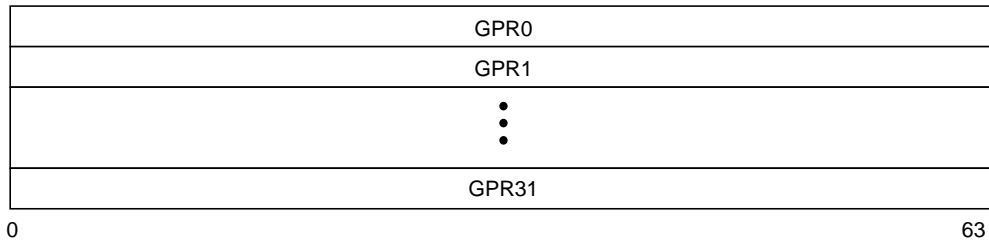

Figure 2-2. General-Purpose Registers (GPRs)

2.1.2 Floating-Point Registers (FPRs)

The PowerPC architecture provides thirty-two 64-bit FPRs as shown in Figure 2-3. These registers are accessed as source and destination registers for floating-point instructions. Each FPR supports the double-precision floating-point format. Every instruction that interprets the contents of an FPR as a floating-point value uses the double-precision floating-point format for this interpretation. Note that FPRs are 64 bits on both 64-bit and 32-bit processor implementations.

All floating-point arithmetic instructions operate on data located in FPRs and, with the exception of compare instructions, place the result into an FPR. Information about the status of floating-point operations is placed into the FPSCR and in some cases, into the CR after the completion of instruction execution. For information on how the CR is affected for floating-point operations, see Section 2.1.3, “Condition Register (CR).”

Load and store double-word instructions transfer 64 bits of data between memory and the FPRs with no conversion. Load single instructions are provided to read a single-precision floating-point value from memory, convert it to double-precision floating-point format, and place it in the target floating-point register. Store single-precision instructions are provided to read a double-precision floating-point value from a floating-point register, convert it to single-precision floating-point format, and place it in the target memory location.

Single- and double-precision arithmetic instructions accept values from the FPRs in double-precision format. For single-precision arithmetic and store instructions, all input values must be representable in single-precision format; otherwise, the result placed into the target FPR (or the memory location) and the setting of status bits in the FPSCR and in the condition register (if the instruction’s record bit, Rc, is set) are undefined.

The floating-point arithmetic instructions produce intermediate results that may be regarded as infinitely precise and with unbounded exponent range. This intermediate result is normalized or denormalized if required, and then rounded to the destination format. The final result is then placed into the target FPR in the double-precision format or in fixed-point format, depending on the instruction. Refer to Section 3.3, “Floating-Point Execution Models—UIA,” for more information.

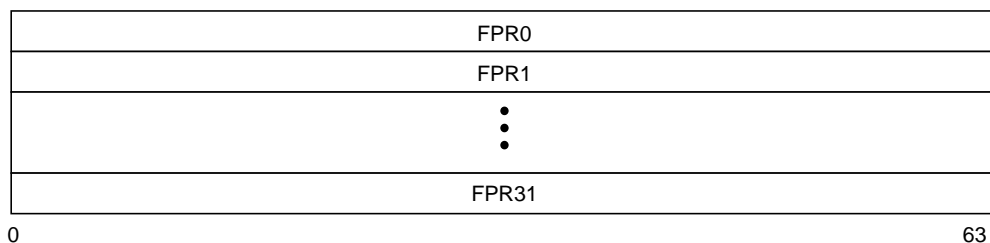

Figure 2-3. Floating-Point Registers (FPRs)

2.1.3 Condition Register (CR)

The condition register (CR) is a 32-bit register that reflects the result of certain operations and provides a mechanism for testing and branching. The bits in the CR are grouped into eight 4-bit fields, CR0–CR7, as shown in Figure 2-4.



Figure 2-4. Condition Register (CR)

The CR fields can be set in one of the following ways:

- Specified fields of the CR can be set from a GPR by using the **mcrf** instruction.
- The contents of XER[0–3] can be moved to another CR field by using the **mcrf** instruction.
- A specified field of the XER can be copied to a specified field of the CR by using the **mcrxr** instruction.
- A specified field of the FPSCR can be copied to a specified field of the CR by using the **mcrfs** instruction.
- Condition register logical instructions can be used to perform logical operations on specified bits in the condition register.
- CR0 can be the implicit result of an integer instruction.
- CR1 can be the implicit result of a floating-point instruction.
- A specified CR field can indicate the result of either an integer or floating-point compare instruction.

Note that branch instructions are provided to test individual CR bits.

2.1.3.1 Condition Register CR0 Field Definition

For all integer instructions, when the CR is set to reflect the result of the operation (that is, when $R_c = 1$), and for **addic.**, **andi.**, and **andis.**, the first three bits of CR0 are set by an algebraic comparison of the result to zero; the fourth bit of CR0 is copied from XER[SO]. For integer instructions, CR bits 0–3 are set to reflect the result as a signed quantity.

The CR bits are interpreted as shown in Table 2-1. If any portion of the result is undefined, the value placed into the first three bits of CR0 is undefined.

Table 2-1. Bit Settings for CR0 Field of CR

CR0 Bit	Description
0	Negative (LT)—This bit is set when the result is negative.
1	Positive (GT)—This bit is set when the result is positive (and not zero).
2	Zero (EQ)—This bit is set when the result is zero.
3	Summary overflow (SO)—This is a copy of the final state of XER[SO] at the completion of the instruction.

Note that CR0 may not reflect the true (that is, infinitely precise) result if overflow occurs. Also, CR0 bits 0–2 are undefined if $R_c = 1$ for the **mulhw**, **mulhwu**, **divw**, and **divwu** instructions in 64-bit mode.

2.1.3.2 Condition Register CR1 Field Definition

In all floating-point instructions when the CR is set to reflect the result of the operation (that is, when the instruction's record bit, R_c , is set), CR1 (bits 4–7 of the CR) is copied from bits 0–3 of the FPSCR and indicates the floating-point exception status. For more information about the FPSCR, see Section 2.1.4, "Floating-Point Status and Control Register (FPSCR)." The bit settings for the CR1 field are shown in Table 2-2.

Table 2-2. Bit Settings for CR1 Field of CR

CR1 Bit	Description
4	Floating-point exception (FX)—This is a copy of the final state of FPSCR[FX] at the completion of the instruction.
5	Floating-point enabled exception (FEX)—This is a copy of the final state of FPSCR[FEX] at the completion of the instruction.
6	Floating-point invalid exception (VX)—This is a copy of the final state of FPSCR[VX] at the completion of the instruction.
7	Floating-point overflow exception (OX)—This is a copy of the final state of FPSCR[OX] at the completion of the instruction.

2.1.3.3 Condition Register CR_n Field—Compare Instruction

For a compare instruction, when a specified CR field is set to reflect the result of the comparison, the bits of the specified field are interpreted as shown in Table 2-3.

Table 2-3. CR_n Field Bit Settings for Compare Instructions

CR _n Bit ¹	Description ²
0	Less than or floating-point less than (LT, FL). For integer compare instructions: rA < SIMM or rB (signed comparison) or rA < UIMM or rB (unsigned comparison). For floating-point compare instructions: frA < frB.
1	Greater than or floating-point greater than (GT, FG). For integer compare instructions: rA > SIMM or rB (signed comparison) or rA > UIMM or rB (unsigned comparison). For floating-point compare instructions: frA > frB.
2	Equal or floating-point equal (EQ, FE). For integer compare instructions: rA = SIMM, UIMM, or rB. For floating-point compare instructions: frA = frB.
3	Summary overflow or floating-point unordered (SO, FU). For integer compare instructions: This is a copy of the final state of XER[SO] at the completion of the instruction. For floating-point compare instructions: One or both of frA and frB is a Not a Number (NaN).

Notes:¹Here, the bit indicates the bit number in any one of the 4-bit subfields, CR0–CR7.

²For a complete description of instruction syntax conventions, refer to Table 8-2 on page 8-2.

2.1.4 Floating-Point Status and Control Register (FPSCR)

The FPSCR, shown in Figure 2-5, contains bits that do the following:

- Record exceptions generated by floating-point operations
- Record the type of the result produced by a floating-point operation
- Control the rounding mode used by floating-point operations
- Enable or disable the reporting of exceptions (invoking the exception handler)

Bits 0–23 are status bits. Bits 24–31 are control bits. Status bits in the FPSCR are updated at the completion of the instruction execution.

Except for the floating-point enabled exception summary (FEX) and floating-point invalid operation exception summary (VX), the exception condition bits in the FPSCR (bits 0–12 and 21–23) are sticky. Once set, sticky bits remain set until they are cleared by an **mcrfs**, **mtfsfi**, **mtfsf**, or **mtfsb0** instruction.

FEX and VX are the logical ORs of other FPSCR bits. Therefore, these two bits are not listed among the FPSCR bits directly affected by the various instructions.

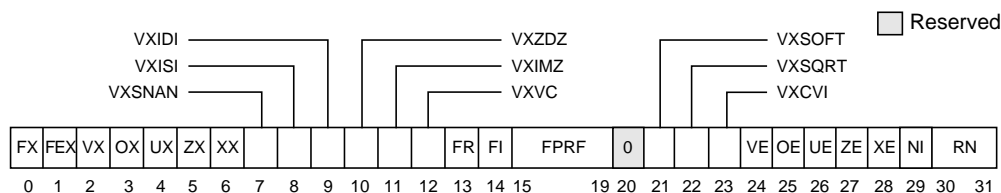

Figure 2-5. Floating-Point Status and Control Register (FPSCR)

A listing of FPSCR bit settings is shown in Table 2-4.

Table 2-4. FPSCR Bit Settings

Bit(s)	Name	Description
0	FX	Floating-point exception summary. Every floating-point instruction, except mtfsfi and mtfsf , implicitly sets FPSCR[FX] if that instruction causes any of the floating-point exception bits in the FPSCR to transition from 0 to 1. The mcrfs , mtfsfi , mtfsf , mtfsb0 , and mtfsb1 instructions can alter FPSCR[FX] explicitly. This is a sticky bit.
1	FEX	Floating-point enabled exception summary. This bit signals the occurrence of any of the enabled exception conditions. It is the logical OR of all the floating-point exception bits masked by their respective enable bits ($FEX = (VX \& VE) \wedge (OX \& OE) \wedge (UX \& UE) \wedge (ZX \& ZE) \wedge (XX \& XE)$). The mcrfs , mtfsf , mtfsfi , mtfsb0 , and mtfsb1 instructions cannot alter FPSCR[FEX] explicitly. This is not a sticky bit.
2	VX	Floating-point invalid operation exception summary. This bit signals the occurrence of any invalid operation exception. It is the logical OR of all of the invalid operation exceptions. The mcrfs , mtfsf , mtfsfi , mtfsb0 , and mtfsb1 instructions cannot alter FPSCR[VX] explicitly. This is not a sticky bit.
3	OX	Floating-point overflow exception. This is a sticky bit. See Section 3.3.6.2, "Overflow, Underflow, and Inexact Exception Conditions."
4	UX	Floating-point underflow exception. This is a sticky bit. See Section 3.3.6.2.2, "Underflow Exception Condition."
5	ZX	Floating-point zero divide exception. This is a sticky bit. See Section 3.3.6.1.2, "Zero Divide Exception Condition."
6	XX	Floating-point inexact exception. This is a sticky bit. See Section 3.3.6.2.3, "Inexact Exception Condition." FPSCR[XX] is the sticky version of FPSCR[FI]. The following rules describe how FPSCR[XX] is set by a given instruction: <ul style="list-style-type: none"> • If the instruction affects FPSCR[FI], the new value of FPSCR[XX] is obtained by logically ORing the old value of FPSCR[XX] with the new value of FPSCR[FI]. • If the instruction does not affect FPSCR[FI], the value of FPSCR[XX] is unchanged.
7	VXSNAN	Floating-point invalid operation exception for SNaN. This is a sticky bit. See Section 3.3.6.1.1, "Invalid Operation Exception Condition."
8	VXISI	Floating-point invalid operation exception for $\infty - \infty$. This is a sticky bit. See Section 3.3.6.1.1, "Invalid Operation Exception Condition."
9	VXIDI	Floating-point invalid operation exception for $\infty + \infty$. This is a sticky bit. See Section 3.3.6.1.1, "Invalid Operation Exception Condition."
10	VXZDZ	Floating-point invalid operation exception for $0 \div 0$. This is a sticky bit. See Section 3.3.6.1.1, "Invalid Operation Exception Condition."

Table 2-4. FPSCR Bit Settings (Continued)

Bit(s)	Name	Description
11	VXIMZ	Floating-point invalid operation exception for $\infty * 0$. This is a sticky bit. See Section 3.3.6.1.1, "Invalid Operation Exception Condition."
12	VXVC	Floating-point invalid operation exception for invalid compare. This is a sticky bit. See Section 3.3.6.1.1, "Invalid Operation Exception Condition."
13	FR	Floating-point fraction rounded. The last arithmetic or rounding and conversion instruction that rounded the intermediate result incremented the fraction. See Section 3.3.5, "Rounding." This bit is not sticky.
14	FI	Floating-point fraction inexact. The last arithmetic or rounding and conversion instruction either rounded the intermediate result (producing an inexact fraction) or caused a disabled overflow exception. See Section 3.3.5, "Rounding." This is not a sticky bit. For more information regarding the relationship between FPSCR[FI] and FPSCR[XX], see the description of the FPSCR[XX] bit.
15–19	FPRF	Floating-point result flags. For arithmetic, rounding, and conversion instructions, the field is based on the result placed into the target register, except that if any portion of the result is undefined, the value placed here is undefined. 15 Floating-point result class descriptor (C). Arithmetic, rounding, and conversion instructions may set this bit with the FPCC bits to indicate the class of the result as shown in Table 2-5. 16–19 Floating-point condition code (FPCC). Floating-point compare instructions always set one of the FPCC bits to one and the other three FPCC bits to zero. Arithmetic, rounding, and conversion instructions may set the FPCC bits with the C bit to indicate the class of the result. Note that in this case the high-order three bits of the FPCC retain their relational significance indicating that the value is less than, greater than, or equal to zero. 16 Floating-point less than or negative (FL or <) 17 Floating-point greater than or positive (FG or >) 18 Floating-point equal or zero (FE or =) 19 Floating-point unordered or NaN (FU or ?) Note that these are not sticky bits.
20	—	Reserved
21	VXSOFT	Floating-point invalid operation exception for software request. This is a sticky bit. This bit can be altered only by the mcrfs , mtfsfi , mtfsf , mtfsb0 , or mtfsb1 instructions. For more detailed information, refer to Section 3.3.6.1.1, "Invalid Operation Exception Condition."
22	VXSQRT	Floating-point invalid operation exception for invalid square root. This is a sticky bit. For more detailed information, refer to Section 3.3.6.1.1, "Invalid Operation Exception Condition."
23	VXCVI	Floating-point invalid operation exception for invalid integer convert. This is a sticky bit. See Section 3.3.6.1.1, "Invalid Operation Exception Condition."
24	VE	Floating-point invalid operation exception enable. See Section 3.3.6.1.1, "Invalid Operation Exception Condition."
25	OE	IEEE floating-point overflow exception enable. See Section 3.3.6.2, "Overflow, Underflow, and Inexact Exception Conditions."
26	UE	IEEE floating-point underflow exception enable. See Section 3.3.6.2.2, "Underflow Exception Condition."
27	ZE	IEEE floating-point zero divide exception enable. See Section 3.3.6.1.2, "Zero Divide Exception Condition."
28	XE	Floating-point inexact exception enable. See Section 3.3.6.2.3, "Inexact Exception Condition."

Table 2-4. FPSCR Bit Settings (Continued)

Bit(s)	Name	Description
29	NI	Floating-point non-IEEE mode. If this bit is set, results need not conform with IEEE standards and the other FPSCR bits may have meanings other than those described here. If the bit is set and if all implementation-specific requirements are met and if an IEEE-conforming result of a floating-point operation would be a denormalized number, the result produced is zero (retaining the sign of the denormalized number). Any other effects associated with setting this bit are described in the user's manual for the implementation (the effects are implementation-dependent).
30–31	RN	Floating-point rounding control. See Section 3.3.5, "Rounding." 00 Round to nearest 01 Round toward zero 10 Round toward +infinity 11 Round toward –infinity

Table 2-5 illustrates the floating-point result flags used by PowerPC processors. The result flags correspond to FPSCR bits 15–19.

Table 2-5. Floating-Point Result Flags in FPSCR

Result Flags (Bits 15–19)					Result Value Class
C	<	>	=	?	
1	0	0	0	1	Quiet NaN
0	1	0	0	1	–Infinity
0	1	0	0	0	–Normalized number
1	1	0	0	0	–Denormalized number
1	0	0	1	0	–Zero
0	0	0	1	0	+Zero
1	0	1	0	0	+Denormalized number
0	0	1	0	0	+Normalized number
0	0	1	0	1	+Infinity

2.1.5 XER Register (XER)

The XER register (XER) is a 32-bit, user-level register shown in Figure 2-6.

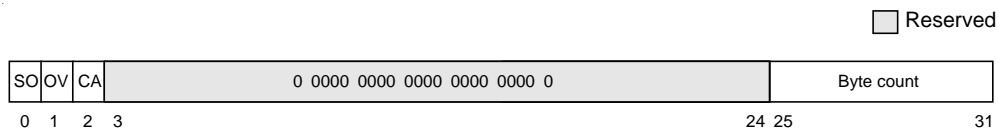

Figure 2-6. XER Register

The bit definitions for XER, shown in Table 2-6, are based on the operation of an instruction considered as a whole, not on intermediate results. For example, the result of the Subtract from Carrying (**subfcx**) instruction is specified as the sum of three values. This instruction sets bits in the XER based on the entire operation, not on an intermediate sum.

Table 2-6. XER Bit Definitions

Bit(s)	Name	Description
0	SO	Summary overflow. The summary overflow bit (SO) is set whenever an instruction (except mtspr) sets the overflow bit (OV). Once set, the SO bit remains set until it is cleared by an mtspr instruction (specifying the XER) or an mcrxr instruction. It is not altered by compare instructions, nor by other instructions (except mtspr to the XER, and mcrxr) that cannot overflow. Executing an mtspr instruction to the XER, supplying the values zero for SO and one for OV, causes SO to be cleared and OV to be set.
1	OV	Overflow. The overflow bit (OV) is set to indicate that an overflow has occurred during execution of an instruction. Add, subtract from, and negate instructions having OE = 1 set the OV bit if the carry out of the msb is not equal to the carry out of the msb + 1, and clear it otherwise. Multiply low and divide instructions having OE = 1 set the OV bit if the result cannot be represented in 64 bits (mulld , divd , divdu) or in 32 bits (mullw , divw , divwu), and clear it otherwise. The OV bit is not altered by compare instructions that cannot overflow (except mtspr to the XER, and mcrxr).
2	CA	Carry. The carry bit (CA) is set during execution of the following instructions: <ul style="list-style-type: none"> • Add carrying, subtract from carrying, add extended, and subtract from extended instructions set CA if there is a carry out of the msb, and clear it otherwise. • Shift right algebraic instructions set CA if any 1 bits have been shifted out of a negative operand, and clear it otherwise. The CA bit is not altered by compare instructions, nor by other instructions that cannot carry (except shift right algebraic, mtspr to the XER, and mcrxr).
3–24	—	Reserved
25–31	—	This field specifies the number of bytes to be transferred by a Load String Word Indexed (lswx) or Store String Word Indexed (stswx) instruction.

2.1.6 Link Register (LR)

The link register (LR) is a 64-bit register in 64-bit implementations and a 32-bit register in 32-bit implementations. The LR supplies the branch target address for the Branch Conditional to Link Register (**bclrx**) instructions, and in the case of a branch with link update instruction, can be used to hold the logical address of the instruction that follows the

branch with link update instruction (for returning from a subroutine). The format of LR is shown in Figure 2-7.

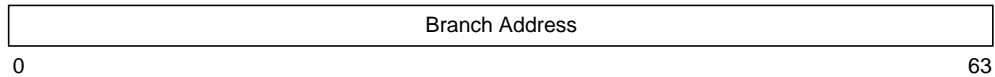

Figure 2-7. Link Register (LR)

Note that although the two least-significant bits can accept any values written to them, they are ignored when the LR is used as an address. Both conditional and unconditional branch instructions include the option of placing the logical address of the instruction following the branch instruction in the LR.

The link register can be also accessed by the **mtspr** and **mfspr** instructions using SPR 8. Prefetching instructions along the target path (loaded by an **mtspr** instruction) is possible provided the link register is loaded sufficiently ahead of the branch instruction (so that any branch prediction hardware can calculate the branch address). Additionally, PowerPC processors can prefetch along a target path loaded by a branch and link instruction.

Note that some PowerPC processors may keep a stack of the LR values most recently set by branch with link update instructions. To benefit from these enhancements, use of the link register should be restricted to the manner described in Section 4.2.4.2, “Conditional Branch Control.”

2.1.7 Count Register (CTR)

The count register (CTR) is a 64-bit register in 64-bit implementations and a 32-bit register in 32-bit implementations. The CTR can hold a loop count that can be decremented during execution of branch instructions that contain an appropriately coded BO field. If the value in CTR is 0 before being decremented, it is 0xFFFF_FFFF_FFFF_FFFF ($2^{64}-1$) afterward in 64-bit implementations and 0xFFFF_FFFF ($2^{32}-1$) in 32-bit implementations. The CTR can also provide the branch target address for the Branch Conditional to Count Register (**bctr_x**) instruction. The CTR is shown in Figure 2-8.



Figure 2-8. Count Register (CTR)

Prefetching instructions along the target path is also possible provided the count register is loaded sufficiently ahead of the branch instruction (so that any branch prediction hardware can calculate the correct value of the loop count).

The count register can also be accessed by the **mtspr** and **mfspr** instructions by specifying SPR 9. In branch conditional instructions, the BO field specifies the conditions under which

the branch is taken. The first four bits of the BO field specify how the branch is affected by or affects the CR and the CTR. The encoding for the BO field is shown in Table 2-7.

Table 2-7. BO Operand Encodings

BO	Description
0000y	Decrement the CTR, then branch if the decremented CTR \neq 0 and the condition is FALSE.
0001y	Decrement the CTR, then branch if the decremented CTR = 0 and the condition is FALSE.
001zy	Branch if the condition is FALSE.
0100y	Decrement the CTR, then branch if the decremented CTR \neq 0 and the condition is TRUE.
0101y	Decrement the CTR, then branch if the decremented CTR = 0 and the condition is TRUE.
011zy	Branch if the condition is TRUE.
1z00y	Decrement the CTR, then branch if the decremented CTR \neq 0.
1z01y	Decrement the CTR, then branch if the decremented CTR = 0.
1z1zz	Branch always.

Notes: The y bit provides a hint about whether a conditional branch is likely to be taken and is used by some PowerPC implementations to improve performance. Other implementations may ignore the y bit.

The z indicates a bit that is ignored. The z bits should be cleared (zero), as they may be assigned a meaning in a future version of the PowerPC UISA.

2.2 PowerPC VEA Register Set—Time Base

The PowerPC virtual environment architecture (VEA) defines registers in addition to those defined by the UISA. The PowerPC VEA register set can be accessed by all software with either user- or supervisor-level privileges. Figure 2-9 provides a graphic illustration of the PowerPC VEA register set. Note that the following programming model is similar to that found in Figure 2-1, however, the PowerPC VEA registers are now included.

The PowerPC VEA introduces the time base facility (TB), a 64-bit structure that consists of two 32-bit registers—time base upper (TBU) and time base lower (TBL). Note that the time base registers can be accessed by both user- and supervisor-level instructions. In the context of the VEA, user-level applications are permitted read-only access to the TB. The OEA defines supervisor-level access to the TB for writing values to the TB. See Section 2.3.13, “Time Base Facility (TB)—OEA,” for more information.

In Figure 2-9, the numbers to the right of the register name indicates the number that is used in the syntax of the instruction operands to access the register (for example, the number used to access the XER is SPR 1).

Note that the general-purpose registers (GPRs), link register (LR), and count register (CTR) are 64 bits on 64-bit implementations and 32 bits on 32-bit implementations. These registers are described fully in Section 2.1, “PowerPC UISA Register Set.”

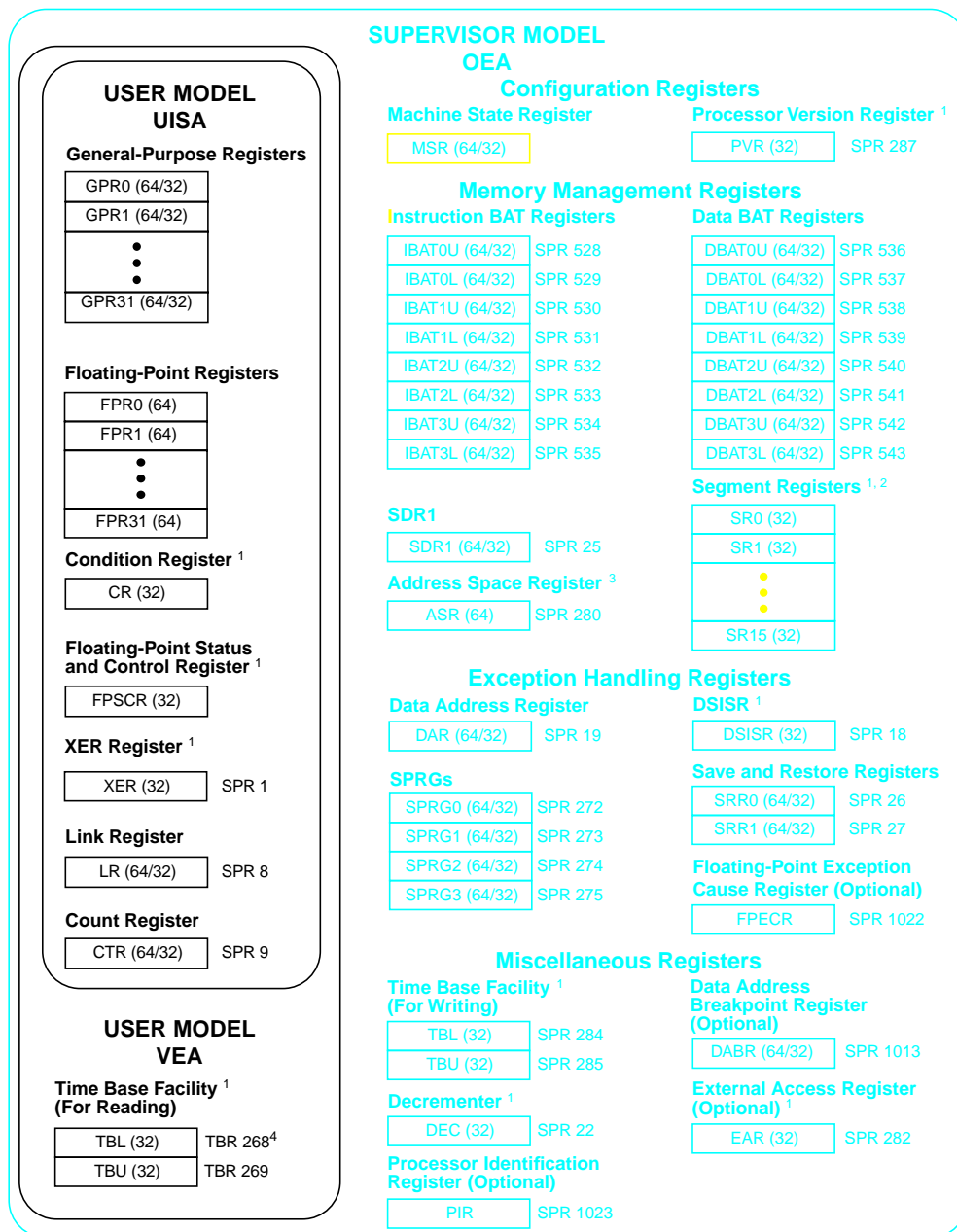

¹ These registers are 32-bit registers only.

² These registers are on 32-bit implementations only.

³ These registers are on 64-bit implementations only.

⁴ In 64-bit implementations, TBR268 is read as a 64-bit value.

Figure 2-9. VEA Programming Model—User-Level Registers Plus Time Base

The time base (TB), shown in Figure 2-10, is a 64-bit structure that contains a 64-bit unsigned integer that is incremented periodically. Each increment adds 1 to the low-order bit (bit 31 of TBL). The frequency at which the counter is incremented is implementation-dependent.

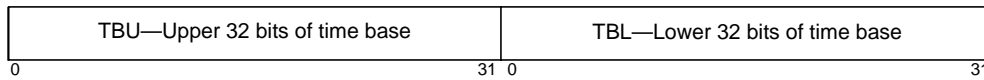

Figure 2-10. Time Base (TB)

The TB increments until its value becomes 0xFFFF_FFFF_FFFF_FFFF ($2^{64} - 1$). At the next increment its value becomes 0x0000_0000_0000_0000. Note that there is no explicit indication that this has occurred (that is, no exception is generated).

The period of the time base depends on the driving frequency. The TB is implemented such that the following requirements are satisfied:

1. Loading a GPR from the time base has no effect on the accuracy of the time base.
2. Storing a GPR to the time base replaces the value in the time base with the value in the GPR.

The PowerPC VEA does not specify a relationship between the frequency at which the time base is updated and other frequencies, such as the processor clock. The TB update frequency is not required to be constant; however, for the system software to maintain time of day and operate interval timers, one of two things is required:

- The system provides an implementation-dependent exception to software whenever the update frequency of the time base changes and a means to determine the current update frequency; or
- The system software controls the update frequency of the time base.

Note that if the operating system initializes the TB to some reasonable value and the update frequency of the TB is constant, the TB can be used as a source of values that increase at a constant rate, such as for time stamps in trace entries.

Even if the update frequency is not constant, values read from the TB are monotonically increasing (except when the TB wraps from $2^{64} - 1$ to 0). If a trace entry is recorded each time the update frequency changes, the sequence of TB values can be postprocessed to become actual time values.

However, successive readings of the time base may return identical values due to implementation-dependent factors such as a low update frequency or initialization.

2.2.1 Reading the Time Base

The **mftb** instruction is used to read the time base. The following sections discuss reading the time base on 64-bit and 32-bit implementations. For specific details on using the **mftb** instruction, see Chapter 8, “Instruction Set.” For information on writing the time base, see Section 2.3.13.1, “Writing to the Time Base.”

2.2.1.1 Reading the Time Base on 64-Bit Implementations

The contents of the time base may be read into a GPR by **mftb**. To read the contents of the TB into register **rD**, execute the following instruction:

```
mftb    rD
```

The above example uses the simplified mnemonic (referred to as extended mnemonic in the architecture specification) form of the **mftb** instruction (equivalent to **mftb rA,268**). Using this instruction on a 64-bit implementation copies the entire time base (TBU || TBL) into **rA**. Note that if the simplified mnemonic form **mftbu rA** (equivalent to **mftb rA,269**) is used on a 64-bit implementation, the contents of TBU are copied to the low-order 32 bits of **rA**, and the high-order 32 bits of **rA** are cleared (0 || TBU).

Reading the time base has no effect on the value it contains or the periodic incrementing of that value.

2.2.1.2 Reading the Time Base on 32-Bit Implementations

On 32-bit implementations, it is not possible to read the entire 64-bit time base in a single instruction. The **mftb** simplified mnemonic moves from the lower half of the time base register (TBL) to a GPR, and the **mftbu** simplified mnemonic moves from the upper half of the time base (TBU) to a GPR.

Because of the possibility of a carry from TBL to TBU occurring between reads of the TBL and TBU, a sequence such as the following example is necessary to read the time base on 32-bit implementations:

```
loop:
    mftbu    rx        #load from TBU
    mftb     ry        #load from TBL
    mftbu    rz        #load from TBU
    cmpw     rz,rx     #see if 'old' = 'new'
    bne     loop      #loop if carry occurred
```

The comparison and loop are necessary to ensure that a consistent pair of values has been obtained. The previous example will also work on 64-bit implementations running in either 64-bit or 32-bit mode.

2.2.2 Computing Time of Day from the Time Base

Since the update frequency of the time base is system-dependent, the algorithm for converting the current value in the time base to time of day is also system-dependent.

In a system in which the update frequency of the time base may change over time, it is not possible to convert an isolated time base value into time of day. Instead, a time base value has meaning only with respect to the current update frequency and the time of day that the update frequency was last changed. Each time the update frequency changes, either the system software is notified of the change via an exception, or else the change was instigated by the system software itself. At each such change, the system software must compute the current time of day using the old update frequency, compute a new value of ticks-per-second for the new frequency, and save the time of day, time base value, and tick rate. Subsequent calls to compute time of day use the current time base value and the saved data.

A generalized service to compute time of day could take the following as input:

- Time of day at beginning of current epoch
- Time base value at beginning of current epoch
- Time base update frequency
- Time base value for which time of day is desired

For a PowerPC system in which the time base update frequency does not vary, the first three inputs would be constant.

2.3 PowerPC OEA Register Set

The PowerPC operating environment architecture (OEA) completes the discussion of PowerPC registers. Figure 2-11 shows a graphic representation of the entire PowerPC register set—UISA, VEA, and OEA. In Figure 2-11 the numbers to the right of the register name indicates the number that is used in the syntax of the instruction operands to access the register (for example, the number used to access the XER is SPR 1).

All of the SPRs in the OEA can be accessed only by supervisor-level instructions; any attempt to access these SPRs with user-level instructions results in a supervisor-level exception. Some SPRs are implementation-specific. In some cases, not all of a register's bits are implemented in hardware.

If a PowerPC processor executes an **mtspr/mfspr** instruction with an undefined SPR encoding, it takes (depending on the implementation) an illegal instruction program exception, a privileged instruction program exception, or the results are boundedly undefined. See Section 6.4.7, “Program Exception (0x00700),” for more information.

Note that the GPRs, LR, CTR, TBL, MSR, DAR, SDR1, SRR0, SRR1, and SPRG0–SPRG3 are 64 bits wide on 64-bit implementations and 32 bits wide on 32-bit implementations.

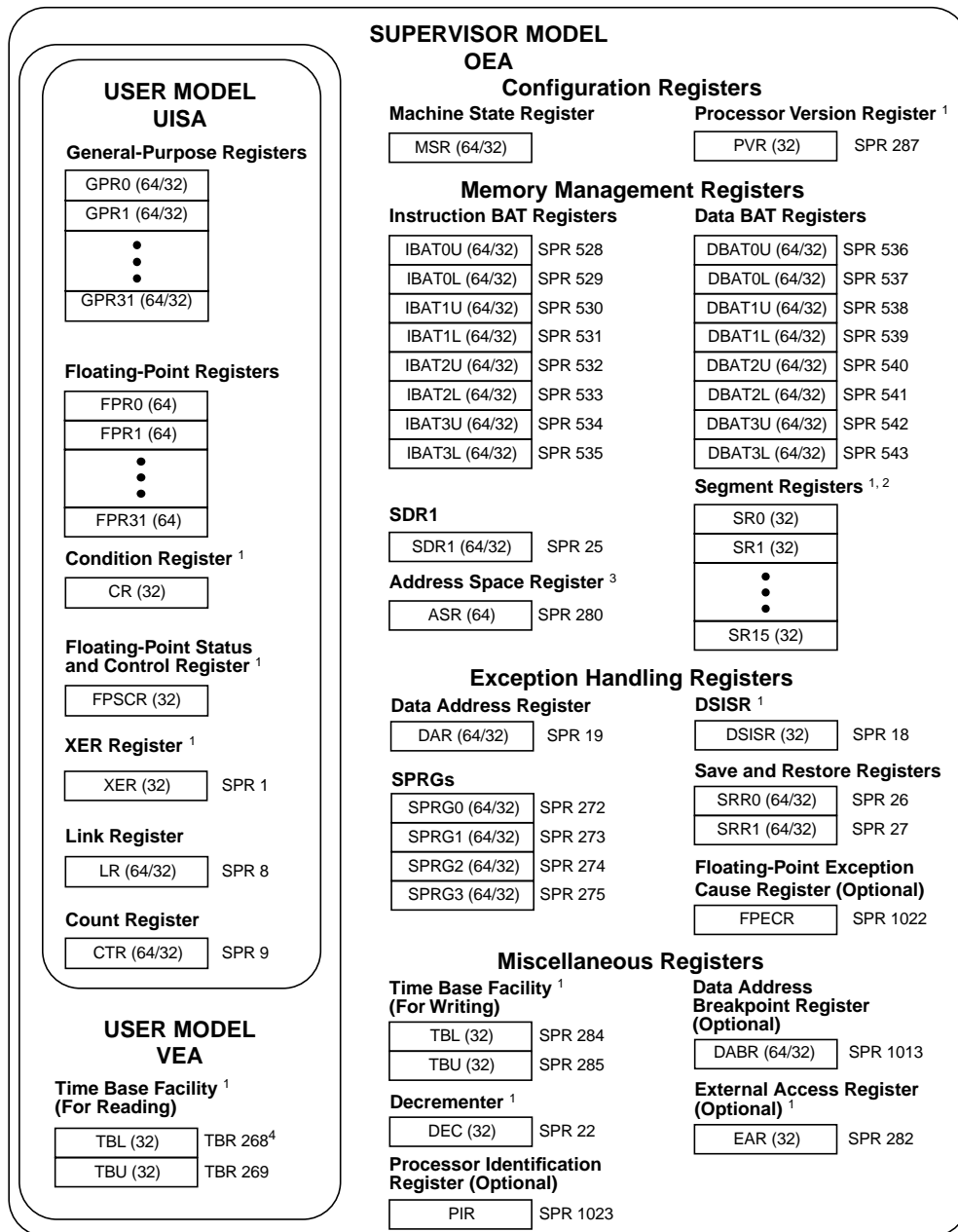

¹ These registers are 32-bit registers only.
² These registers are on 32-bit implementations only.
³ These registers are on 64-bit implementations only.
⁴ In 64-bit implementations, TBR268 is read as a 64-bit value

Figure 2-11. OEA Programming Model—All Registers

A description of the PowerPC OEA supervisor-level registers follows:

- **Configuration registers**

- Machine state register (MSR). The MSR defines the state of the processor. The MSR can be modified by the Move to Machine State Register (**mtmsrd** [or **mtmsr**]), System Call (**sc**), and Return from Interrupt (**rfd** [or **rfi**]) instructions. It can be read by the Move from Machine State Register (**mfmsr**) instruction. For more information, see Section 2.3.1, “Machine State Register (MSR).”
- Processor version register (PVR). This register is a read-only register that identifies the version (model) and revision level of the PowerPC processor. For more information, see Section 2.3.2, “Processor Version Register (PVR).”

- **Memory management registers**

- Block-address translation (BAT) registers. The PowerPC OEA includes eight block-address translation registers (BATs), consisting of four pairs of instruction BATs (IBAT0U–IBAT3U and IBAT0L–IBAT3L) and four pairs of data BATs (DBAT0U–DBAT3U and DBAT0L–DBAT3L). See Figure 2-11 for a list of the SPR numbers for the BAT registers. Refer to Section 2.3.3, “BAT Registers,” for more information.
- SDR1. The SDR1 register specifies the page table base address used in virtual-to-physical address translation. For more information, see Section 2.3.4, “SDR1.” (Note that physical address is referred to as real address in the architecture specification.)
- Address space register (ASR). The ASR holds the physical address of the segment table. It is found only on 64-bit implementations. For more information, see Section 2.3.5, “Address Space Register (ASR).”
- Segment registers (SR). The PowerPC OEA defines sixteen 32-bit segment registers (SR0–SR15). Note that the SRs are implemented on 32-bit implementations only. The fields in the segment register are interpreted differently depending on the value of bit 0. For more information, see Section 2.3.6, “Segment Registers.” Note that the 64-bit bridge facility defines a way in which 64-bit implementations can use 16 SLB entries as if they were segment registers. See Chapter 7, “Memory Management,” for more detailed information about the bridge facility.

- **Exception handling registers**

- Data address register (DAR). After a DSI or an alignment exception, DAR is set to the effective address generated by the faulting instruction. For more information, see Section 2.3.7, “Data Address Register (DAR).”
- SPRG0–SPRG3. The SPRG0–SPRG3 registers are provided for operating system use. For more information, see Section 2.3.8, “SPRG0–SPRG3.”
- DSISR. The DSISR defines the cause of DSI and alignment exceptions. For more information, refer to Section 2.3.9, “DSISR.”

- Machine status save/restore register 0 (SRR0). The SRR0 register is used to save machine status on exceptions and to restore machine status when an **rfd** (or **rfi**) instruction is executed. For more information, see Section 2.3.10, “Machine Status Save/Restore Register 0 (SRR0).”
- Machine status save/restore register 1 (SRR1). The SRR1 register is used to save machine status on exceptions and to restore machine status when an **rfd** (or **rfi**) instruction is executed. For more information, see Section 2.3.11, “Machine Status Save/Restore Register 1 (SRR1).”
- Floating-point exception cause register (FPECR). This optional register is used to identify the cause of a floating-point exception.
- **Miscellaneous registers**
 - Time base (TB). The TB is a 64-bit structure that maintains the time of day and operates interval timers. The TB consists of two 32-bit registers—time base upper (TBU) and time base lower (TBL). Note that the time base registers can be accessed by both user- and supervisor-level instructions. For more information, see Section 2.3.13, “Time Base Facility (TB)—OEA” and Section 2.2, “PowerPC VEA Register Set—Time Base.”
 - Decrementer register (DEC). This register is a 32-bit decrementing counter that provides a mechanism for causing a decrementer exception after a programmable delay; the frequency is a subdivision of the processor clock. For more information, see Section 2.3.14, “Decrementer Register (DEC).”
 - External access register (EAR). This optional register is used in conjunction with the **eciwx** and **ecowx** instructions. Note that the EAR register and the **eciwx** and **ecowx** instructions are optional in the PowerPC architecture and may not be supported in all PowerPC processors that implement the OEA. For more information about the external control facility, see Section 4.3.4, “External Control Instructions.”
 - Data address breakpoint register (DABR). This optional register is used to control the data address breakpoint facility. Note that the DABR is optional in the PowerPC architecture and may not be supported in all PowerPC processors that implement the OEA. For more information about the data address breakpoint facility, see Section 6.4.3, “DSI Exception (0x00300).”
 - Processor identification register (PIR). This optional register is used to hold a value that distinguishes an individual processor in a multiprocessor environment.

2.3.1 Machine State Register (MSR)

The machine state register (MSR) is a 64-bit register on 64-bit implementations (see Figure 2-12) and a 32-bit register in 32-bit implementations (see Figure 2-13). The MSR defines the state of the processor. When an exception occurs, MSR bits, as described in Table 2-8, are altered as determined by the exception. The MSR can also be modified by the **mtmsrd** (or **mtmsr**), **sc**, and **rfd** (or **rfi**) instructions. It can be read by the **mfmsr** instruction.

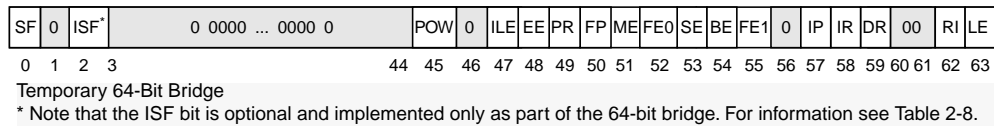

Figure 2-12. Machine State Register (MSR)—64-Bit Implementations

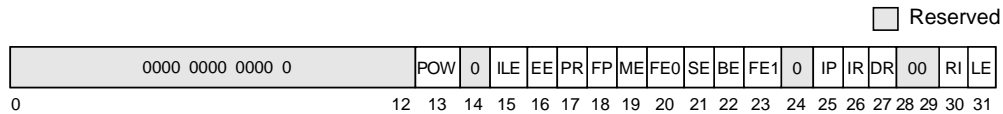

Figure 2-13. Machine State Register (MSR)—32-Bit Implementations

Table 2-8 shows the bit definitions for the MSR.

Table 2-8. MSR Bit Settings

Bit(s)		Name	Description
64 Bit	32 Bit		
0	—	SF	Sixty-four bit mode 0 The 64-bit processor runs in 32-bit mode. 1 The 64-bit processor runs in 64-bit mode. Note that this is the default setting.
1	—	—	Reserved
TEMPORARY 64-BIT BRIDGE 2	—	ISF	Exception 64-bit mode (optional). When an exception occurs, this bit is copied into MSR[SF] to select 64- or 32-bit mode for the context established by the exception. Note: If the bridge function is not implemented, this bit is treated as reserved.
3–44	0–12	—	Reserved
45	13	POW	Power management enable 0 Power management disabled (normal operation mode) 1 Power management enabled (reduced power mode) Note: Power management functions are implementation-dependent. If the function is not implemented, this bit is treated as reserved.
46	14	—	Reserved
47	15	ILE	Exception little-endian mode. When an exception occurs, this bit is copied into MSR[LE] to select the endian mode for the context established by the exception.
48	16	EE	External interrupt enable 0 While the bit is cleared, the processor delays recognition of external interrupts and decremter exception conditions. 1 The processor is enabled to take an external interrupt or the decremter exception.

Table 2-8. MSR Bit Settings (Continued)

Bit(s)		Name	Description
64 Bit	32 Bit		
49	17	PR	Privilege level 0 The processor can execute both user- and supervisor-level instructions. 1 The processor can only execute user-level instructions.
50	18	FP	Floating-point available 0 The processor prevents dispatch of floating-point instructions, including floating-point loads, stores, and moves. 1 The processor can execute floating-point instructions.
51	19	ME	Machine check enable 0 Machine check exceptions are disabled. 1 Machine check exceptions are enabled.
52	20	FE0	Floating-point exception mode 0 (see Table 2-9).
53	21	SE	Single-step trace enable (Optional) 0 The processor executes instructions normally. 1 The processor generates a single-step trace exception upon the successful execution of the next instruction. Note: If the function is not implemented, this bit is treated as reserved.
54	22	BE	Branch trace enable (Optional) 0 The processor executes branch instructions normally. 1 The processor generates a branch trace exception after completing the execution of a branch instruction, regardless of whether the branch was taken. Note: If the function is not implemented, this bit is treated as reserved.
55	23	FE1	Floating-point exception mode 1 (See Table 2-9).
56	24	—	Reserved
57	25	IP	Exception prefix. The setting of this bit specifies whether an exception vector offset is prepended with Fs or 0s. In the following description, <i>nnnn</i> is the offset of the exception vector. See Table 6-2. 0 Exceptions are vectored to the physical address 0x000n_nnnn in 32-bit implementations and 0x0000_0000_000n_nnnn in 64-bit implementations. 1 Exceptions are vectored to the physical address 0xFFFFn_nnnn in 32-bit implementations and 0x0000_0000_FFFn_nnnn in 64-bit implementations. In most systems, IP is set to 1 during system initialization, and then cleared to 0 when initialization is complete.
58	26	IR	Instruction address translation 0 Instruction address translation is disabled. 1 Instruction address translation is enabled. For more information, see Chapter 7, "Memory Management."
59	27	DR	Data address translation 0 Data address translation is disabled. 1 Data address translation is enabled. For more information, see Chapter 7, "Memory Management."
60–61	28–29	—	Reserved

Table 2-8. MSR Bit Settings (Continued)

Bit(s)		Name	Description
64 Bit	32 Bit		
62	30	RI	Recoverable exception (for system reset and machine check exceptions). 0 Exception is not recoverable. 1 Exception is recoverable. For more information, see Chapter 6, "Exceptions."
63	31	LE	Little-endian mode enable 0 The processor runs in big-endian mode. 1 The processor runs in little-endian mode.

The floating-point exception mode bits (FE0–FE1) are interpreted as shown in Table 2-9.

Table 2-9. Floating-Point Exception Mode Bits

FE0	FE1	Mode
0	0	Floating-point exceptions disabled
0	1	Floating-point imprecise nonrecoverable
1	0	Floating-point imprecise recoverable
1	1	Floating-point precise mode

Table 2-10 indicates the initial state of the MSR at power up.

Table 2-10. State of MSR at Power Up

Bit(s)		Name	64-Bit Default Value	32-Bit Default Value
64 Bit	32 Bit			
0	—	SF	1	—
1	—	—	Unspecified ¹	—
TEMPORARY 64-BIT BRIDGE 2	—	ISF	1	—
3–44	0–12	—	Unspecified ¹	Unspecified ¹
45	13	POW	0	0
46	14	—	Unspecified ¹	Unspecified ¹
47	15	ILE	0	0
48	16	EE	0	0
49	17	PR	0	0
50	18	FP	0	0
51	19	ME	0	0
52	20	FE0	0	0

Table 2-10. State of MSR at Power Up (Continued)

Bit(s)		Name	64-Bit Default Value	32-Bit Default Value
64 Bit	32 Bit			
53	21	SE	0	0
54	22	BE	0	0
55	23	FE1	0	0
56	24	—	Unspecified ¹	Unspecified ¹
57	25	IP	1 ²	1 ²
58	26	IR	0	0
59	27	DR	0	0
60–61	28–29	—	Unspecified ¹	Unspecified ¹
62	30	RI	0	0
63	31	LE	0	0

Notes: ¹ Unspecified can be either 0 or 1

² 1 is typical, but might be 0

2.3.2 Processor Version Register (PVR)

The processor version register (PVR) is a 32-bit, read-only register that contains a value identifying the specific version (model) and revision level of the PowerPC processor (see Figure 2-14). The contents of the PVR can be copied to a GPR by the **mfspr** instruction. Read access to the PVR is supervisor-level only; write access is not provided.

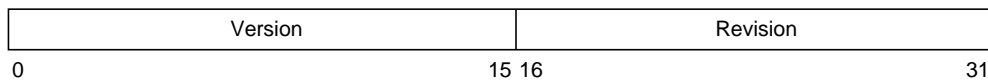
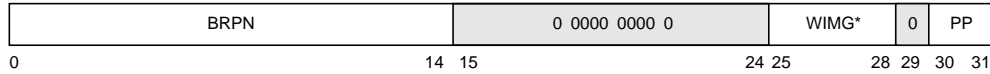

Figure 2-14. Processor Version Register (PVR)

The PVR consists of two 16-bit fields:

- Version (bits 0–15)—A 16-bit number that uniquely identifies a particular processor version. This number can be used to determine the version of a processor; it may not distinguish between different end product models if more than one model uses the same processor.
- Revision (bits 16–31)—A 16-bit number that distinguishes between various releases of a particular version (that is, an engineering change level). The value of the revision portion of the PVR is implementation-specific. The processor revision level is changed for each revision of the device.

☐ Reserved



*W and G bits are not defined for IBAT registers. Attempting to write to these bits causes boundedly-undefined results.

Figure 2-18. Lower BAT Register—32-Bit Implementations

Table 2-11 describes the bits in the BAT registers.

Table 2-11. BAT Registers—Field and Bit Descriptions

Upper/ Lower BAT	Bits		Name	Description
	64 Bit	32 Bit		
Upper BAT Register	0–46	0–14	BEPI	Block effective page index. This field is compared with high-order bits of the logical address to determine if there is a hit in that BAT array entry. (Note that the architecture specification refers to logical address as effective address.)
	46–50	15–18	—	Reserved
	51–61	19–29	BL	Block length. BL is a mask that encodes the size of the block. Values for this field are listed in Table 2-12.
	62	30	Vs	Supervisor mode valid bit. This bit interacts with MSR[PR] to determine if there is a match with the logical address. For more information, see Section 7.4.2, “Recognition of Addresses in BAT Arrays.”
	63	31	Vp	User mode valid bit. This bit also interacts with MSR[PR] to determine if there is a match with the logical address. For more information, see Section 7.4.2, “Recognition of Addresses in BAT Arrays.”
Lower BAT Register	0–46	0–14	BRPN	This field is used in conjunction with the BL field to generate high-order bits of the physical address of the block.
	47–56	15–24	—	Reserved
	57–60	25–28	WIMG	Memory/cache access mode bits W Write-through I Caching-inhibited M Memory coherence G Guarded Attempting to write to the W and G bits in IBAT registers causes boundedly-undefined results. For detailed information about the WIMG bits, see Section 5.2.1, “Memory/Cache Access Attributes.”
	61	29	—	Reserved
	62–63	30–31	PP	Protection bits for block. This field determines the protection for the block as described in Section 7.4.4, “Block Memory Protection.”

Table 2-12 lists the BAT area lengths encoded in BAT[BL].

Table 2-12. BAT Area Lengths

BAT Area Length	BL Encoding
128 Kbytes	000 0000 0000
256 Kbytes	000 0000 0001
512 Kbytes	000 0000 0011
1 Mbyte	000 0000 0111
2 Mbytes	000 0000 1111
4 Mbytes	000 0001 1111
8 Mbytes	000 0011 1111
16 Mbytes	000 0111 1111
32 Mbytes	000 1111 1111
64 Mbytes	001 1111 1111
128 Mbytes	011 1111 1111
256 Mbytes	111 1111 1111

Only the values shown in Table 2-12 are valid for the BL field. The rightmost bit of BL is aligned with bit 46 (bit 14 for 32-bit implementations) of the logical address. A logical address is determined to be within a BAT area if the logical address matches the value in the BEPI field.

The boundary between the cleared bits and set bits (0s and 1s) in BL determines the bits of logical address that participate in the comparison with BEPI. Bits in the logical address corresponding to set bits in BL are cleared for this comparison. Bits in the logical address corresponding to set bits in the BL field, concatenated with the 17 bits of the logical address to the right (less significant bits) of BL, form the offset within the BAT area. This is described in detail in Chapter 7, “Memory Management.”

The value loaded into BL determines both the length of the BAT area and the alignment of the area in both logical and physical address space. The values loaded into BEPI and BRPN must have at least as many low-order zeros as there are ones in BL.

Use of BAT registers is described in Chapter 7, “Memory Management.”

2.3.4 SDR1

The SDR1 is a 64-bit register in 64-bit implementations and a 32-bit register in 32-bit implementations. The 64-bit implementation of SDR1 is shown in Figure 2-19.

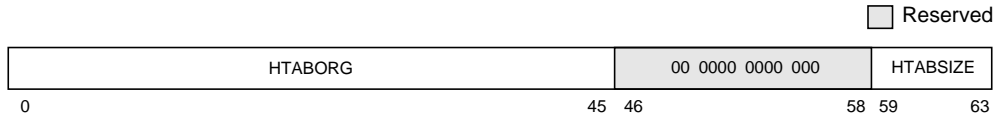

Figure 2-19. SDR1—64-Bit Implementations

The bits of the 64-bit implementation of SDR1 are described in Table 2-13.

Table 2-13. SDR1 Bit Settings—64-Bit Implementations

Bits	Name	Description
0–45	HTABORG	Physical base address of page table
46–58	—	Reserved
59–63	HTABSIZE	Encoded size of page table (used to generate mask)

In 64-bit implementations the HTABORG field in SDR1 contains the high-order 46 bits of the 64-bit physical address of the page table. Therefore, the page table is constrained to lie on a 2^{18} -byte (256 Kbytes) boundary at a minimum. At least 11 bits from the hash function are used to index into the page table. The page table must consist of at least 256 Kbytes (2^{11} PTEGs of 128 bytes each).

The page table can be any size 2^n where $18 \leq n \leq 46$. As the table size is increased, more bits are used from the hash to index into the table and the value in HTABORG must have more of its low-order bits equal to 0. The HTABSIZE field in SDR1 contains an integer value that determines how many bits from the hash are used in the page table index. This number must not exceed 28. HTABSIZE is used to generate a mask of the form 0b00...011...1; that is, a string of 0 bits followed by a string of 1 bits. The 1 bits determine how many additional bits (at least 11) from the hash are used in the index; HTABORG must have this same number of low-order bits equal to 0. See Figure 7-35 for an example of the primary PTEG address generation in a 64-bit implementation.

For example, suppose that the page table is 16,384 (2^{14}), 128-byte PTEGs, for a total size of 2^{21} bytes (2 Mbytes). Note that a 14-bit index is required. Eleven bits are provided from the hash initially, so three additional bits from the hash must be selected. The value in HTABSIZE must be 3 and the value in HTABORG must have its low-order three bits (bits 31–33 of SDR1) equal to 0. This means that the page table must begin on a $2^3 + 11 + 7 = 2^{21} = 2$ Mbytes boundary.

On implementations that support a virtual address size of only 64 bits, software should set the HTABSIZE field to a value that does not exceed 25. Because the high-order 16 bits of

the VSID must be zeros for these implementations, the hash value used in the page table search will have the high-order three bits either all zeros (primary hash) or all ones (secondary hash). If HTABSIZE > 25, some of these hash value bits will be used to index into the page table, resulting in certain PTEGs never being searched.

The 32-bit implementation of SDR1 is shown in Figure 2-20.

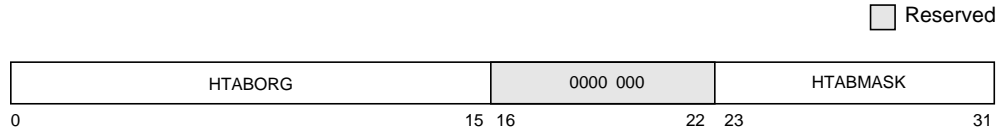

Figure 2-20. SDR1—32-Bit Implementations

The bits of the 32-bit implementation of SDR1 are described in Table 2-14.

Table 2-14. SDR1 Bit Settings—32-Bit Implementations

Bits	Name	Description
0–15	HTABORG	The high-order 16 bits of the 32-bit physical address of the page table
16–22	—	Reserved
23–31	HTABMASK	Mask for page table address

In 32-bit implementations, the HTABORG field in SDR1 contains the high-order 16 bits of the 32-bit physical address of the page table. Therefore, the page table is constrained to lie on a 2^{16} -byte (64 Kbytes) boundary at a minimum. At least 10 bits from the hash function are used to index into the page table. The page table must consist of at least 64 Kbytes (2^{10} PTEGs of 64 bytes each).

The page table can be any size 2^n where $16 \leq n \leq 25$. As the table size is increased, more bits are used from the hash to index into the table and the value in HTABORG must have more of its low-order bits equal to 0. The HTABMASK field in SDR1 contains a mask value that determines how many bits from the hash are used in the page table index. This mask must be of the form 0b00...011...1; that is, a string of 0 bits followed by a string of 1 bits. The 1 bits determine how many additional bits (at least 10) from the hash are used in the index; HTABORG must have this same number of low-order bits equal to 0. See Figure 7-37 for an example of the primary PTEG address generation in a 32-bit implementation.

For example, suppose that the page table is 8,192 (2^{13}), 64-byte PTEGs, for a total size of 2^{19} bytes (512 Kbytes). Note that a 13-bit index is required. Ten bits are provided from the hash initially, so 3 additional bits from the hash must be selected. The value in HTABMASK must be 0x007 and the value in HTABORG must have its low-order 3 bits (bits 13–15 of SDR1) equal to 0. This means that the page table must begin on a $2^{3+10+6} = 2^{19} = 512$ Kbytes boundary.

For more information, refer to Chapter 7, “Memory Management.”

2.3.5 Address Space Register (ASR)

The ASR, shown in Figure 2-21, is a 64-bit SPR that holds bits 0–51 of the segment table’s physical address. The segment table contains the segment table entries for 64-bit implementations. The segment table defines the set of segments that can be addressed at any one time. Note that the ASR is defined only for 64-bit implementations.

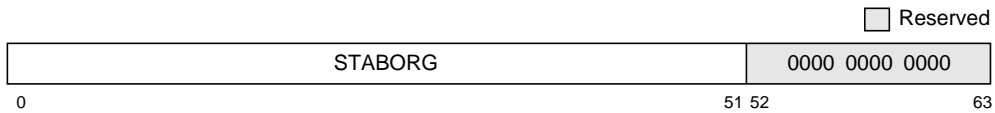

Figure 2-21. Address Space Register (ASR)—64-Bit Implementations Only

The bits of the ASR are described in Table 2-15.

Table 2-15. ASR Bit Settings

Bits	Name	Description
0–51	STABORG	Physical address of segment table
52–63	—	Reserved

The following values, 0x0000_0000_0000_0000, 0x0000_0000_0000_1000, and 0x0000_0000_0000_2000, cannot be used as segment table addresses, since these pages correspond to areas of the exception vector table reserved for implementation-specific purposes. For more information, see Chapter 7, “Memory Management.”

TEMPORARY 64-BIT BRIDGE

Some 64-bit processors implement optional features that simplify the conversion of an operating system from the 32-bit to the 64-bit portion of the architecture. This architecturally-defined bridge allows the option of defining bit 63 as ASR[V], the STABORG field valid bit.

If the ASR[V] bit is implemented and is set, the ASR[STABORG] field is valid and functions are as described for the 64-bit architecture. However, if the ASR[V] bit is implemented and ASR[V] and MSR[SF] are cleared, an operating system can use 16 SLB entries similarly to the way 32-bit implementations use the segment registers, which are otherwise not supported in the 64-bit architecture. Note that if ASR[V] = 0, a reference to a nonexistent address in the STABORG field does not cause a machine check exception. For more information, see Section 7.7.1.1, “Address Space Register (ASR).”

The ASR, with the optional V bit implemented, is shown in Figure 2-22.

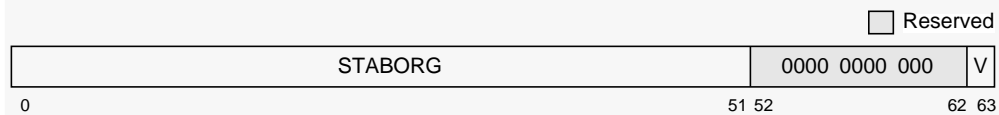

Figure 2-22. Address Space Register (ASR)—64-Bit Bridge

The bits of the ASR, including the optional V bit, are described in Table 2-16.

Table 2-16. ASR Bit Settings—64-Bit Bridge

Bits	Name	Description
0–51	STABORG	Physical address of segment table
52–62	—	Reserved
63	V	STABORG field valid (V = 1) or invalid (V = 0). Note that the V bit of the ASR is optional. If the function is not implemented, this bit is treated as reserved, except that it is assumed to be set for address translation.

2.3.6 Segment Registers

The segment registers contain the segment descriptors for 32-bit implementations. For 32-bit processors, the OEA defines a segment register file of sixteen 32-bit registers. Segment registers can be accessed by using the **mtsr/mfsr** and **mtsrin/mfsrin** instructions. The value of bit 0, the T bit, determines how the remaining register bits are interpreted. Figure 2-23 shows the format of a segment register when T = 0.

Reserved



Figure 2-23. Segment Register Format (T = 0)

Segment register bit settings when T = 0 are described in Table 2-17.

Table 2-17. Segment Register Bit Settings (T = 0)

Bits	Name	Description
0	T	T = 0 selects this format
1	Ks	Supervisor-state protection key
2	Kp	User-state protection key
3	N	No-execute protection
4–7	—	Reserved
8–31	VSID	Virtual segment ID

Figure 2-24 shows the bit definition when T = 1.

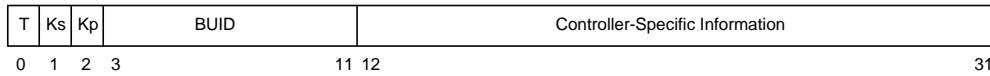

Figure 2-24. Segment Register Format (T = 1)

The bits in the segment register when T = 1 are described in Table 2-18.

Table 2-18. Segment Register Bit Settings (T = 1)

Bits	Name	Description
0	T	T = 1 selects this format.
1	Ks	Supervisor-state protection key
2	Kp	User-state protection key
3–11	BUID	Bus unit ID
12–31	CNTLR_SPEC	Device-specific data for I/O controller

If an access is translated by the block address translation (BAT) mechanism, the BAT translation takes precedence and the results of translation using segment registers are not used. However, if an access is not translated by a BAT, and $T = 0$ in the selected segment register, the effective address is a reference to a memory-mapped segment. In this case, the 52-bit virtual address (VA) is formed by concatenating the following:

- The 24-bit VSID field from the segment register
- The 16-bit page index, EA[4–19]
- The 12-bit byte offset, EA[20–31]

The VA is then translated to a physical address as described in Section 7.5, “Memory Segment Model.”

If $T = 1$ in the selected segment register (and the access is not translated by a BAT), the effective address is a reference to a direct-store segment. No reference is made to the page tables. However, note that the direct-store facility is being phased out of the architecture and will not likely be supported in future devices. Thus, all new programs should write a value of zero to the T bit. For further discussion of address translation when $T = 1$, see Section 7.8, “Direct-Store Segment Address Translation.”

2.3.7 Data Address Register (DAR)

The DAR is a 64-bit register in 64-bit implementations and a 32-bit register in 32-bit implementations. The DAR is shown in Figure 2-25.

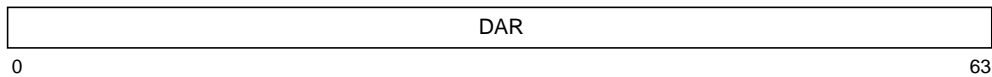

Figure 2-25. Data Address Register (DAR)

The effective address generated by a memory access instruction is placed in the DAR if the access causes an exception (for example, an alignment exception). If the exception occurs in a 64-bit implementation operating in 32-bit mode, the high-order 32 bits of the DAR are cleared. For information, see Chapter 6, “Exceptions.”

2.3.8 SPRG0–SPRG3

SPRG0–SPRG3 are 64-bit or 32-bit registers, depending on the type of PowerPC processor. They are provided for general operating system use, such as performing a fast state save or for supporting multiprocessor implementations. The formats of SPRG0–SPRG3 are shown in Figure 2-26.

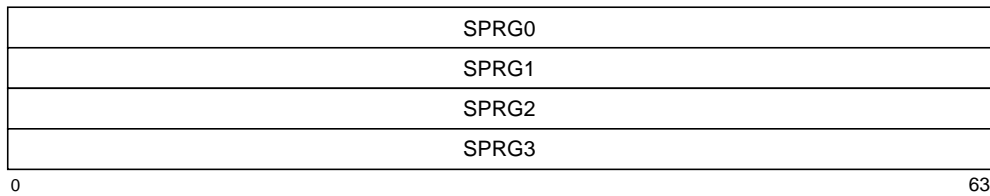

Figure 2-26. SPRG0–SPRG3

Table 2-19 provides a description of conventional uses of SPRG0 through SPRG3.

Table 2-19. Conventional Uses of SPRG0–SPRG3

Register	Description
SPRG0	Software may load a unique physical address in this register to identify an area of memory reserved for use by the first-level exception handler. This area must be unique for each processor in the system.
SPRG1	This register may be used as a scratch register by the first-level exception handler to save the content of a GPR. That GPR then can be loaded from SPRG0 and used as a base register to save other GPRs to memory.
SPRG2	This register may be used by the operating system as needed.
SPRG3	This register may be used by the operating system as needed.

2.3.9 DSISR

The 32-bit DSISR, shown in Figure 2-27, identifies the cause of DSI and alignment exceptions.

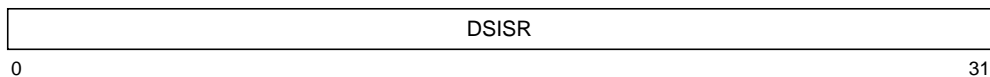

Figure 2-27. DSISR

For information about bit settings, see Section 6.4.3, “DSI Exception (0x00300),” and Section 6.4.6, “Alignment Exception (0x00600).”

2.3.10 Machine Status Save/Restore Register 0 (SRR0)

The SRR0 is a 64-bit register in 64-bit implementations and a 32-bit register in 32-bit implementations. SRR0 is used to save machine status on exceptions and restore machine status when an **rfd** (or **rfi**) instruction is executed. It also holds the EA for the instruction that follows the System Call (**sc**) instruction. The format of SRR0 is shown in Figure 2-28. For 32-bit implementations, the format of SRR0 is that of the low-order bits (32–63) of Figure 2-28.

☐ Reserved

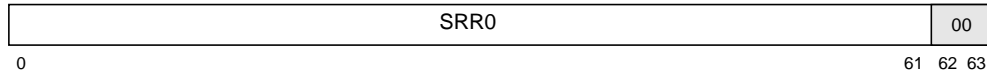

Figure 2-28. Machine Status Save/Restore Register 0 (SRR0)

When an exception occurs, SRR0 is set to point to an instruction such that all prior instructions have completed execution and no subsequent instruction has begun execution. When an **rfd** (or **rfi**) instruction is executed, the contents of SRR0 are copied to the next instruction address (NIA)—the 64- or 32-bit address of the next instruction to be executed. The instruction addressed by SRR0 may not have completed execution, depending on the exception type. SRR0 addresses either the instruction causing the exception or the immediately following instruction. The instruction addressed can be determined from the exception type and status bits.

If the exception occurs in 32-bit mode of a 64-bit implementation, the high-order 32 bits of the NIA are cleared, NIA[32–61] are set from SRR0[32–61], and the two least significant bits of NIA are cleared.

Note that in some implementations, every instruction fetch performed while MSR[IR] = 1, and every instruction execution requiring address translation when MSR[DR] = 1, may modify SRR0.

For information on how specific exceptions affect SRR0, refer to the descriptions of individual exceptions in Chapter 6, “Exceptions.”

2.3.11 Machine Status Save/Restore Register 1 (SRR1)

The SRR1 is a 64-bit register in 64-bit implementations and a 32-bit register in 32-bit implementations. SRR1 is used to save machine status on exceptions and to restore machine status when an **rfd** (or **rfi**) instruction is executed. The format of SRR1 is shown in Figure 2-29.

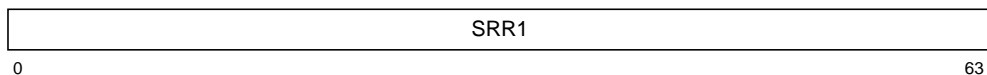

Figure 2-29. Machine Status Save/Restore Register 1 (SRR1)

In 64-bit implementations, when an exception occurs, bits 33–36 and 42–47 of SRR1 are loaded with exception-specific information and bits 0, 48–55, 57–59, and 62–63 of MSR are placed into the corresponding bit positions of SRR1. When **rfd** is executed, MSR[0, 48–55, 57–59, 62–63] are loaded from SRR1[0, 48–55, 57–59, 62–63].

For 32-bit implementations, when an exception occurs, bits 1–4 and 10–15 of SRR1 are loaded with exception-specific information and bits 16–23, 25–27, and 30–31 of MSR are placed into the corresponding bit positions of SRR1. When **rfi** is executed, MSR[16–23, 25–27, 30–31] are loaded from SRR1[16–23, 25–27, 30–31].

The remaining bits of SRR1 are defined as reserved. An implementation may define one or more of these bits, and in this case, may also cause them to be saved from MSR on an exception and restored to MSR from SRR1 on an **rfi**.

Note that, in some implementations, every instruction fetch when MSR[IR] = 1, and every instruction execution requiring address translation when MSR[DR] = 1, may modify SRR1.

For information on how specific exceptions affect SRR1, refer to the individual exceptions in Chapter 6, “Exceptions.”

2.3.12 Floating-Point Exception Cause Register (FPECR)

The FPECR register may be used to identify the cause of a floating-point exception. Note that the FPECR is an optional register in the PowerPC architecture and may be implemented differently (or not at all) in the design of each processor. The user’s manual of a specific processor will describe the functionality of the FPECR, if it is implemented in that processor.

2.3.13 Time Base Facility (TB)—OEA

As described in Section 2.2, “PowerPC VEA Register Set—Time Base,” the time base (TB) provides a long-period counter driven by an implementation-dependent frequency. The VEA defines user-level read-only access to the TB. Writing to the TB is reserved for supervisor-level applications such as operating systems and boot-strap routines. The OEA defines supervisor-level, write access to the TB.

The TB is a volatile resource and must be initialized during reset. Some implementations may initialize the TB with a known value; however, there is no guarantee of automatic initialization of the TB when the processor is reset. The TB runs continuously at start-up.

For more information on the user-level aspects of the time base, refer to Section 2.2, “PowerPC VEA Register Set—Time Base.”

2.3.13.1 Writing to the Time Base

Note that writing to the TB is reserved for supervisor-level software.

The simplified mnemonics, **mttbl** and **mttbu**, write the lower and upper halves of the TB, respectively. The simplified mnemonics listed above are for the **mtspr** instruction; see Appendix F, “Simplified Mnemonics,” for more information. The **mtspr**, **mttbl**, and **mttbu** instructions treat TBL and TBU as separate 32-bit registers; setting one leaves the other unchanged. It is not possible to write the entire 64-bit time base in a single instruction.

The instructions for writing the time base are not dependent on the implementation or mode. Thus, code written to set the TB on a 32-bit implementation will work correctly on a 64-bit implementation running in either 64- or 32-bit mode.

The TB can be written by a sequence such as:

```

lwz    rx,upper          #load 64-bit value for
lwz    ry,lower         # TB into rx and ry
li     rz,0
mttbl  rz               #force TBL to 0
mttbu  rx               #set TBU
mttbl  ry               #set TBL

```

Provided that no exceptions occur while the last three instructions are being executed, loading 0 into TBL prevents the possibility of a carry from TBL to TBU while the time base is being initialized.

For information on reading the time base, refer to Section 2.2.1, “Reading the Time Base.”

2.3.14 Decrementer Register (DEC)

The decrementer register (DEC), shown in Figure 2-30, is a 32-bit decrementing counter that provides a mechanism for causing a decrementer exception after a programmable delay. The DEC frequency is based on the same implementation-dependent frequency that drives the time base.

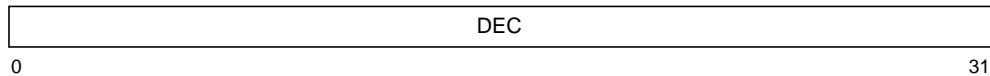

Figure 2-30. Decrementer Register (DEC)

2.3.14.1 Decrementer Operation

The DEC counts down, causing an exception (unless masked by MSR[EE]) when it passes through zero. The DEC satisfies the following requirements:

- The operation of the time base and the DEC are coherent (that is, the counters are driven by the same fundamental time base).
- Loading a GPR from the DEC has no effect on the DEC.
- Storing the contents of a GPR to the DEC replaces the value in the DEC with the value in the GPR.
- Whenever bit 0 of the DEC changes from 0 to 1, a decrementer exception request is signaled. Multiple DEC exception requests may be received before the first exception occurs; however, any additional requests are canceled when the exception occurs for the first request.
- If the DEC is altered by software and the content of bit 0 is changed from 0 to 1, an exception request is signaled.

2.3.14.2 Writing and Reading the DEC

The content of the DEC can be read or written using the **mf spr** and **mt spr** instructions, both of which are supervisor-level when they refer to the DEC. Using a simplified mnemonic for the **mt spr** instruction, the DEC may be written from GPR **rA** with the following:

```
mtdec rA
```

Using a simplified mnemonic for the **mf spr** instruction, the DEC may be read into GPR **rA** with the following:

```
mfdec rA
```

2.3.15 Data Address Breakpoint Register (DABR)

The optional data address breakpoint facility is controlled by an optional SPR, the DABR. The DABR is a 64-bit register in 64-bit implementations and a 32-bit register in 32-bit implementations. The data address breakpoint facility is optional to the PowerPC architecture. However, if the data address breakpoint facility is implemented, it is recommended, but not required, that it be implemented as described in this section.

The data address breakpoint facility provides a means to detect accesses to a designated double word. The address comparison is done on an effective address, and it applies to data accesses only. It does not apply to instruction fetches.

The DABR is shown in Figure 2-31.

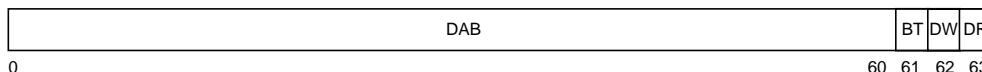

Figure 2-31. Data Address Breakpoint Register (DABR)

Table 2-20 describes the fields in the DABR.

Table 2-20. DABR—Bit Settings

Bits		Name	Description
64 Bit	32 Bit		
0–60	0–28	DAB	Data address breakpoint
61	29	BT	Breakpoint translation enable
62	30	DW	Data write enable
63	31	DR	Data read enable

A data address breakpoint match is detected for a load or store instruction if the three following conditions are met for any byte accessed:

- EA[0–60] = DABR[DAB]
- MSR[DR] = DABR[BT]
- The instruction is a store and DABR[DW] = 1, or the instruction is a load and DABR[DR] = 1.

Even if the above conditions are satisfied, it is undefined whether a match occurs in the following cases:

- A store string instruction (**stwx.** or **stdcx.**) in which the store is not performed
- A load or store string instruction (**lswx** or **stswx**) with a zero length
- A **dcbz**, **dcbz**, **eciwx**, or **ecowx** instruction. For the purpose of determining whether a match occurs, **eciwx** is treated as a load, and **dcbz**, **dcba**, and **ecowx** are treated as stores.

The cache management instructions other than **dcbz** and **dcba** never cause a match. If **dcbz** or **dcba** causes a match, some or all of the target memory locations may have been updated.

A match generates a DSI exception. Note that in 32-bit mode of a 64-bit implementation, the high-order 32 bits of the EA are treated as zero for the purpose of detecting a match. Refer to Section 6.4.3, “DSI Exception (0x00300),” for more information on the data address breakpoint facility.

2.3.16 External Access Register (EAR)

The EAR is an optional 32-bit SPR that controls access to the external control facility and identifies the target device for external control operations. The external control facility provides a means for user-level instructions to communicate with special external devices. The EAR is shown in Figure 2-32.

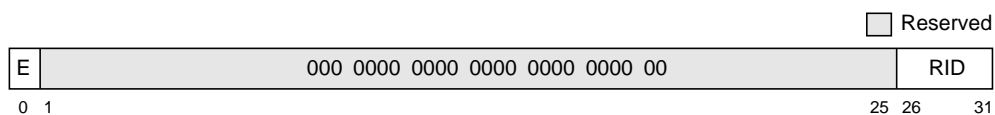

Figure 2-32. External Access Register (EAR)

The high-order bits of the resource ID (RID) field beyond the width of the RID supported by a particular implementation are treated as reserved bits.

The EAR register is provided to support the External Control In Word Indexed (**eciwx**) and External Control Out Word Indexed (**ecowx**) instructions, which are described in Chapter 8, “Instruction Set.” Although access to the EAR is supervisor-level, the operating system can determine which tasks are allowed to issue external access instructions and when they are allowed to do so. The bit settings for the EAR are described in Table 2-21. Interpretation of

the physical address transmitted by the **eciwx** and **ecowx** instructions and the 32-bit value transmitted by the **ecowx** instruction is not prescribed by the PowerPC OEA but is determined by the target device. The data access of **eciwx** and **ecowx** is performed as though the memory access mode bits (WIMG) were 0101.

For example, if the external control facility is used to support a graphics adapter, the **ecowx** instruction could be used to send the translated physical address of a buffer containing graphics data to the graphics device. The **eciwx** instruction could be used to load status information from the graphics adapter.

Table 2-21. External Access Register (EAR) Bit Settings

Bit	Name	Description
0	E	Enable bit 1 Enabled 0 Disabled If this bit is set, the eciwx and ecowx instructions can perform the specified external operation. If the bit is cleared, an eciwx or ecowx instruction causes a DSI exception.
1–25	—	Reserved
26–31	RID	Resource ID

This register can also be accessed by using the **mtspr** and **mfspir** instructions. Synchronization requirements for the EAR are shown in Table 2-22 and Table 2-23.

2.3.17 Processor Identification Register (PIR)

The PIR register is used to differentiate between individual processors in a multiprocessor environment. Note that the PIR is an optional register in the PowerPC architecture and may be implemented differently (or not at all) in the design of each processor. The user's manual of a specific processor will describe the functionality of the PIR, if it is implemented in that processor.

2.3.18 Synchronization Requirements for Special Registers and for Lookaside Buffers

Changing the value in certain system registers, and invalidating SLB and TLB entries, can cause alteration of the context in which data addresses and instruction addresses are interpreted, and in which instructions are executed. An instruction that alters the context in which data addresses or instruction addresses are interpreted, or in which instructions are executed, is called a context-altering instruction. The context synchronization required for context-altering instructions is shown in Table 2-22 for data access and Table 2-23 for instruction fetch and execution.

A context-synchronizing exception (that is, any exception except nonrecoverable system reset or nonrecoverable machine check) can be used instead of a context-synchronizing instruction. In the tables, if no software synchronization is required before (after) a context-

altering instruction, the synchronizing instruction before (after) the context-altering instruction should be interpreted as meaning the context-altering instruction itself.

A synchronizing instruction before the context-altering instruction ensures that all instructions up to and including that synchronizing instruction are fetched and executed in the context that existed before the alteration. A synchronizing instruction after the context-altering instruction ensures that all instructions after that synchronizing instruction are fetched and executed in the context established by the alteration. Instructions after the first synchronizing instruction, up to and including the second synchronizing instruction, may be fetched or executed in either context.

If a sequence of instructions contains context-altering instructions and contains no instructions that are affected by any of the context alterations, no software synchronization is required within the sequence.

Note that some instructions that occur naturally in the program, such as the **rfid** (or **rfi**) at the end of an exception handler, provide the required synchronization.

No software synchronization is required before altering the MSR (except when altering the MSR[POW] or MSR[LE] bits; see Table 2-22 and Table 2-23), because **mtmsrd** (or **mtmsr**) is execution synchronizing. No software synchronization is required before most of the other alterations shown in Table 2-23, because all instructions before the context-altering instruction are fetched and decoded before the context-altering instruction is executed (the processor must determine whether any of the preceding instructions are context synchronizing).

Table 2-22 provides information on data access synchronization requirements.

Table 2-22. Data Access Synchronization

Instruction/Event	Required Prior	Required After
Exception ¹	None	None
rfid (or rfi) ¹	None	None
sc ¹	None	None
Trap ¹	None	None
mtmsrd (SF)	None	Context-synchronizing instruction
mtmsrd (or mtmsr) (ILE)	None	None
mtmsrd (or mtmsr) (PR)	None	Context-synchronizing instruction
mtmsrd (or mtmsr) (ME) ²	None	Context-synchronizing instruction
mtmsrd (or mtmsr) (DR)	None	Context-synchronizing instruction
mtmsrd (or mtmsr) (LE) ³	—	—
mtsr [or mtsrin]	Context-synchronizing instruction	Context-synchronizing instruction
mtspr (ASR)	Context-synchronizing instruction	Context-synchronizing instruction

Table 2-22. Data Access Synchronization (Continued)

Instruction/Event	Required Prior	Required After
mtspr (SDR1) ^{4, 5}	sync	Context-synchronizing instruction
mtspr (DBAT)	Context-synchronizing instruction	Context-synchronizing instruction
mtspr (DABR) ⁶	—	—
mtspr (EAR)	Context-synchronizing instruction	Context-synchronizing instruction
slbie ⁷	Context-synchronizing instruction	Context-synchronizing instruction or sync
slbia ⁷	Context-synchronizing instruction	Context-synchronizing instruction or sync
tlbie ^{7, 8}	Context-synchronizing instruction	Context-synchronizing instruction or sync
tlbia ^{7, 8}	Context-synchronizing instruction	Context-synchronizing instruction or sync

Notes:

- ¹ Synchronization requirements for changing the power conserving mode are implementation-dependent.
- ² A context synchronizing instruction is required after modification of the MSR[ME] bit to ensure that the modification takes effect for subsequent machine check exceptions, which may not be recoverable and therefore may not be context synchronizing.
- ³ Synchronization requirements for changing from one endian mode to the other are implementation-dependent.
- ⁴ SDR1 must not be altered when MSR[DR] = 1 or MSR[IR] = 1; if it is, the results are undefined.
- ⁵ A **sync** instruction is required before the **mtspr** instruction because SDR1 identifies the page table and thereby the location of the referenced and changed (R and C) bits. To ensure that R and C bits are updated in the correct page table, SDR1 must not be altered until all R and C bit updates due to instructions before the **mtspr** have completed. A **sync** instruction guarantees this synchronization of R and C bit updates, while neither a context synchronizing operation nor the instruction fetching mechanism does so.
- ⁶ Synchronization requirements for changing the DABR are implementation-dependent.
- ⁷ For data accesses, the context synchronizing instruction before the **slbie**, **slbia**, **tlbie**, or **tlbia** instruction ensures that all memory accesses, due to preceding instructions, have completed to a point at which they have reported all exceptions that may be caused. The context synchronizing instruction after the **slbie**, **slbia**, **tlbie**, or **tlbia** ensures that subsequent memory accesses will not use the SLB or TLB entry(s) being invalidated. It does not ensure that all memory accesses previously translated by the SLB or TLB entry(s) being invalidated have completed with respect to memory or, for **tlbie** or **tlbia**, that R and C bit updates associated with those memory accesses have completed; if these completions must be ensured, the **slbie**, **slbia**, **tlbie**, or **tlbia** must be followed by a **sync** instruction rather than by a context synchronizing instruction.
- ⁸ Multiprocessor systems have other requirements to synchronize TLB invalidate.

For information on instruction access synchronization requirements, see Table 2-23.

Table 2-23. Instruction Access Synchronization

Instruction/Event	Required Prior	Required After
Exception ¹	None	None
rfd [or rff] ¹	None	None
sc ¹	None	None

Table 2-23. Instruction Access Synchronization (Continued)

Instruction/Event	Required Prior	Required After
Trap ¹	None	None
mtmsrd (SF) ²	None	Context-synchronizing instruction
mtmsrd (or mtmsr) (POW) ¹	—	—
mtmsrd (or mtmsr) (ILE)	None	None
mtmsrd (or mtmsr) (EE) ³	None	None
mtmsrd (or mtmsr) (PR)	None	Context-synchronizing instruction
mtmsrd (or mtmsr) (FP)	None	Context-synchronizing instruction
mtmsrd (or mtmsr) (ME) ⁴	None	Context-synchronizing instruction
mtmsrd (or mtmsr) (FE0, FE1)	None	Context-synchronizing instruction
mtmsrd (or mtmsr) (SE, BE)	None	Context-synchronizing instruction
mtmsrd (or mtmsr) (IP)	None	None
mtmsrd (or mtmsr) (IR) ⁵	None	Context-synchronizing instruction
mtmsrd (or mtmsr) (RI)	None	None
mtmsrd (or mtmsr) (LE) ⁶	—	—
mtsr [or mtsrin] ⁵	None	Context-synchronizing instruction
mtspr (ASR) ⁵	None	Context-synchronizing instruction
mtspr (SDR1) ^{7, 8}	sync	Context-synchronizing instruction
mtspr (IBAT) ⁵	None	Context-synchronizing instruction
mtspr (DEC) ⁹	None	None
slbie ¹⁰	None	Context-synchronizing instruction or sync
slbia ¹⁰	None	Context-synchronizing instruction or sync
tlbie ^{10, 11}	None	Context-synchronizing instruction or sync
tlbia ^{10, 11}	None	Context-synchronizing instruction or sync

Notes:

- ¹ Synchronization requirements for changing the power conserving mode are implementation-dependent.
- ² The alteration must not cause an implicit branch in effective address space. The **mtmsrd** (SF) instruction and all subsequent instructions, up to and including the next context-synchronizing instruction, must have effective addresses that are less than 2³².
- ³ The effect of altering the EE bit is immediate as follows:
 - If an **mtmsrd** (or **mtmsr**) sets the EE bit to 0, neither an external interrupt nor a decremter exception can occur after the instruction is executed.
 - If an **mtmsrd** (or **mtmsr**) sets the EE bit to 1 when an external interrupt, decremter exception, or higher priority exception exists, the corresponding exception occurs immediately after the **mtmsrd** (or **mtmsr**) is executed, and before the next instruction is executed in the program that set MSR[EE].
- ⁴ A context synchronizing instruction is required after modification of the MSR[ME] bit to ensure that the modification takes effect for subsequent machine check exceptions, which may not be recoverable and therefore may not be context synchronizing.

- ⁵ The alteration must not cause an implicit branch in physical address space. The physical address of the context-altering instruction and of each subsequent instruction, up to and including the next context synchronizing instruction, must be independent of whether the alteration has taken effect.
- ⁶ Synchronization requirements for changing from one endian mode to the other are implementation-dependent.
- ⁷ SDR1 must not be altered when MSR[DR] = 1 or MSR[IR] = 1; if it is, the results are undefined.
- ⁸ A **sync** instruction is required before the **mtspr** instruction because SDR1 identifies the page table and thereby the location of the referenced and changed (R and C) bits. To ensure that R and C bits are updated in the correct page table, SDR1 must not be altered until all R and C bit updates due to instructions before the **mtspr** have completed. A **sync** instruction guarantees this synchronization of R and C bit updates, while neither a context synchronizing operation nor the instruction fetching mechanism does so.
- ⁹ The elapsed time between the content of the decremter becoming negative and the signaling of the decremter exception is not defined.
- ¹⁰ For data accesses, the context synchronizing instruction before the **slbie**, **slbia**, **tlbie**, or **tlbia** instruction ensures that all memory accesses, due to preceding instructions, have completed to a point at which they have reported all exceptions that may be caused. The context synchronizing instruction after the **slbie**, **slbia**, **tlbie**, or **tlbia** ensures that subsequent memory accesses will not use the SLB or TLB entry(s) being invalidated. It does not ensure that all memory accesses previously translated by the SLB or TLB entry(s) being invalidated have completed with respect to memory or, for **tlbie** or **tlbia**, that R and C bit updates associated with those memory accesses have completed; if these completions must be ensured, the **slbie**, **slbia**, **tlbie**, or **tlbia** must be followed by a **sync** instruction rather than by a context synchronizing instruction.
- ¹¹ Multiprocessor systems have other requirements to synchronize TLB invalidate.

Chapter 3

Operand Conventions

This chapter describes the operand conventions as they are represented in two levels of the PowerPC architecture—user instruction set architecture (UIISA) and virtual environment architecture (VEA). Detailed descriptions are provided of conventions used for storing values in registers and memory, accessing PowerPC registers, and representing data in these registers in both big- and little-endian modes. Additionally, the floating-point data formats and exception conditions are described. Refer to Appendix D, “Floating-Point Models,” for more information on the implementation of the IEEE floating-point execution models.

3.1 Data Organization in Memory and Data Transfers U

In a PowerPC microprocessor-based system, bytes in memory are numbered consecutively starting with 0. Each number is the address of the corresponding byte. Memory operands may be bytes, half words, words, or double words, or, for the load and store multiple and the load and store string instructions, a sequence of bytes or words. The address of a memory operand is the address of its first byte (that is, of its lowest-numbered byte). Operand length is implicit for each instruction.

The following sections describe the concepts of alignment and byte ordering of data, and their significance to the PowerPC architecture.

3.1.1 Aligned and Misaligned Accesses

The operand of a single-register memory access instruction has a natural alignment boundary equal to the operand length. In other words, the natural address of an operand is an integral multiple of the operand length. A memory operand is said to be aligned if it is aligned at its natural boundary; otherwise it is misaligned. Instructions are always four bytes long and word-aligned.

Operands for single-register memory access instructions have the characteristics shown in Table 3-1. (Although not permitted as memory operands, quad words are shown because quad-word alignment is desirable for certain memory operands.)

Table 3-1. Memory Operand Alignment

Operand	Length	Aligned Addr(60–63)
Byte	8 bits	xxxx
Half word	2 bytes	xxx0
Word	4 bytes	xx00
Double word	8 bytes	x000
Quad word	16 bytes	0000

Note: An x in an address bit position indicates that the bit can be 0 or 1 independent of the state of other bits in the address.

The concept of alignment is also applied more generally to data in memory. For example, a 12-byte data item is said to be word-aligned if its address is a multiple of four.

Some instructions require their memory operands to have certain alignment. In addition, alignment may affect performance. For single-register memory access instructions, the best performance is obtained when memory operands are aligned.

3.1.2 Byte Ordering

If individual data items were indivisible, the concept of byte ordering would be unnecessary. The order of bits or groups of bits within the smallest addressable unit of memory is irrelevant, because nothing can be observed about such order. Order matters only when scalars, which the processor and programmer regard as indivisible quantities, can be made up of more than one addressable unit of memory.

For PowerPC processors, the smallest addressable memory unit is the byte (8 bits), and scalars are composed of one or more sequential bytes. When a 32-bit scalar is moved from a register to memory, it occupies four consecutive bytes in memory, and a decision must be made regarding the order of these bytes in these four addresses.

Although the choice of byte ordering is arbitrary, only two orderings are practical—big-endian and little-endian. The PowerPC architecture supports both big- and little-endian byte ordering. The default byte ordering is big-endian.

3.1.2.1 Big-Endian Byte Ordering

For big-endian scalars, the most-significant byte (MSB) is stored at the lowest (or starting) address while the least-significant byte (LSB) is stored at the highest (or ending) address. This is called big-endian because the big end of the scalar comes first in memory.

3.1.2.2 Little-Endian Byte Ordering

For little-endian scalars, the least-significant byte is stored at the lowest (or starting) address while the most-significant byte is stored at the highest (or ending) address. This is called little-endian because the little end of the scalar comes first in memory.

3.1.3 Structure Mapping Examples

Figure 3-1 shows a C programming example that contains an assortment of scalars and one array of characters (a string). The value presumed to be in each structure element is shown in hexadecimal in the comments (except for the character array, which is represented by a sequence of characters, each enclosed in single quote marks).

```
struct {
    int     a;      /* 0x1112_1314          word      */
    double  b;      /* 0x2122_2324_2526_2728 double word */
    char *  c;      /* 0x3132_3334          word      */
    char    d[7];   /* 'L','M','N','O','P','Q','R' array of bytes */
    short   e;      /* 0x5152              half word */
    int     f;      /* 0x6162_6364          word      */
} s;
```

Figure 3-1. C Program Example—Data Structure S

The data structure *S* is used throughout this section to demonstrate how the bytes that comprise each element (*a*, *b*, *c*, *d*, *e*, and *f*) are mapped into memory.

3.1.3.1 Big-Endian Mapping

The big-endian mapping of the structure, *S*, is shown in Figure 3-2. Addresses are shown in hexadecimal below each byte. The content of each byte, as shown in the preceding C programming example, is shown in hexadecimal and, for the character array, as characters enclosed in single quote marks. Note that the most-significant byte of each scalar is at the lowest address.

Contents	11	12	13	14	(x)	(x)	(x)	(x)
Address	00	01	02	03	04	05	06	07
Contents	21	22	23	24	25	26	27	28
Address	08	09	0A	0B	0C	0D	0E	0F
Contents	31	32	33	34	'L'	'M'	'N'	'O'
Address	10	11	12	13	14	15	16	17
Contents	'P'	'Q'	'R'	(x)	51	52	(x)	(x)
Address	18	19	1A	1B	1C	1D	1E	1F
Contents	61	62	63	64	(x)	(x)	(x)	(x)
Address	20	21	22	23	24	25	26	27

Figure 3-2. Big-Endian Mapping of Structure S

The structure mapping introduces padding (skipped bytes indicated by (x) in Figure 3-18) in the map in order to align the scalars on their proper boundaries—four bytes between elements *a* and *b*, one byte between elements *d* and *e*, and two bytes between elements *e* and *f*. Note that the padding is dependent on the compiler; it is not a function of the architecture.

3.1.3.2 Little-Endian Mapping

Figure 3-3 shows the structure, *S*, using little-endian mapping. Note that the least-significant byte of each scalar is at the lowest address.

Contents	14	13	12	11	(x)	(x)	(x)	(x)
Address	00	01	02	03	04	05	06	07
Contents	28	27	26	25	24	23	22	21
Address	08	09	0A	0B	0C	0D	0E	0F
Contents	34	33	32	31	'L'	'M'	'N'	'O'
Address	10	11	12	13	14	15	16	17
Contents	'P'	'Q'	'R'	(x)	52	51	(x)	(x)
Address	18	19	1A	1B	1C	1D	1E	1F
Contents	64	63	62	61	(x)	(x)	(x)	(x)
Address	20	21	22	23	24	25	26	27

Figure 3-3. Little-Endian Mapping of Structure *S*

Figure 3-3 shows the sequence of double words laid out with addresses increasing from left to right. Programmers familiar with little-endian byte ordering may be more accustomed to viewing double words laid out with addresses increasing from right to left, as shown in Figure 3-4. This allows the little-endian programmer to view each scalar in its natural byte order of MSB to LSB. However, to demonstrate how the PowerPC architecture provides both big- and little-endian support, this section uses the convention of showing addresses increasing from left to right, as in Figure 3-3.

Contents	(x)	(x)	(x)	(x)	11	12	13	14
Address	07	06	05	04	03	02	01	00

Contents	21	22	23	24	25	26	27	28
Address	0F	0E	0D	0C	0B	0A	09	08

Contents	'O'	'N'	'M'	'L'	31	32	33	34
Address	17	16	15	14	13	12	11	10

Contents	(x)	(x)	51	52	(x)	'R'	'Q'	'P'
Address	1F	1E	1D	1C	1B	1A	19	18

Contents	(x)	(x)	(x)	(x)	61	62	63	64
Address	27	26	25	24	23	22	21	20

Figure 3-4. Little-Endian Mapping of Structure S—Alternate View

3.1.4 PowerPC Byte Ordering

The PowerPC architecture supports both big- and little-endian byte ordering. The default byte ordering is big-endian. However, the code sequence used to switch from big- to little-endian mode may differ among processors.

The PowerPC architecture defines two bits in the MSR for specifying byte ordering—LE (little-endian mode) and ILE (exception little-endian mode). The LE bit specifies the endian mode in which the processor is currently operating and ILE specifies the mode to be used when an exception handler is invoked. That is, when an exception occurs, the ILE bit (as set for the interrupted process) is copied into MSR[LE] to select the endian mode for the context established by the exception. For both bits, a value of 0 specifies big-endian mode and a value of 1 specifies little-endian mode.

The PowerPC architecture also provides load and store instructions that reverse byte ordering. These instructions have the effect of loading and storing data in the endian mode opposite from that which the processor is operating. See Section 4.2.3.4, “Integer Load and Store with Byte-Reverse Instructions,” for more information on these instructions.

3.1.4.1 Aligned Scalars in Little-Endian Mode

Chapter 4, “Addressing Modes and Instruction Set Summary,” describes the effective address calculation for the load and store instructions. For processors in little-endian mode, the effective address is modified before being used to access memory. The three low-order address bits of the effective address are exclusive-ORed (XOR) with a three-bit value that depends on the length of the operand (1, 2, 4, or 8 bytes), as shown in Table 3-2. This address modification is called ‘munging’. Note that although the process is described in the

architecture, the actual term ‘munging’ is not defined or used in the specification. However, the term is commonly used to describe the effective address modifications necessary for converting big-endian addressed data to little-endian addressed data.

Table 3-2. EA Modifications

Data Width (Bytes)	EA Modification
8	No change
4	XOR with 0b100
2	XOR with 0b110
1	XOR with 0b111

The munged physical address is passed to the cache or to main memory, and the specified width of the data is transferred (in big-endian order—that is, MSB at the lowest address, LSB at the highest address) between a GPR or FPR and the addressed memory locations (as modified).

Munging makes it appear to the processor that individual aligned scalars are stored as little-endian, when in fact they are stored in big-endian order, but at different byte addresses within double words. Only the address is modified, not the byte order.

Taking into account the preceding description of munging, in little-endian mode, structure *S* is placed in memory as shown in Figure 3-5.

Contents	(x)	(x)	(x)	(x)	11	12	13	14
Address	00	01	02	03	04	05	06	07
Contents	21	22	23	24	25	26	27	28
Address	08	09	0A	0B	0C	0D	0E	0F
Contents	'O'	'N'	'M'	'L'	31	32	33	34
Address	10	11	12	13	14	15	16	17
Contents	(x)	(x)	51	52	(x)	'R'	'Q'	'P'
Address	18	19	1A	1B	1C	1D	1E	1F
Contents	(x)	(x)	(x)	(x)	61	62	63	64
Address	20	21	22	23	24	25	26	27

Figure 3-5. Munged Little-Endian Structure *S* as Seen by the Memory Subsystem

Note that the mapping shown in Figure 3-5 is not a true little-endian mapping of the structure *S*. However, because the processor munges the address when accessing memory, the physical structure *S* shown in Figure 3-5 appears to the processor as the structure *S* shown in Figure 3-6.

Contents	14	13	12	11				
Address	00	01	02	03	04	05	06	07
Contents	28	27	26	25	24	23	22	21
Address	08	09	0A	0B	0C	0D	0E	0F
Contents	34	33	32	31	'L'	'M'	'N'	'O'
Address	10	11	12	13	14	15	16	17
Contents	'P'	'Q'	'R'		52	51		
Address	18	19	1A	1B	1C	1D	1E	1F
Contents	64	63	62	61				
Address	20	21	22	23	24	25	26	27

Figure 3-6. Munged Little-Endian Structure *S* as Seen by Processor

Note that as seen by the program executing in the processor, the mapping for the structure *S* (Figure 3-6) is identical to the little-endian mapping shown in Figure 3-3. However, from outside of the processor, the addresses of the bytes making up the structure *S* are as shown in Figure 3-5. These addresses match neither the big-endian mapping of Figure 3-2 nor the true little-endian mapping of Figure 3-3. This must be taken into account when performing I/O operations in little-endian mode; this is discussed in Section 3.1.4.5, “PowerPC Input/Output Data Transfer Addressing in Little-Endian Mode.”

3.1.4.2 Misaligned Scalars in Little-Endian Mode

Performing an XOR operation on the low-order bits of the address works only if the scalar is aligned on a boundary equal to a multiple of its length. Figure 3-7 shows a true little-endian mapping of the four-byte word 0x1112_1314, stored at address 05.

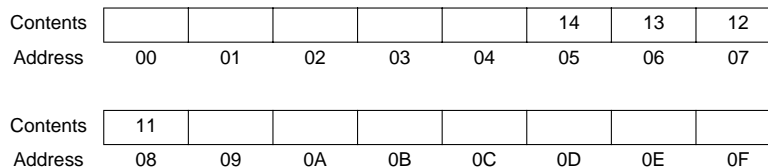

Figure 3-7. True Little-Endian Mapping, Word Stored at Address 05

For the true little-endian example in Figure 3-7, the least-significant byte (0x14) is stored at address 0x05, the next byte (0x13) is stored at address 0x06, the third byte (0x12) is stored at address 0x07, and the most-significant byte (0x11) is stored at address 0x08.

When a PowerPC processor, in little-endian mode, issues a single-register load or store instruction with a misaligned effective address, it may take an alignment exception. In this case, a single-register load or store instruction means any of the integer load/store, load/store with byte-reverse, memory synchronization (excluding **sync**), or floating-point load/store (including **stfiwx**) instructions. PowerPC processors in little-endian mode are not required to invoke an alignment exception when such a misaligned access is attempted. The processor may handle some or all such accesses without taking an alignment exception.

The PowerPC architecture requires that half words, words, and double words be placed in memory such that the little-endian address of the lowest-order byte is the effective address computed by the load or store instruction; the little-endian address of the next-lowest-order byte is one greater, and so on. However, because PowerPC processors in little-endian mode munge the effective address, the order of the bytes of a misaligned scalar must be as if they were accessed one at a time.

Using the same example as shown in Figure 3-7, when the least-significant byte (0x14) is stored to address 0x05, the address is XORed with 0b111 to become 0x02. When the next byte (0x13) is stored to address 0x06, the address is XORed with 0b111 to become 0x01. When the third byte (0x12) is stored to address 0x07, the address is XORed with 0b111 to become 0x00. Finally, when the most-significant byte (0x11) is stored to address 0x08, the address is XORed with 0b111 to become 0x0F. Figure 3-8 shows the misaligned word, stored by a little-endian program, as seen by the memory subsystem.

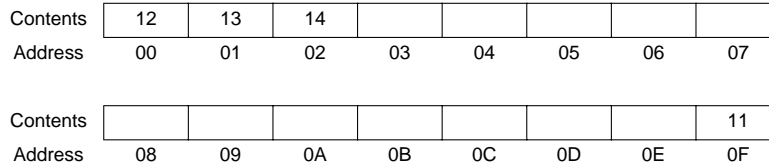

Figure 3-8. Word Stored at Little-Endian Address 05 as Seen by the Memory Subsystem

Note that the misaligned word in this example spans two double words. The two parts of the misaligned word are not contiguous as seen by the memory system. An implementation may support some but not all misaligned little-endian accesses. For example, a misaligned little-endian access that is contained within a double word may be supported, while one that spans double words may cause an alignment exception.

3.1.4.3 Nonscalars

The PowerPC architecture has two types of instructions that handle nonscalars (multiple instances of scalars):

- Load and store multiple instructions
- Load and store string instructions

Because these instructions typically operate on more than one word-length scalar, munging cannot be used. These types of instructions cause alignment exception conditions when the processor is executing in little-endian mode. Although string accesses are not supported, they are inherently byte-based operations, and can be broken into a series of word-aligned accesses.

3.1.4.4 PowerPC Instruction Addressing in Little-Endian Mode

Each PowerPC instruction occupies an aligned word of memory. PowerPC processors fetch and execute instructions as if the current instruction address is incremented by four for each sequential instruction. When operating in little-endian mode, the instruction address is munged as described in Section 3.1.4.1, “Aligned Scalars in Little-Endian Mode,” for fetching word-length scalars; that is, the instruction address is XORed with 0b100. A program is thus an array of little-endian words with each word fetched and executed in order (not including branches).

All instruction addresses visible to an executing program are the effective addresses that are computed by that program, or, in the case of the exception handlers, effective addresses that were or could have been computed by the interrupted program. These effective addresses are independent of the endian mode. Examples for little-endian mode include the following:

- An instruction address placed in the link register by branch and link operation, or an instruction address saved in an SPR when an exception is taken, is the address that a program executing in little-endian mode would use to access the instruction as a word of data using a load instruction.
- An offset in a relative branch instruction reflects the difference between the addresses of the branch and target instructions, where the addresses used are those that a program executing in little-endian mode would use to access the instructions as data words using a load instruction.
- A target address in an absolute branch instruction is the address that a program executing in little-endian mode would use to access the target instruction as a word of data using a load instruction.
- The memory locations that contain the first set of instructions executed by each kind of exception handler must be set in a manner consistent with the endian mode in which the exception handler is invoked. Thus, if the exception handler is to be invoked in little-endian mode, the first set of instructions comprising each kind of exception handler must appear in memory with the instructions within each double word reversed from the order in which they are to be executed.

3.1.4.5 PowerPC Input/Output Data Transfer Addressing in Little-Endian Mode

For a PowerPC system running in big-endian mode, both the processor and the memory subsystem recognize the same byte as byte 0. However, this is not true for a PowerPC system running in little-endian mode because of the munged address bits when the processor accesses memory.

For I/O transfers in little-endian mode to transfer bytes properly, they must be performed as if the bytes transferred were accessed one at a time, using the little-endian address modification appropriate for the single-byte transfers (that is, the lowest order address bits must be XORed with 0b111). This does not mean that I/O operations in little-endian PowerPC systems must be performed using only one-byte-wide transfers. Data transfers can be as wide as desired, but the order of the bytes within double words must be as if they were fetched or stored one at a time. That is, for a true little-endian I/O device, the system must provide a mechanism to munge and unmunge the addresses and reverse the bytes within a double word (MSB to LSB).

In earlier processors, I/O operations can also be performed with certain devices by storing to or loading from addresses that are associated with the devices (this is referred to as direct-store interface operations). However, the direct-store facility is being phased out of the architecture and will not likely be supported in future devices. Care must be taken with such operations when defining the addresses to be used because these addresses are subjected to munging as described in Section 3.1.4.1, “Aligned Scalars in Little-Endian Mode.” A load or store that maps to a control register on an external device may require the bytes of the value transferred to be reversed. If this reversal is required, the load and store with byte-reverse instructions may be used. See Section 4.2.3.4, “Integer Load and Store with Byte-Reverse Instructions,” for more information on these instructions.

3.2 Effect of Operand Placement on Performance—VEA

- ∇ The PowerPC VEA states that the placement (location and alignment) of operands in memory affects the relative performance of memory accesses. The best performance is guaranteed if memory operands are aligned on natural boundaries. For more information on memory access ordering and atomicity, refer to Section 5.1, “The Virtual Environment.”

3.2.1 Summary of Performance Effects

To obtain the best performance across the widest range of PowerPC processor implementations, the programmer should assume the performance model described in Table 3-3 and Table 3-4 with respect to the placement of memory operands.

The performance of accesses varies depending on the following:

- Operand size
- Operand alignment
- Endian mode (big-endian or little-endian)
- Crossing no boundary
- Crossing a cache block boundary
- Crossing a page boundary
- Crossing a BAT boundary
- Crossing a segment boundary

Table 3-3 applies when the processor is in big-endian mode.

Table 3-3. Performance Effects of Memory Operand Placement, Big-Endian Mode

Operand		Boundary Crossing			
Size	Byte Alignment	None	Cache Block	Page	BAT/Segment
Integer					
8 byte	8 4 <4	Optimal Good Poor	— Good Poor	— Poor Poor	— Poor Poor
4 byte	4 <4	Optimal Good	— Good	— Poor	— Poor
2 byte	2 <2	Optimal Good	— Good	— Poor	— Poor
1 byte	1	Optimal	—	—	—
lmw, stmw	4	Good	Good	Good ¹	Poor
String	—	Good	Good	Poor	Poor
Floating Point					
8 byte	8 4 <4	Optimal Good Poor	— Good Poor	— Poor Poor	— Poor Poor
4 byte	4 <4	Optimal Poor	— Poor	— Poor	— Poor

Note: ¹ Note that crossing a page boundary where the memory/cache access attributes of the two pages differ is equivalent to crossing a segment boundary, and thus has poor performance.

Table 3-4 applies when the processor is in little-endian mode.

Table 3-4. Performance Effects of Memory Operand Placement, Little-Endian Mode

Operand		Boundary Crossing			
Size	Byte Alignment	None	Cache Block	Page	BAT/Segment
Integer					
8 byte	8 <8	Optimal Poor	— Poor	— Poor	— Poor
4 byte	4 <4	Optimal Poor	— Poor	— Poor	— Poor
2 byte	2 <2	Optimal Poor	— Poor	— Poor	— Poor
1 byte	1	Optimal	—	—	—
Floating Point		None	Cache Block	Page	BAT/Segment
8 byte	8 <8	Optimal Poor	— Poor	— Poor	— Poor
4 byte	4 <4	Optimal Poor	— Poor	— Poor	— Poor

The load/store multiple and the load/store string instructions are supported only in big-endian mode. The load/store multiple instructions are defined by the PowerPC architecture to operate only on aligned operands. The load/store string instructions have no alignment requirements.

3.2.2 Instruction Restart

If a memory access crosses a page, BAT, or segment boundary, a number of conditions could abort the execution of the instruction after part of the access has been performed. For example, this may occur when a program attempts to access a page it has not previously accessed or when the processor must check for a possible change in the memory/cache access attributes when an access crosses a page boundary. When this occurs, the processor or the operating system may restart the instruction. If the instruction is restarted, some bytes at that location may be loaded from or stored to the target location a second time.

The following rules apply to memory accesses with regard to restarting the instruction:

- Aligned accesses—A single-register instruction that accesses an aligned operand is never restarted (that is, it is not partially executed).
- Misaligned accesses—A single-register instruction that accesses a misaligned operand may be restarted if the access crosses a page, BAT, or segment boundary, or if the processor is in little-endian mode.
- Load/store multiple, load/store string instructions—These instructions may be restarted if, in accessing the locations specified by the instruction, a page, BAT, or segment boundary is crossed.

The programmer should assume that any misaligned access in a segment might be restarted. When the processor is in big-endian mode, software can ensure that misaligned accesses are not restarted by placing the misaligned data in BAT areas, as BAT areas have no internal protection boundaries. Refer to Section 7.4, “Block Address Translation,” for more information on BAT areas.

3.3 Floating-Point Execution Models—UI5A

There are two kinds of floating-point instructions defined for the PowerPC architecture: computational and noncomputational. The computational instructions consist of those operations defined by the IEEE-754 standard for 64- and 32-bit arithmetic (those that perform addition, subtraction, multiplication, division, extracting the square root, rounding conversion, comparison, and combinations of these) and the multiply-add and reciprocal estimate instructions defined by the architecture. The noncomputational floating-point instructions consist of the floating-point load, store, and move instructions. While both the computational and noncomputational instructions are considered to be floating-point instructions governed by the MSR[FP] bit (that allows floating-point instructions to be executed), only the computational instructions are considered floating-point operations throughout this chapter.

The IEEE standard requires that single-precision arithmetic be provided for single-precision operands. The standard permits double-precision arithmetic instructions to have either (or both) single-precision or double-precision operands, but states that single-precision arithmetic instructions should not accept double-precision operands. The guidelines are as follows:

- Double-precision arithmetic instructions may have single-precision operands but always produce double-precision results.
- Single-precision arithmetic instructions require all operands to be single-precision and always produce single-precision results.

For arithmetic instructions, conversion from double- to single-precision must be done explicitly by software, while conversion from single- to double-precision is done implicitly by the processor.

All PowerPC implementations provide the equivalent of the following execution models to ensure that identical results are obtained. The definition of the arithmetic instructions for infinities, denormalized numbers, and NaNs follow conventions described in the following sections. Appendix D, “Floating-Point Models,” has additional detailed information on the execution models for IEEE operations as well as the other floating-point instructions.

Although the double-precision format specifies an 11-bit exponent, exponent arithmetic uses two additional bit positions to avoid potential transient overflow conditions. An extra bit is required when denormalized double-precision numbers are prenormalized. A second

bit is required to permit computation of the adjusted exponent value in the following examples when the corresponding exception enable bit is 1 (exceptions are referred to as interrupts in the architecture specification):

- Underflow during multiplication using a denormalized operand
- Overflow during division using a denormalized divisor

3.3.1 Floating-Point Data Format

The PowerPC UISA defines the representation of a floating-point value in two different binary, fixed-length formats. The format is a 32-bit format for a single-precision floating-point value or a 64-bit format for a double-precision floating-point value. The single-precision format may be used for data in memory. The double-precision format can be used for data in memory or in floating-point registers (FPRs).

The lengths of the exponent and the fraction fields differ between these two formats. The layout of the single-precision format is shown in Figure 3-9; the layout of the double-precision format is shown in Figure 3-10.

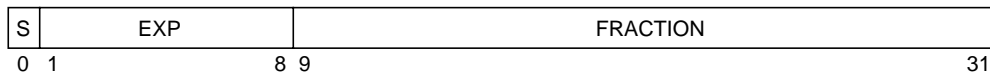

Figure 3-9. Floating-Point Single-Precision Format

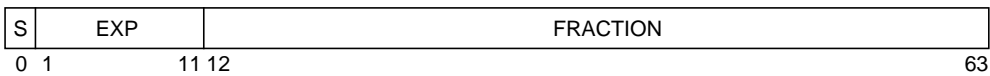

Figure 3-10. Floating-Point Double-Precision Format

Values in floating-point format consist of three fields:

- S (sign bit)
- EXP (exponent + bias)
- FRACTION (fraction)

If only a portion of a floating-point data item in memory is accessed, as with a load or store instruction for a byte or half word (or word in the case of floating-point double-precision format), the value affected depends on whether the PowerPC system is using big- or little-endian byte ordering, which is described in Section 3.1.2, “Byte Ordering.” Big-endian mode is the default.

For numeric values, the significand consists of a leading implied bit concatenated on the right with the FRACTION. This leading implied bit is a 1 for normalized numbers and a 0 for denormalized numbers and is the first bit to the left of the binary point. Values representable within the two floating-point formats can be specified by the parameters listed in Table 3-5.

Table 3-5. IEEE Floating-Point Fields

Parameter	Single-Precision	Double-Precision
Exponent bias	+127	+1023
Maximum exponent (unbiased)	+127	+1023
Minimum exponent (unbiased)	-126	-1022
Format width	32 bits	64 bits
Sign width	1 bit	1 bit
Exponent width	8 bits	11 bits
Fraction width	23 bits	52 bits
Significand width	24 bits	53 bits

The true value of the exponent can be determined by subtracting 127 for single-precision numbers and 1023 for double-precision numbers. This is shown in Table 3-6. Note that two exponent values are reserved to represent special-case values. Setting all bits indicates that the value is an infinity or NaN and clearing all bits indicates that the number is either zero or denormalized.

Table 3-6. Biased Exponent Format

Biased Exponent (Binary)	Single-Precision (Unbiased)	Double-Precision (Unbiased)
11....11	Reserved for infinities and NaNs	
11....10	+127	+1023
11....01	+126	+1022
.	.	.
.	.	.
.	.	.
10....00	1	1
01....11	0	0
01....10	-1	-1
.	.	.
.	.	.

Table 3-6. Biased Exponent Format (Continued)

Biased Exponent (Binary)	Single-Precision (Unbiased)	Double-Precision (Unbiased)
.	.	.
00.01	-126	-1022
00.00	Reserved for zeros and denormalized numbers	

3.3.1.1 Value Representation

The PowerPC UISA defines numerical and nonnumerical values representable within single- and double-precision formats. The numerical values are approximations to the real numbers and include the normalized numbers, denormalized numbers, and zero values. The nonnumerical values representable are the positive and negative infinities and the NaNs. The positive and negative infinities are adjoined to the real numbers but are not numbers themselves, and the standard rules of arithmetic do not hold when they appear in an operation. They are related to the real numbers by order alone. It is possible, however, to define restricted operations among numbers and infinities as defined below. The relative location on the real number line for each of the defined numerical entities is shown in Figure 3-11. Tiny values include denormalized numbers and all numbers that are too small to be represented for a particular precision format; they do not include ± 0 .

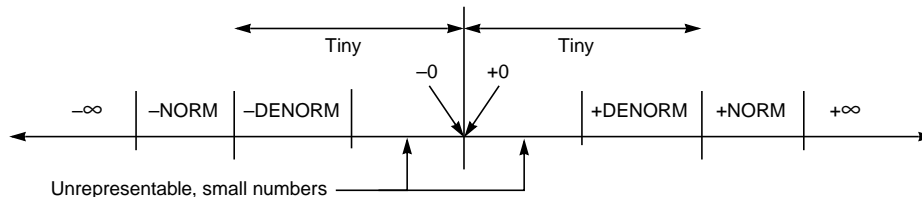

Figure 3-11. Approximation to Real Numbers

The positive and negative NaNs are encodings that convey diagnostic information such as the representation of uninitialized variables and are not related to the numbers, $\pm\infty$, or each other by order or value.

Table 3-7 describes each of the floating-point formats.

Table 3-7. Recognized Floating-Point Numbers

Sign Bit	Biased Exponent	Implied Bit	Fraction	Value
0	Maximum	x	Nonzero	NaN
0	Maximum	x	Zero	+Infinity
0	0 < Exponent < Maximum	1	x	+Normalized
0	0	0	Nonzero	+Denormalized
0	0	x	Zero	+0

Table 3-7. Recognized Floating-Point Numbers (Continued)

Sign Bit	Biased Exponent	Implied Bit	Fraction	Value
1	0	x	Zero	-0
1	0	0	Nonzero	-Denormalized
1	0 < Exponent < Maximum	1	x	-Normalized
1	Maximum	x	Zero	-Infinity
1	Maximum	x	Nonzero	NaN

The following sections describe floating-point values defined in the architecture.

3.3.1.2 Binary Floating-Point Numbers

Binary floating-point numbers are machine-representable values used to approximate real numbers. Three categories of numbers are supported—normalized numbers, denormalized numbers, and zero values.

3.3.1.3 Normalized Numbers (\pm NORM)

The values for normalized numbers have a biased exponent value in the range:

- 1–254 in single-precision format
- 1–2046 in double-precision format

The implied unit bit is one. Normalized numbers are interpreted as follows:

$$\text{NORM} = (-1)^s \times 2^E \times (1.\text{fraction})$$

The variable (s) is the sign, (E) is the unbiased exponent, and (1.fraction) is the significant composed of a leading unit bit (implied bit) and a fractional part. The format for normalized numbers is shown in Figure 3-12.

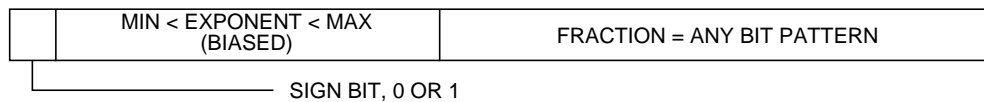

Figure 3-12. Format for Normalized Numbers

The ranges covered by the magnitude (M) of a normalized floating-point number are approximated in the following decimal representation:

Single-precision format:

$$1.2 \times 10^{-38} \leq M \leq 3.4 \times 10^{38}$$

Double-precision format:

$$2.2 \times 10^{-308} \leq M \leq 1.8 \times 10^{308}$$

3.3.1.4 Zero Values (± 0)

Zero values have a biased exponent value of zero and fraction of zero. This is shown in Figure 3-13. Zeros can have a positive or negative sign. The sign of zero is ignored by comparison operations (that is, comparison regards +0 as equal to -0). Arithmetic with zero results is always exact and does not signal any exception, except when an exception occurs due to the invalid operations as described in Section 3.3.6.1.1, “Invalid Operation Exception Condition.” Rounding a zero result only affects the sign (± 0).

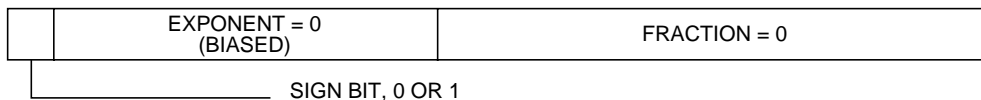

Figure 3-13. Format for Zero Numbers

3.3.1.5 Denormalized Numbers (\pm DENORM)

Denormalized numbers have a biased exponent value of zero and a nonzero fraction. The format for denormalized numbers is shown in Figure 3-14.

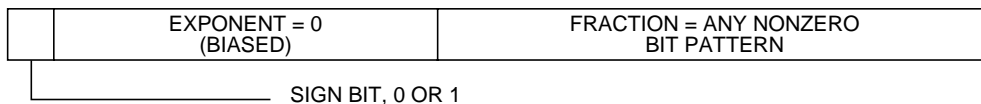

Figure 3-14. Format for Denormalized Numbers

Denormalized numbers are nonzero numbers smaller in magnitude than the normalized numbers. They are values in which the implied unit bit is zero. Denormalized numbers are interpreted as follows:

$$\text{DENORM} = (-1)^s \times 2^{\text{Emin}} \times (0.\text{fraction})$$

The value E_{min} is the minimum unbiased exponent value for a normalized number (-126 for single-precision, -1022 for double-precision).

3.3.1.6 Infinities ($\pm\infty$)

These are values that have the maximum biased exponent value of 255 in the single-precision format, 2047 in the double-precision format, and a zero fraction value. They are used to approximate values greater in magnitude than the maximum normalized value. Infinity arithmetic is defined as the limiting case of real arithmetic, with restricted operations defined among numbers and infinities. Infinities and the real numbers can be related by ordering in the affine sense:

$$-\infty < \text{every finite number} < +\infty$$

The format for infinities is shown in Figure 3-15.



Figure 3-15. Format for Positive and Negative Infinities

Arithmetic using infinite numbers is always exact and does not signal any exception, except when an exception occurs due to the invalid operations as described in Section 3.3.6.1.1, “Invalid Operation Exception Condition.”

3.3.1.7 Not a Numbers (NaNs)

NaNs have the maximum biased exponent value and a nonzero fraction. The format for NaNs is shown in Figure 3-16. The sign bit of NaN does not show an algebraic sign; rather, it is simply another bit in the NaN. If the highest-order bit of the fraction field is a zero, the NaN is a signaling NaN; otherwise it is a quiet NaN (QNaN).



Figure 3-16. Format for NaNs

Signaling NaNs signal exceptions when they are specified as arithmetic operands.

Quiet NaNs represent the results of certain invalid operations, such as attempts to perform arithmetic operations on infinities or NaNs, when the invalid operation exception is disabled (FPSCR[VE] = 0). Quiet NaNs propagate through all operations, except floating-point round to single-precision, ordered comparison, and conversion to integer operations, and signal exceptions only for ordered comparison and conversion to integer operations. Specific encodings in QNaNs can thus be preserved through a sequence of operations and used to convey diagnostic information to help identify results from invalid operations.

When a QNaN results from an operation because an operand is a NaN or because a QNaN is generated due to a disabled invalid operation exception, the following rule is applied to determine the QNaN to be stored as the result:

```

If (frA) is a NaN
  Then frD ← (frA)
Else if (frB) is a NaN
  Then if instruction is frsp
    Then frD ← (frB)[0-34]|(29)0
    Else frD ← (frB)
  Else if (frC) is a NaN
    Then frD ← (frC)
  Else if generated QNaN
    Then frD ← generated QNaN

```

If the operand specified by **frA** is a NaN, that NaN is stored as the result. Otherwise, if the operand specified by **frB** is a NaN (if the instruction specifies an **frB** operand), that NaN is stored as the result, with the low-order 29 bits cleared. Otherwise, if the operand specified by **frC** is a NaN (if the instruction specifies an **frC** operand), that NaN is stored as the result. Otherwise, if a QNaN is generated by a disabled invalid operation exception, that QNaN is stored as the result. If a QNaN is to be generated as a result, the QNaN generated has a sign bit of zero, an exponent field of all ones, and a highest-order fraction bit of one with all other fraction bits zero. An instruction that generates a QNaN as the result of a disabled invalid operation generates this QNaN. This is shown in Figure 3-17.

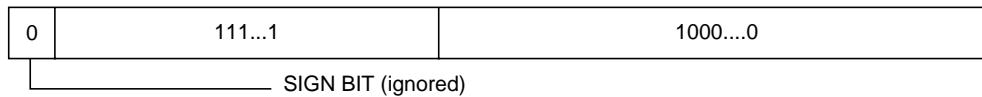

Figure 3-17. Representation of Generated QNaN

3.3.2 Sign of Result

The following rules govern the sign of the result of an arithmetic operation, when the operation does not yield an exception. These rules apply even when the operands or results are ± 0 or $\pm\infty$:

- The sign of the result of an addition operation is the sign of the source operand having the larger absolute value. If both operands have the same sign, the sign of the result of an addition operation is the same as the sign of the operands. The sign of the result of the subtraction operation, $x - y$, is the same as the sign of the result of the addition operation, $x + (-y)$.
- When the sum of two operands with opposite sign, or the difference of two operands with the same sign, is exactly zero, the sign of the result is positive in all rounding modes except round toward negative infinity ($-\infty$), in which case the sign is negative.
- The sign of the result of a multiplication or division operation is the XOR of the signs of the source operands.

- The sign of the result of a round to single-precision or convert to/from integer operation is the sign of the source operand.
- The sign of the result of a square root or reciprocal square root estimate operation is always positive, except that the square root of -0 is -0 and the reciprocal square root of -0 is $-\infty$.

For multiply-add instructions, these rules are applied first to the multiplication operation and then to the addition or subtraction operation (one of the source operands to the addition or subtraction operation is the result of the multiplication operation).

3.3.3 Normalization and Denormalization

The intermediate result of an arithmetic or Floating Round to Single-Precision (**frsp x**) instruction may require normalization and/or denormalization. When an intermediate result consists of a sign bit, an exponent, and a nonzero significand with a zero leading bit, the result must be normalized (and rounded) before being stored to the target.

A number is normalized by shifting its significand left and decrementing its exponent by one for each bit shifted until the leading significand bit becomes one. The guard and round bits are also shifted, with zeros shifted into the round bit; see Section D.1, “Execution Model for IEEE Operations,” for information about the guard and round bits. During normalization, the exponent is regarded as if its range were unlimited.

If an intermediate result has a nonzero significand and an exponent that is smaller than the minimum value that can be represented in the format specified for the result, this value is referred to as ‘tiny’ and the stored result is determined by the rules described in Section 3.3.6.2.2, “Underflow Exception Condition.” These rules may involve denormalization. The sign of the number does not change.

An exponent can become tiny in either of the following circumstances:

- As the result of an arithmetic or Floating Round to Single-Precision (**frsp x**) instruction or
- As the result of decrementing the exponent in the process of normalization.

Normalization is the process of coercing the leading significand bit to be a 1 while denormalization is the process of coercing the exponent into the target format’s range. In denormalization, the significand is shifted to the right while the exponent is incremented for each bit shifted until the exponent equals the format’s minimum value. The result is then rounded. If any significand bits are lost due to the rounding of the shifted value, the result is considered inexact. The sign of the number does not change.

3.3.4 Data Handling and Precision

There are specific instructions for moving floating-point data between the FPRs and memory. For double-precision format data, the data is not altered during the move. For single-precision data, the format is converted to double-precision format when data is loaded from memory into an FPR. A format conversion from double- to single-precision is performed when data from an FPR is stored as single-precision. These operations do not cause floating-point exceptions.

All floating-point arithmetic, move, and select instructions use floating-point double-precision format.

Floating-point single-precision formats are obtained by using the following four types of instructions:

- Load floating-point single-precision instructions—These instructions access a single-precision operand in single-precision format in memory, convert it to double-precision, and load it into an FPR. Floating-point exceptions do not occur during the load operation.
- Floating Round to Single-Precision (**frsp x**) instruction—The **frsp x** instruction rounds a double-precision operand to single-precision, checking the exponent for single-precision range and handling any exceptions according to respective enable bits in the FPSCR. The instruction places that operand into an FPR as a double-precision operand. For results produced by single-precision arithmetic instructions and by single-precision loads, this operation does not alter the value.
- Single-precision arithmetic instructions—These instructions take operands from the FPRs in double-precision format, perform the operation as if it produced an intermediate result correct to infinite precision and with unbounded range, and then force this intermediate result to fit in single-precision format. Status bits in the FPSCR and in the condition register are set to reflect the single-precision result. The result is then converted to double-precision format and placed into an FPR. The result falls within the range supported by the single-precision format.

Source operands for these instructions must be representable in single-precision format. Otherwise, the result placed into the target FPR and the setting of status bits in the FPSCR, and in the condition register if update mode is selected, are undefined.

- Store floating-point single-precision instructions—These instructions convert a double-precision operand to single-precision format and store that operand into memory. If the operand requires denormalization in order to fit in single-precision format, it is automatically denormalized prior to being stored. No exceptions are detected on the store operation (the value being stored is effectively assumed to be the result of an instruction of one of the preceding three types).

When the result of a Load Floating-Point Single (**lfs**), Floating Round to Single-Precision (**frsp x**), or single-precision arithmetic instruction is stored in an FPR, the low-order 29 fraction bits are zero. This is shown in Figure 3-18.

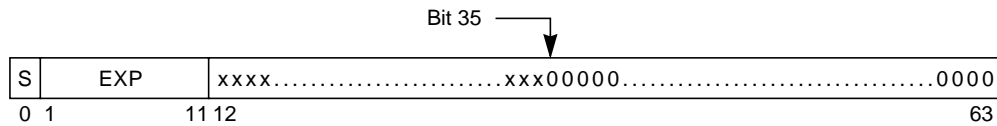

Figure 3-18. Single-Precision Representation in an FPR

The **frsp_x** instruction allows conversion from double- to single-precision with appropriate exception checking and rounding. This instruction should be used to convert double-precision floating-point values (produced by double-precision load and arithmetic instructions) to single-precision values before storing them into single-format memory elements or using them as operands for single-precision arithmetic instructions. Values produced by single-precision load and arithmetic instructions can be stored directly, or used directly as operands for single-precision arithmetic instructions, without being preceded by an **frsp_x** instruction.

A single-precision value can be used in double-precision arithmetic operations. The reverse is true only if the double-precision value can be represented in single-precision format. Some implementations may execute single-precision arithmetic instructions faster than double-precision arithmetic instructions. Therefore, if double-precision accuracy is not required, using single-precision data and instructions may speed operations in some implementations.

3.3.5 Rounding

All arithmetic, rounding, and conversion instructions defined by the PowerPC architecture (except the optional Floating Reciprocal Estimate Single (**fres_x**) and Floating Reciprocal Square Root Estimate (**frsqrte_x**) instructions) produce an intermediate result considered to be infinitely precise and with unbounded exponent range. This intermediate result is normalized or denormalized if required, and then rounded to the destination format. The final result is then placed into the target FPR in the double-precision format or in fixed-point format, depending on the instruction.

The IEEE-754 specification allows loss of accuracy to be defined as when the rounded result differs from the infinitely precise value with unbounded range (same as the definition of ‘inexact’). In the PowerPC architecture, this is the way loss of accuracy is detected.

Let *Z* be the intermediate arithmetic result (with infinite precision and unbounded range) or the operand of a conversion operation. If *Z* can be represented exactly in the target format, then the result in all rounding modes is exactly *Z*. If *Z* cannot be represented exactly in the target format, let *Z1* and *Z2* be the next larger and next smaller numbers representable in the target format that bound *Z*; then *Z1* or *Z2* can be used to approximate the result in the target format.

Figure 3-19 shows a graphical representation of Z, Z1, and Z2 in this case.

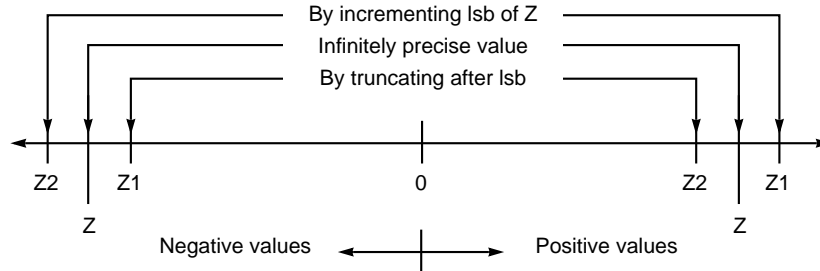

Figure 3-19. Relation of Z1 and Z2

Four rounding modes are available through the floating-point rounding control field (RN) in the FPSCR. See Section 2.1.4, “Floating-Point Status and Control Register (FPSCR).” These are encoded as follows in Table 3-8.

Table 3-8. FPSCR Bit Settings—RN Field

RN	Rounding Mode	Rules
00	Round to nearest	Choose the best approximation (Z1 or Z2). In case of a tie, choose the one that is even (least-significant bit 0).
01	Round toward zero	Choose the smaller in magnitude (Z1 or Z2).
10	Round toward +infinity	Choose Z1.
11	Round toward -infinity	Choose Z2.

See Section D.1, “Execution Model for IEEE Operations,” for a detailed explanation of rounding. Rounding occurs before an overflow condition is detected. This means that while an infinitely precise value with unbounded exponent range may be greater than the greatest representable value, the rounding mode may allow that value to be rounded to a representable value. In this case, no overflow condition occurs.

However, the underflow condition is tested before rounding. Therefore, if the value that is infinitely precise and with unbounded exponent range falls within the range of unrepresentable values, the underflow condition occurs. The results in these cases are defined in Section 3.3.6.2.2, “Underflow Exception Condition.” Figure 3-20 shows the selection of Z1 and Z2 for the four possible rounding modes that are provided by FPSCR[RN].

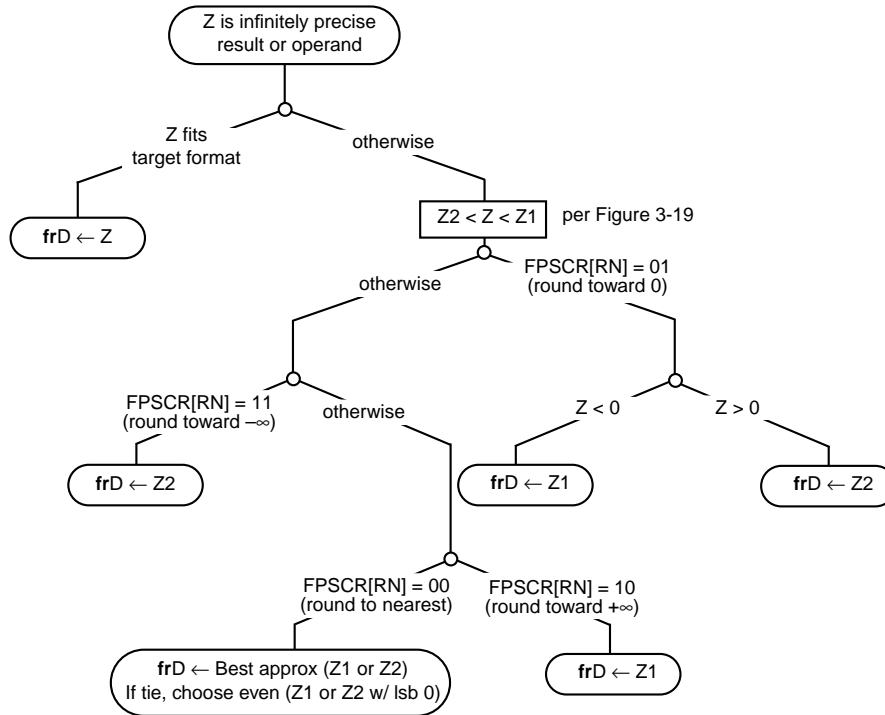

Figure 3-20. Selection of Z1 and Z2 for the Four Rounding Modes

All arithmetic, rounding, and conversion instructions affect FPSCR bits FR and FI, according to whether the rounded result is inexact (FI) and whether the fraction was incremented (FR) as shown in Figure 3-21. If the rounded result is inexact, FI is set and FR may be either set or cleared. If rounding does not change the result, both FR and FI are cleared. The optional **fresx** and **frsrtext** instructions set FI and FR to undefined values; other floating-point instructions do not alter FR and FI.

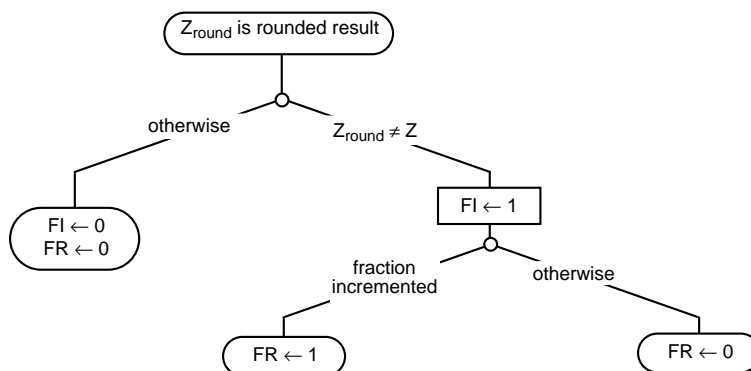

Figure 3-21. Rounding Flags in FPSCR

3.3.6 Floating-Point Program Exceptions

The computational instructions of the PowerPC architecture are the only instructions that can cause floating-point enabled exceptions (subsets of the program exception). In the processor, floating-point program exceptions are signaled by condition bits set in the floating-point status and control register (FPSCR) as described in this section and in Chapter 2, “PowerPC Register Set.” These bits correspond to those conditions identified as IEEE floating-point exceptions and can cause the system floating-point enabled exception error handler to be invoked. Handling for floating-point exceptions is described in Section 6.4.7, “Program Exception (0x00700).”

The FPSCR is shown in Figure 3-22.

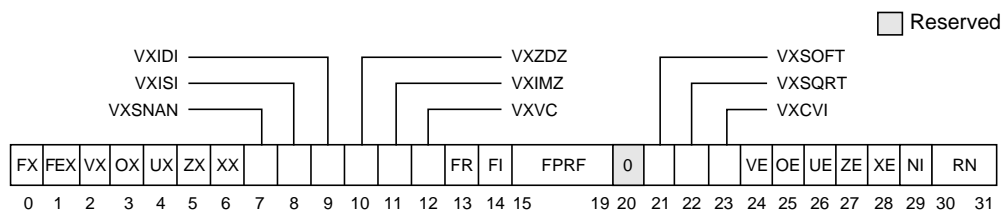

Figure 3-22. Floating-Point Status and Control Register (FPSCR)

A listing of FPSCR bit settings is shown in Table 3-9.

Table 3-9. FPSCR Bit Settings

Bit(s)	Name	Description
0	FX	Floating-point exception summary. Every floating-point instruction, except mtfsfi and mtfsf , implicitly sets FPSCR[FX] if that instruction causes any of the floating-point exception bits in the FPSCR to transition from 0 to 1. The mcrfs , mtfsfi , mtfsf , mtfsb0 , and mtfsb1 instructions can alter FPSCR[FX] explicitly. This is a sticky bit.
1	FEX	Floating-point enabled exception summary. This bit signals the occurrence of any of the enabled exception conditions. It is the logical OR of all the floating-point exception bits masked by their respective enable bits ($FEX = (VX \& VE) \wedge (OX \& OE) \wedge (UX \& UE) \wedge (ZX \& ZE) \wedge (XX \& XE)$). The mcrfs , mtfsf , mtfsfi , mtfsb0 , and mtfsb1 instructions cannot alter FPSCR[FEX] explicitly. This is not a sticky bit.
2	VX	Floating-point invalid operation exception summary. This bit signals the occurrence of any invalid operation exception. It is the logical OR of all of the invalid operation exception bits as described in Section 3.3.6.1.1, "Invalid Operation Exception Condition." The mcrfs , mtfsf , mtfsfi , mtfsb0 , and mtfsb1 instructions cannot alter FPSCR[VX] explicitly. This is not a sticky bit.
3	OX	Floating-point overflow exception. This is a sticky bit. See Section 3.3.6.2, "Overflow, Underflow, and Inexact Exception Conditions."
4	UX	Floating-point underflow exception. This is a sticky bit. See Section 3.3.6.2.2, "Underflow Exception Condition."
5	ZX	Floating-point zero divide exception. This is a sticky bit. See Section 3.3.6.1.2, "Zero Divide Exception Condition."
6	XX	Floating-point inexact exception. This is a sticky bit. See Section 3.3.6.2.3, "Inexact Exception Condition." FPSCR[XX] is the sticky version of FPSCR[F]. The following rules describe how FPSCR[XX] is set by a given instruction: <ul style="list-style-type: none"> • If the instruction affects FPSCR[F], the new value of FPSCR[XX] is obtained by logically ORing the old value of FPSCR[XX] with the new value of FPSCR[F]. • If the instruction does not affect FPSCR[F], the value of FPSCR[XX] is unchanged.
7	VXSNAN	Floating-point invalid operation exception for sNaN. This is a sticky bit. See Section 3.3.6.1.1, "Invalid Operation Exception Condition."
8	VXISI	Floating-point invalid operation exception for $\infty - \infty$. This is a sticky bit. See Section 3.3.6.1.1, "Invalid Operation Exception Condition."
9	VXIDI	Floating-point invalid operation exception for $\infty \div \infty$. This is a sticky bit. See Section 3.3.6.1.1, "Invalid Operation Exception Condition."
10	VXZDZ	Floating-point invalid operation exception for $0 \div 0$. This is a sticky bit. See Section 3.3.6.1.1, "Invalid Operation Exception Condition."
11	VXIMZ	Floating-point invalid operation exception for $\infty * 0$. This is a sticky bit. See Section 3.3.6.1.1, "Invalid Operation Exception Condition."
12	VXVC	Floating-point invalid operation exception for invalid compare. This is a sticky bit. See Section 3.3.6.1.1, "Invalid Operation Exception Condition."
13	FR	Floating-point fraction rounded. The last arithmetic, rounding, or conversion instruction incremented the fraction. See Section 3.3.5, "Rounding." This bit is not sticky.

Table 3-9. FPSCR Bit Settings (Continued)

Bit(s)	Name	Description
14	FI	Floating-point fraction inexact. The last arithmetic, rounding, or conversion instruction either produced an inexact result during rounding or caused a disabled overflow exception. See Section 3.3.5, "Rounding." This is not a sticky bit. For more information regarding the relationship between FPSCR[FI] and FPSCR[XX], see the description of the FPSCR[XX] bit.
15–19	FPRF	Floating-point result flags. For arithmetic, rounding, and conversion instructions the field is based on the result placed into the target register, except that if any portion of the result is undefined, the value placed here is undefined. 15 Floating-point result class descriptor (C). Arithmetic, rounding, and conversion instructions may set this bit with the FPCC bits to indicate the class of the result as shown in Table 3-10. 16–19 Floating-point condition code (FPCC). Floating-point compare instructions always set one of the FPCC bits to one and the other three FPCC bits to zero. Arithmetic, rounding, and conversion instructions may set the FPCC bits with the C bit to indicate the class of the result. Note that in this case the high-order three bits of the FPCC retain their relational significance indicating that the value is less than, greater than, or equal to zero. 16 Floating-point less than or negative (FL or <) 17 Floating-point greater than or positive (FG or >) 18 Floating-point equal or zero (FE or =) 19 Floating-point unordered or NaN (FU or ?) Note that these are not sticky bits.
20	—	Reserved
21	VXSOFT	Floating-point invalid operation exception for software request. This is a sticky bit. This bit can be altered only by the mcrfs , mtfsfi , mtfsf , mtfsb0 , or mtfsb1 instructions. For more detailed information, refer to Section 3.3.6.1.1, "Invalid Operation Exception Condition."
22	VXSQRT	Floating-point invalid operation exception for invalid square root. This is a sticky bit. For more detailed information, refer to Section 3.3.6.1.1, "Invalid Operation Exception Condition."
23	VXCVI	Floating-point invalid operation exception for invalid integer convert. This is a sticky bit. See Section 3.3.6.1.1, "Invalid Operation Exception Condition."
24	VE	Floating-point invalid operation exception enable. See Section 3.3.6.1.1, "Invalid Operation Exception Condition."
25	OE	IEEE floating-point overflow exception enable. See Section 3.3.6.2, "Overflow, Underflow, and Inexact Exception Conditions."
26	UE	IEEE floating-point underflow exception enable. See Section 3.3.6.2.2, "Underflow Exception Condition."
27	ZE	IEEE floating-point zero divide exception enable. See Section 3.3.6.1.2, "Zero Divide Exception Condition."
28	XE	Floating-point inexact exception enable. See Section 3.3.6.2.3, "Inexact Exception Condition."

Table 3-9. FPSCR Bit Settings (Continued)

Bit(s)	Name	Description
29	NI	Floating-point non-IEEE mode. If this bit is set, results need not conform with IEEE standards and the other FPSCR bits may have meanings other than those described here. If the bit is set and if all implementation-specific requirements are met and if an IEEE-conforming result of a floating-point operation would be a denormalized number, the result produced is zero (retaining the sign of the denormalized number). Any other effects associated with setting this bit are described in the user's manual for the implementation. Effects of the setting of this bit are implementation-dependent.
30–31	RN	Floating-point rounding control. See Section 3.3.5, "Rounding." 00 Round to nearest 01 Round toward zero 10 Round toward +infinity 11 Round toward –infinity

Table 3-10 illustrates the floating-point result flags used by PowerPC processors. The result flags correspond to FPSCR bits 15–19 (the FPRF field).

Table 3-10. Floating-Point Result Flags — FPSCR[FPRF]

Result Flags (Bits 15–19)					Result Value Class
C	<	>	=	?	
1	0	0	0	1	Quiet NaN
0	1	0	0	1	–Infinity
0	1	0	0	0	–Normalized number
1	1	0	0	0	–Denormalized number
1	0	0	1	0	–Zero
0	0	0	1	0	+Zero
1	0	1	0	0	+Denormalized number
0	0	1	0	0	+Normalized number
0	0	1	0	1	+Infinity

The following conditions that can cause program exceptions are detected by the processor. These conditions may occur during execution of computational floating-point instructions. The corresponding bits set in the FPSCR are indicated in parentheses:

- Invalid operation exception condition (VX)
 - SNaN condition (VXSNAN)
 - Infinity – infinity condition (VXISI)
 - Infinity ÷ infinity condition (VXIDI)
 - Zero ÷ zero condition (VXZDZ)
 - Infinity * zero condition (VXIMZ)

- Invalid compare condition (VXVC)
- Software request condition (VXSOFI)
- Invalid integer convert condition (VXCVI)
- Invalid square root condition (VXSQRT)

These exception conditions are described in Section 3.3.6.1.1, “Invalid Operation Exception Condition.”

- Zero divide exception condition (ZX). These exception conditions are described in Section 3.3.6.1.2, “Zero Divide Exception Condition.”
- Overflow Exception Condition (OX). These exception conditions are described in Section 3.3.6.2.1, “Overflow Exception Condition.”
- Underflow Exception Condition (UX). These exception conditions are described in Section 3.3.6.2.2, “Underflow Exception Condition.”
- Inexact Exception Condition (XX). These exception conditions are described in Section 3.3.6.2.3, “Inexact Exception Condition.”

Each floating-point exception condition and each category of invalid IEEE floating-point operation exception condition has a corresponding exception bit in the FPSCR which indicates the occurrence of that condition. Generally, the occurrence of an exception condition depends only on the instruction and its arguments (with one deviation, described below). When one or more exception conditions arise during the execution of an instruction, the way in which the instruction completes execution depends on the value of the IEEE floating-point enable bits in the FPSCR which govern those exception conditions. If no governing enable bit is set to 1, the instruction delivers a default result. Otherwise, specific condition bits and the FX bit in the FPSCR are set and instruction execution is completed by suppressing or delivering a result. Finally, after the instruction execution has completed, a nonzero FX bit in the FPSCR causes a program exception if either FE0 or FE1 is set in the MSR (invoking the system error handler). The values in the FPRs immediately after the occurrence of an enabled exception do not depend on the FE0 and FE1 bits.

The floating-point exception summary bit (FX) in the FPSCR is set by any floating-point instruction (except **mtfsfi** and **mtfsf**) that causes any of the exception bits in the FPSCR to change from 0 to 1, or by **mtfsfi**, **mtfsf**, and **mtfsb1** instructions that explicitly set one of these bits. FPSCR[FEX] is set when any of the exception condition bits is set and the exception is enabled (enable bit is one).

A single instruction may set more than one exception condition bit only in the following cases:

- The inexact exception condition bit (FPSCR[XX]) may be set with the overflow exception condition bit (FPSCR[OX]).
- The inexact exception condition bit (FPSCR[XX]) may be set with the underflow exception condition bit (FPSCR[UX]).

- The invalid IEEE floating-point operation exception condition bit (SNaN) may be set with invalid IEEE floating-point operation exception condition bit ($\infty*0$) (FPSCR[VXIMZ]) for multiply-add instructions.
- The invalid operation exception condition bit (SNaN) may be set with the invalid IEEE floating-point operation exception condition bit (invalid compare) (FPRSC[VXVC]) for compare ordered instructions.
- The invalid IEEE floating-point operation exception condition bit (SNaN) may be set with the invalid IEEE floating-point operation exception condition bit (invalid integer convert) (FPSCR[VXCVI]) for convert-to-integer instructions.

Instruction execution is suppressed for the following kinds of exception conditions, so that there is no possibility that one of the operands is lost:

- Enabled invalid IEEE floating-point operation
- Enabled zero divide

For the remaining kinds of exception conditions, a result is generated and written to the destination specified by the instruction causing the exception condition. The result may depend on whether the condition is enabled or disabled. The kinds of exception conditions that deliver a result are the following:

- Disabled invalid IEEE floating-point operation
- Disabled zero divide
- Disabled overflow
- Disabled underflow
- Disabled inexact
- Enabled overflow
- Enabled underflow
- Enabled inexact

Subsequent sections define each of the floating-point exception conditions and specify the action taken when they are detected.

The IEEE standard specifies the handling of exception conditions in terms of traps and trap handlers. In the PowerPC architecture, an FPSCR exception enable bit being set causes generation of the result value specified in the IEEE standard for the trap enabled case—the expectation is that the exception is detected by software, which will revise the result. An FPSCR exception enable bit of 0 causes generation of the default result value specified for the trap disabled (or no trap occurs or trap is not implemented) case—the expectation is that the exception will not be detected by software, which will simply use the default result. The result to be delivered in each case for each exception is described in the following sections.

The IEEE default behavior when an exception occurs, which is to generate a default value and not to notify software, is obtained by clearing all FPSCR exception enable bits and using ignore exceptions mode (see Table 3-11). In this case the system floating-point enabled exception error handler is not invoked, even if floating-point exceptions occur. If necessary, software can inspect the FPSCR exception bits to determine whether exceptions have occurred.

If the system error handler is to be invoked, the corresponding FPSCR exception enable bit must be set and a mode other than ignore exceptions mode must be used. In this case the system floating-point enabled exception error handler is invoked if an enabled floating-point exception condition occurs.

Whether and how the system floating-point enabled exception error handler is invoked if an enabled floating-point exception occurs is controlled by MSR bits FE0 and FE1 as shown in Table 3-11. (The system floating-point enabled exception error handler is never invoked if the appropriate floating-point exception is disabled.)

Table 3-11. MSR[FE0] and MSR[FE1] Bit Settings for FP Exceptions

FE0	FE1	Description
0	0	Ignore exceptions mode—Floating-point exceptions do not cause the program exception error handler to be invoked.
0	1	Imprecise nonrecoverable mode—When an exception occurs, the exception handler is invoked at some point at or beyond the instruction that caused the exception. It may not be possible to identify the excepting instruction or the data that caused the exception. Results from the excepting instruction may have been used by or affected subsequent instructions executed before the exception handler was invoked.
1	0	Imprecise recoverable mode— When an enabled exception occurs, the floating-point enabled exception handler is invoked at some point at or beyond the instruction that caused the exception. Sufficient information is provided to the exception handler that it can identify the excepting instruction and correct any faulty results. In this mode, no results caused by the excepting instruction have been used by or affected subsequent instructions that are executed before the exception handler is invoked.
1	1	Precise mode—The system floating-point enabled exception error handler is invoked precisely at the instruction that caused the enabled exception.

In precise mode, whenever the system floating-point enabled exception error handler is invoked, the architecture ensures that all instructions logically residing before the excepting instruction have completed and no instruction after the excepting instruction has been executed. In an imprecise mode, the instruction flow may not be interrupted at the point of the instruction that caused the exception. The instruction at which the system floating-point exception handler is invoked has not been executed unless it is the excepting instruction and the exception is not suppressed.

In either of the imprecise modes, an FPSCR instruction can be used to force the occurrence of any invocations of the floating-point enabled exception handler, due to instructions initiated before the FPSCR instruction. This forcing has no effect in ignore exceptions mode and is superfluous for precise mode.

Instead of using an FPSCR instruction, an execution synchronizing instruction or event can be used to force exceptions and set bits in the FPSCR; however, for the best performance across the widest range of implementations, an FPSCR instruction should be used to achieve these effects.

For the best performance across the widest range of implementations, the following guidelines should be considered:

- If IEEE default results are acceptable to the application, FE0 and FE1 should be cleared (ignore exceptions mode). All FPSCR exception enable bits should be cleared.
- If IEEE default results are unacceptable to the application, an imprecise mode should be used with the FPSCR enable bits set as needed.
- Ignore exceptions mode should not, in general, be used when any FPSCR exception enable bits are set.
- Precise mode may degrade performance in some implementations, perhaps substantially, and therefore should be used only for debugging and other specialized applications.

3.3.6.1 Invalid Operation and Zero Divide Exception Conditions

The flow diagram in Figure 3-23 shows the initial flow for checking floating-point exception conditions (invalid operation and divide by zero conditions). In any of these cases of floating-point exception conditions, if the FPSCR[FEX] bit is set (implicitly) and MSR[FE0–FE1] \neq 00, the processor takes a program exception (floating-point enabled exception type). Refer to Chapter 6, “Exceptions,” for more information on exception processing. The actions performed for each floating-point exception condition are described in greater detail in the following sections.

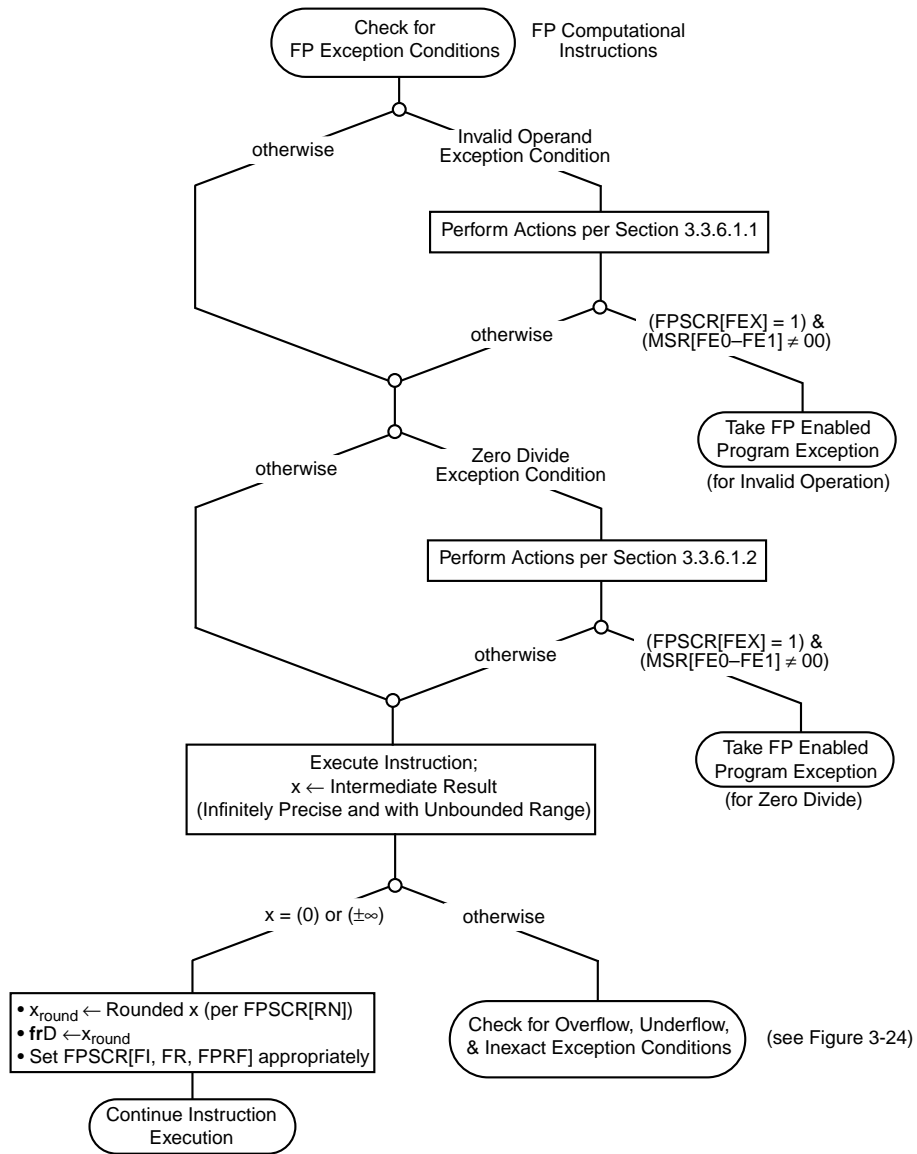

Figure 3-23. Initial Flow for Floating-Point Exception Conditions

3.3.6.1.1 Invalid Operation Exception Condition

An invalid operation exception occurs when an operand is invalid for the specified operation. The invalid operations are as follows:

- Any operation except load, store, move, select, or **mtfsf** on a signaling NaN (SNaN)
- For add or subtract operations, magnitude subtraction of infinities ($\infty - \infty$)
- Division of infinity by infinity ($\infty \div \infty$)
- Division of zero by zero ($0 \div 0$)
- Multiplication of infinity by zero ($\infty * 0$)
- Ordered comparison involving a NaN (invalid compare)
- Square root or reciprocal square root of a negative, nonzero number (invalid square root). Note that if the implementation does not support the optional floating-point square root or floating-point reciprocal square root estimate instructions, software can simulate the instruction and set the FPSCR[VXSQRT] bit to reflect the exception.
- Integer convert involving a number that is too large in magnitude to be represented in the target format, or involving an infinity or a NaN (invalid integer convert)

FPSCR[VXSOFT] allows software to cause an invalid operation exception for a condition that is not necessarily associated with the execution of a floating-point instruction. For example, it might be set by a program that computes a square root if the source operand is negative. This allows PowerPC instructions not implemented in hardware to be emulated.

Any time an invalid operation occurs or software explicitly requests the exception via FPSCR[VXSOFT], (regardless of the value of FPSCR[VE]), the following actions are taken:

- One or two invalid operation exception condition bits is set
 - FPSCR[VXSNAN] (if SNaN)
 - FPSCR[VXISI] (if $\infty - \infty$)
 - FPSCR[VXIDI] (if $\infty \div \infty$)
 - FPSCR[VXZDZ] (if $0 \div 0$)
 - FPSCR[VXIMZ] (if $\infty * 0$)
 - FPSCR[VXVC] (if invalid comparison)
 - FPSCR[VXSOFT] (if software request)
 - FPSCR[VXSQRT] (if invalid square root)
 - FPSCR[VXCVI] (if invalid integer convert)
- If the operation is a compare,
 - FPSCR[FR, FI, C] are unchanged
 - FPSCR[FPCC] is set to reflect unordered
- If software explicitly requests the exception,
 - FPSCR[FR, FI, FPRF] are as set by the **mtfsfi**, **mtfsf**, or **mtfsb1** instruction.

There are additional actions performed that depend on the value of FPSCR[VE]. These are described in Table 3-12.

Table 3-12. Additional Actions Performed for Invalid FP Operations

Invalid Operation	Result Category	Action Performed	
		FPSCR[VE] = 1	FPSCR[VE] = 0
Arithmetic or floating-point round to single	frD	Unchanged	QNaN
	FPSCR[FR, FI]	Cleared	Cleared
	FPSCR[FPRF]	Set for QNaN	Unchanged
Convert to 64-bit integer (positive number or $+\infty$)	frD[0–63]	Unchanged	Most positive 64-bit integer value
	FPSCR[FR, FI]	Cleared	Cleared
	FPSCR[FPRF]	Set for QNaN	Undefined
Convert to 64-bit integer (negative number, NaN, or $-\infty$)	frD[0–63]	Unchanged	Most negative 64-bit integer value
	FPSCR[FR, FI]	Cleared	Cleared
	FPSCR[FPRF]	Set for QNaN	Undefined
Convert to 32-bit integer (positive number or $+\infty$)	frD[0–31]	Unchanged	Undefined
	frD[32–63]	Unchanged	Most positive 32-bit integer value
	FPSCR[FR, FI]	Cleared	Cleared
	FPSCR[FPRF]	Set for QNaN	Undefined
Convert to 32-bit integer (negative number, NaN, or $-\infty$)	frD[0–31]	Unchanged	Undefined
	frD[32–63]	Unchanged	Most negative 32-bit integer value
	FPSCR[FR, FI]	Cleared	Cleared
	FPSCR[FPRF]	Set for QNaN	Undefined
All cases	FPSCR[FEX]	Implicitly set (causes exception)	Unchanged

3.3.6.1.2 Zero Divide Exception Condition

A zero divide exception condition occurs when a divide instruction is executed with a zero divisor value and a finite, nonzero dividend value or when an **fres** or **frsqrte** instruction is executed with a zero operand value. This exception condition indicates an exact infinite result from finite operands exception condition corresponding to a mathematical pole (divide or **fres**) or a branch point singularity (**frsqrte**).

When a zero divide condition occurs, the following actions are taken:

- Zero divide exception condition bit is set $\text{FPSCR}[\text{ZX}] = 1$.
- $\text{FPSCR}[\text{FR}, \text{FI}]$ are cleared.

Additional actions depend on the setting of the zero divide exception condition enable bit, $\text{FPSCR}[\text{ZE}]$, as described in Table 3-13.

Table 3-13. Additional Actions Performed for Zero Divide

Result Category	Action Performed	
	$\text{FPSCR}[\text{ZE}] = 1$	$\text{FPSCR}[\text{ZE}] = 0$
frD	Unchanged	$\pm\infty$ (sign determined by XOR of the signs of the operands)
$\text{FPSCR}[\text{FEX}]$	Implicitly set (causes exception)	Unchanged
$\text{FPSCR}[\text{FPRF}]$	Unchanged	Set to indicate $\pm\infty$

3.3.6.2 Overflow, Underflow, and Inexact Exception Conditions

As described earlier, the overflow, underflow, and inexact exception conditions are detected after the floating-point instruction has executed and an infinitely precise result with unbounded range has been computed. Figure 3-24 shows the flow for the detection of these conditions and is a continuation of Figure 3-23. As in the cases of invalid operation, or zero divide conditions, if the $\text{FPSCR}[\text{FEX}]$ bit is implicitly set as described in Table 3-9 and $\text{MSR}[\text{FE0-FE1}] \neq 00$, the processor takes a program exception (floating-point enabled exception type). Refer to Chapter 6, “Exceptions,” for more information on exception processing. The actions performed for each of these floating-point exception conditions (including the generated result) are described in greater detail in the following sections.

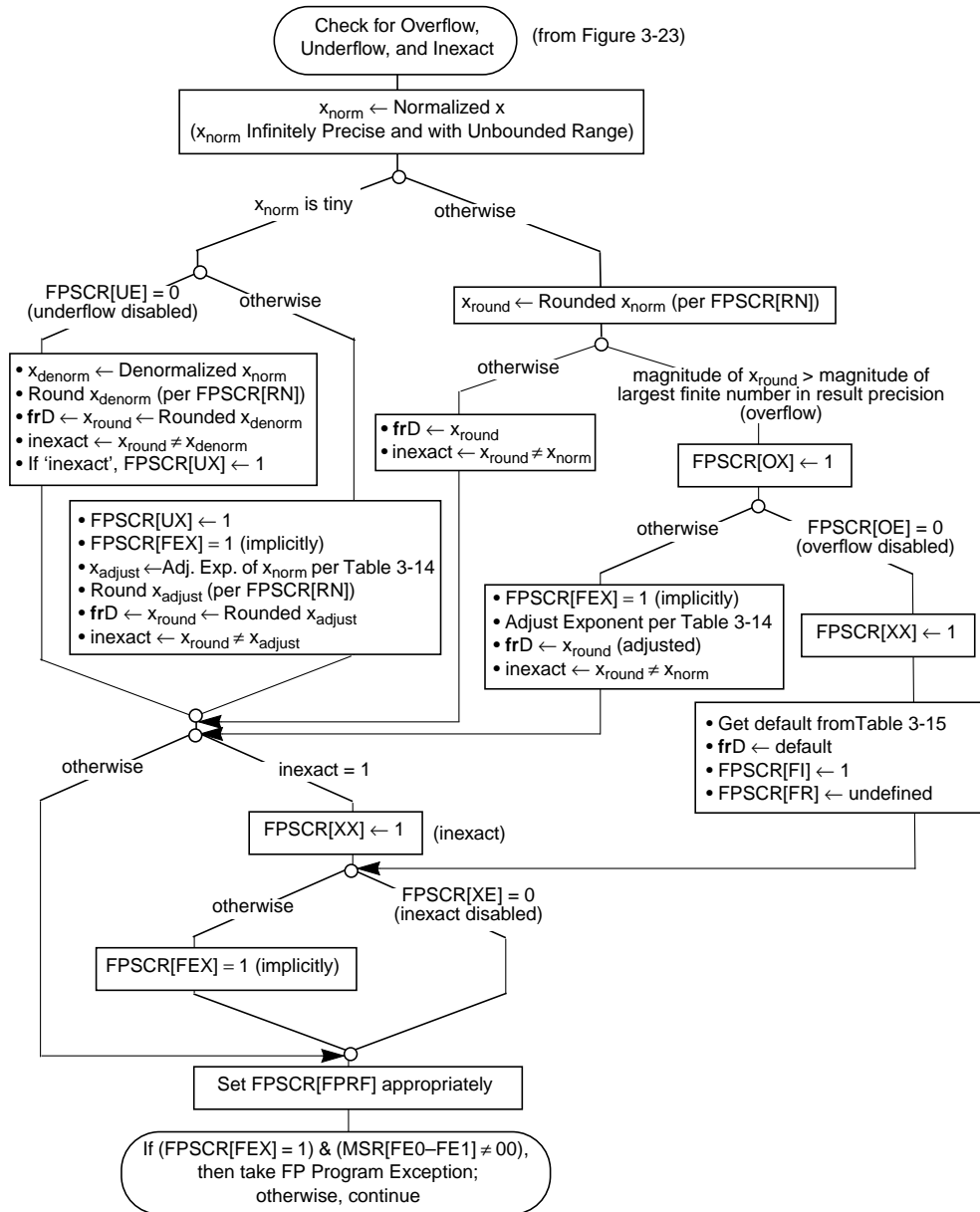

Figure 3-24. Checking of Remaining Floating-Point Exception Conditions

3.3.6.2.1 Overflow Exception Condition

Overflow occurs when the magnitude of what would have been the rounded result (had the exponent range been unbounded) is greater than the magnitude of the largest finite number of the specified result precision. Regardless of the setting of the overflow exception condition enable bit of the FPSCR, the following action is taken:

- The overflow exception condition bit is set $FPSCR[OX] = 1$.

Additional actions are taken that depend on the setting of the overflow exception condition enable bit of the FPSCR as described in Table 3-14.

Table 3-14. Additional Actions Performed for Overflow Exception Condition

Condition	Result Category	Action Performed	
		$FPSCR[OE] = 1$	$FPSCR[OE] = 0$
Double-precision arithmetic instructions	Exponent of normalized intermediate result	Adjusted by subtracting 1536	—
Single-precision arithmetic and frsp_x instruction	Exponent of normalized intermediate result	Adjusted by subtracting 192	—
All cases	frD	Rounded result (with adjusted exponent)	Default result per Table 3-15
	FPSCR[XX]	Set if rounded result differs from intermediate result	Set
	FPSCR[FEX]	Implicitly set (causes exception)	Unchanged
	FPSCR[FPRF]	Set to indicate \pm normal number	Set to indicate $\pm\infty$ or \pm normal number
	FPSCR[FI]	Reflects rounding	Set
	FPSCR[FR]	Reflects rounding	Undefined

When the overflow exception condition is disabled ($FPSCR[OE] = 0$) and an overflow condition occurs, the default result is determined by the rounding mode bit ($FPSCR[RN]$) and the sign of the intermediate result as shown in Table 3-15.

Table 3-15. Target Result for Overflow Exception Disabled Case

FPSCR[RN]	Sign of Intermediate Result	frD
Round to nearest	Positive	+Infinity
	Negative	-Infinity
Round toward zero	Positive	Format's largest finite positive number
	Negative	Format's most negative finite number
Round toward +infinity	Positive	+Infinity
	Negative	Format's most negative finite number
Round toward -infinity	Positive	Format's largest finite positive number
	Negative	-Infinity

3.3.6.2.2 Underflow Exception Condition

The underflow exception condition is defined separately for the enabled and disabled states:

- Enabled—Underflow occurs when the intermediate result is tiny.
- Disabled—Underflow occurs when the intermediate result is tiny and the rounded result is inexact.

In this context, the term ‘tiny’ refers to a floating-point value that is too small to be represented for a particular precision format.

As shown in Figure 3-24, a tiny result is detected before rounding, when a nonzero intermediate result value computed as though it had infinite precision and unbounded exponent range is less in magnitude than the smallest normalized number.

If the intermediate result is tiny and the underflow exception condition enable bit is cleared (FPSCR[UE] = 0), the intermediate result is denormalized (see Section 3.3.3, “Normalization and Denormalization”) and rounded (see Section 3.3.5, “Rounding”) before being stored in an FPR. In this case, if the rounding causes the delivered result value to differ from what would have been computed were both the exponent range and precision unbounded (the result is inexact), then underflow occurs and FPSCR[UX] is set.

The actions performed for underflow exception conditions are described in Table 3-16.

Table 3-16. Actions Performed for Underflow Conditions

Condition	Result Category	Action Performed	
		FPSCR[UE] = 1	FPSCR[UE] = 0
Double-precision arithmetic instructions	Exponent of normalized intermediate result	Adjusted by adding 1536	—
Single-precision arithmetic and frsp x instructions	Exponent of normalized intermediate result	Adjusted by adding 192	—
All cases	frD	Rounded result (with adjusted exponent)	Denormalized and rounded result
	FPSCR[XX]	Set if rounded result differs from intermediate result	Set if rounded result differs from intermediate result
	FPSCR[UX]	Set	Set only if tiny and inexact after denormalization and rounding
	FPSCR[FPRF]	Set to indicate \pm normalized number	Set to indicate \pm denormalized number or \pm zero
	FPSCR[FEX]	Implicitly set (causes exception)	Unchanged
	FPSCR[FI]	Reflects rounding	Reflects rounding
	FPSCR[FR]	Reflects rounding	Reflects rounding

Note that the FR and FI bits in the FPSCR allow the system floating-point enabled exception error handler, when invoked because of an underflow exception condition, to simulate a trap disabled environment. That is, the FR and FI bits allow the system floating-point enabled exception error handler to unround the result, thus allowing the result to be denormalized.

3.3.6.2.3 Inexact Exception Condition

The inexact exception condition occurs when one of two conditions occur during rounding:

- The rounded result differs from the intermediate result assuming the intermediate result exponent range and precision to be unbounded. (In the case of an enabled overflow or underflow condition, where the exponent of the rounded result is adjusted for those conditions, an inexact condition occurs only if the significand of the rounded result differs from that of the intermediate result.)
- The rounded result overflows and the overflow exception condition is disabled.

When an inexact exception condition occurs, the following actions are taken independently of the setting of the inexact exception condition enable bit of the FPSCR:

- Inexact exception condition bit in the FPSCR is set $FPSCR[XX] = 1$.
- The rounded or overflowed result is placed into the target FPR.
- $FPSCR[FPRF]$ is set to indicate the class and sign of the result.

In addition, if the inexact exception condition enable bit in the FPSCR ($FPSCR[XE]$) is set, and an inexact condition exists, then the $FPSCR[FEX]$ bit is implicitly set, causing the processor to take a floating-point enabled program exception.

In PowerPC implementations, running with inexact exception conditions enabled may have greater latency than enabling other types of floating-point exception conditions.

Chapter 4

Addressing Modes and Instruction Set Summary

This chapter describes instructions and addressing modes defined by the three levels of the PowerPC architecture—user instruction set architecture (UISA), virtual environment architecture (VEA), and operating environment architecture (OEA). These instructions are divided into the following functional categories:

- Integer instructions—These include arithmetic and logical instructions. For more information, see Section 4.2.1, “Integer Instructions.”
- Floating-point instructions—These include floating-point arithmetic instructions, as well as instructions that affect the floating-point status and control register (FPSCR). For more information, see Section 4.2.2, “Floating-Point Instructions.”
- Load and store instructions—These include integer and floating-point load and store instructions. For more information, see Section 4.2.3, “Load and Store Instructions.”
- Flow control instructions—These include branching instructions, condition register logical instructions, trap instructions, and other instructions that affect the instruction flow. For more information, see Section 4.2.4, “Branch and Flow Control Instructions.”
- Processor control instructions—These instructions are used for synchronizing memory accesses and managing of caches, TLBs, and the segment registers. For more information, see Section 4.2.5, “Processor Control Instructions—UISA,” Section 4.3.1, “Processor Control Instructions—VEA,” and Section 4.4.2, “Processor Control Instructions—OEA.”
- Memory synchronization instructions—These instructions control the order in which memory operations are completed with respect to asynchronous events, and the order in which memory operations are seen by other processors or memory access mechanisms. For more information, see Section 4.2.6, “Memory Synchronization Instructions—UISA,” and Section 4.3.2, “Memory Synchronization Instructions—VEA.”
- Memory control instructions—These include cache management instructions (user-level and supervisor-level), segment register manipulation instructions, and translation lookaside buffer management instructions. For more information, see Section 4.3.3, “Memory Control Instructions—VEA,” and Section 4.4.3, “Memory

Control Instructions—OEA.” (Note that user-level and supervisor-level are referred to as problem state and privileged state, respectively, in the architecture specification.)

- External control instructions—These instructions allow a user-level program to communicate with a special-purpose device. For more information, see Section 4.3.4, “External Control Instructions.”

This grouping of instructions does not necessarily indicate the execution unit that processes a particular instruction or group of instructions within a processor implementation.

- U Integer instructions operate on byte, half-word, word, and double-word (in 64-bit implementations) operands. Floating-point instructions operate on single-precision and double-precision floating-point operands. The PowerPC architecture uses instructions that are four bytes long and word-aligned. It provides for byte, half-word, word, and double-word (in 64-bit implementations) operand fetches and stores between memory and a set of 32 general-purpose registers (GPRs). It also provides for word and double-word operand fetches and stores between memory and a set of 32 floating-point registers (FPRs). The FPRs are 64 bits wide in all PowerPC implementations. The GPRs are 32 bits wide in 32-bit implementations and 64 bits wide in 64-bit implementations.

Arithmetic and logical instructions do not read or modify memory. To use the contents of a memory location in a computation and then modify the same or another memory location, the memory contents must be loaded into a register, modified, and then written to the target location using load and store instructions.

The description of each instruction includes the mnemonic and a formatted list of operands. PowerPC-compliant assemblers support the mnemonics and operand lists. To simplify assembly language programming, a set of simplified mnemonics (referred to as extended mnemonics in the architecture specification) and symbols is provided for some of the most frequently-used instructions; see Appendix F, “Simplified Mnemonics,” for a complete list of simplified mnemonics.

- U The instructions are organized by functional categories while maintaining the delineation of the three levels of the PowerPC architecture—UISA, VEA, and OEA; Section 4.2 discusses the UISA instructions, followed by Section 4.3 that discusses the VEA instructions and Section 4.4 that discusses the OEA instructions. See Section 1.1.2, “The Levels of the PowerPC Architecture,” for more information about the various levels defined by the PowerPC architecture.

4.1 Conventions

- U This section describes conventions used for the PowerPC instruction set. Descriptions of computation modes, memory addressing, synchronization, and the PowerPC exception summary follow.

4.1.1 Sequential Execution Model

The PowerPC processors appear to execute instructions in program order, regardless of asynchronous events or program exceptions. The execution of a sequence of instructions may be interrupted by an exception caused by one of the instructions in the sequence, or by an asynchronous event. (Note that the architecture specification refers to exceptions as interrupts.)

For exceptions to the sequential execution model, refer to Chapter 6, “Exceptions.” For information about the synchronization required when using store instructions to access instruction areas of memory, refer to Section 4.2.3.3, “Integer Store Instructions,” and Section 5.1.5.2, “Instruction Cache Instructions.” For information regarding instruction fetching, and for information about guarded memory refer to Section 5.2.1.5, “The Guarded Attribute (G).”

4.1.2 Computation Modes

The PowerPC architecture allows for the following types of implementations:

- 64-bit implementations, in which all general-purpose and floating-point registers, and some special-purpose registers (SPRs) are 64 bits long, and effective addresses are 64 bits long. All 64-bit implementations have two modes of operation: 64-bit mode (which is the default) and 32-bit mode. The mode controls how the effective address is interpreted, how condition bits are set, and how the count register (CTR) is tested by branch conditional instructions. All instructions provided for 64-bit implementations are available in both 64- and 32-bit modes.

The machine state register bit 0, MSR[SF], is used to choose between 64- and 32-bit modes. When MSR[SF] = 0, the processor runs in 32-bit mode, and when MSR[SF] = 1 the processor runs in the default 64-bit mode.

- 32-bit implementations, in which all registers except the FPRs are 32 bits long, and effective addresses are 32 bits long.

Instructions defined in this chapter are provided in both 64-bit implementations and 32-bit implementations unless otherwise stated. Instructions defined only for 64-bit implementations are illegal in 32-bit implementations, and vice versa.

4.1.2.1 64-Bit Implementations

In both 64-bit mode (the default) and 32-bit mode of a 64-bit implementation, instructions that set a 64-bit register affect all 64 bits, and the value placed into the register is independent of mode. In both modes, effective address computations use all 64 bits of the relevant registers (GPRs, LR, CTR, etc.), and produce a 64-bit result; however, in 32-bit mode (MSR[SF] = 0), only the low-order 32 bits of the computed effective address are used to address memory.

4.1.2.2 32-Bit Implementations

For a 32-bit implementation, all references to 64-bit implementations should be disregarded. The semantics of instructions for 32-bit implementations are the same as the 32-bit mode definitions for 64-bit implementations, except that in a 32-bit implementation all registers except FPRs are 32 bits long.

4.1.3 Classes of Instructions

PowerPC instructions belong to one of the following three classes:

- Defined
- Illegal
- Reserved

Note that while the definitions of these terms are consistent among the PowerPC processors, the assignment of these classifications is not. For example, an instruction that is specific to 64-bit implementations is considered defined for 64-bit implementations but illegal for 32-bit implementations.

The class is determined by examining the primary opcode, and the extended opcode if any. If the opcode, or the combination of opcode and extended opcode, is not that of a defined instruction or of a reserved instruction, the instruction is illegal.

In future versions of the PowerPC architecture, instruction codings that are now illegal may become defined (by being added to the architecture) or reserved (by being assigned to one of the special purposes). Likewise, reserved instructions may become defined.

4.1.3.1 Definition of Boundedly Undefined

The results of executing a given instruction are said to be boundedly undefined if they could have been achieved by executing an arbitrary sequence of instructions, starting in the state the machine was in before executing the given instruction. Boundedly undefined results for a given instruction may vary between implementations, and between different executions on the same implementation.

4.1.3.2 Defined Instruction Class

Defined instructions contain all the instructions defined in the PowerPC UISA, VEA, and OEA. Defined instructions are guaranteed to be supported in all PowerPC implementations. The only exceptions are instructions that are defined only for 64-bit implementations, instructions that are defined only for 32-bit implementations, and optional instructions, as stated in the instruction descriptions in Chapter 8, “Instruction Set.” A PowerPC processor may invoke the illegal instruction error handler (part of the program exception handler) when an unimplemented PowerPC instruction is encountered so that it may be emulated in software, as required.

A defined instruction can have invalid forms, as described in Section 4.1.3.2.2, “Invalid Instruction Forms.”

4.1.3.2.1 Preferred Instruction Forms

A defined instruction may have an instruction form that is preferred (that is, the instruction will execute in an efficient manner). Any form other than the preferred form will take significantly longer to execute. The following instructions have preferred forms:

- Load/store multiple instructions
- Load/store string instructions
- Or immediate instruction (preferred form of no-op)

4.1.3.2.2 Invalid Instruction Forms

A defined instruction may have an instruction form that is invalid if one or more operands, excluding opcodes, are coded incorrectly in a manner that can be deduced by examining only the instruction encoding (primary and extended opcodes). Attempting to execute an invalid form of an instruction either invokes the illegal instruction error handler (a program exception) or yields boundedly-undefined results. See Chapter 8, “Instruction Set,” for individual instruction descriptions.

Invalid forms result when a bit or operand is coded incorrectly, for example, or when a reserved bit (shown as ‘0’) is coded as ‘1’.

The following instructions have invalid forms identified in their individual instruction descriptions:

- Branch conditional instructions
- Load/store with update instructions
- Load multiple instructions
- Load string instructions
- Integer compare instructions (in 32-bit implementations only)
- Load/store floating-point with update instructions

4.1.3.2.3 Optional Instructions

A defined instruction may be optional. The optional instructions fall into the following categories:

- General-purpose instructions—**fsqrt** and **fsqrts**
- Graphics instructions—**fres**, **frsrte**, and **fsel**
- External control instructions—**eciwx** and **ecowx** V
- Lookaside buffer management instructions—**slbia**, **slbie**, **tlbia**, **tlbie**, and **tlbsync** O
(with conditions, see Chapter 8, “Instruction Set,” for more information)

TEMPORARY 64-BIT BRIDGE

The optional 64-bit bridge facility has three other categories of optional instructions for 64-bit implementations. These are described in greater detail in Section 7.9, “Migration of Operating Systems from 32-Bit Implementations to 64-Bit Implementations,” and summarized below:

- 32-bit segment register support instructions—**mtsr**, **mtsrin**, **mfsr**, and **mfsrin**
- 32-bit system linkage instructions—**rfi** and **mtmsr**
- 64-bit segment register support instructions—**mtsrđ** and **mtsrđin**

- U Note that the **stfiwx** instruction is defined as optional by the PowerPC architecture to ensure backwards compatibility with earlier processors; however, it will likely be required for subsequent PowerPC processors.

Also, note that additional categories may be defined in future implementations. If an implementation claims to support a given category, it implements all the instructions in that category.

Any attempt to execute an optional instruction that is not provided by the implementation will cause the illegal instruction error handler to be invoked. Exceptions to this rule are stated in the instruction descriptions found in Chapter 8, “Instruction Set.”

4.1.3.3 Illegal Instruction Class

Illegal instructions can be grouped into the following categories:

- Instructions that are not implemented in the PowerPC architecture. These opcodes are available for future extensions of the PowerPC architecture; that is, future versions of the PowerPC architecture may define any of these instructions to perform new functions. The following primary opcodes are defined as illegal but may be used in future extensions to the architecture:

1, 4, 5, 6, 56, 57, 60, 61

- Instructions that are implemented in the PowerPC architecture but are not implemented in a specific PowerPC implementation. For example, instructions specific to 64-bit PowerPC processors are illegal for 32-bit processors.

The following primary opcodes are defined for 64-bit implementations only and are illegal on 32-bit implementations:

2, 30, 58, 62

- All unused extended opcodes are illegal. The unused extended opcodes can be determined from information in Section A.2, “Instructions Sorted by Opcode,” and Section 4.1.3.4, “Reserved Instructions.” Notice that extended opcodes for instructions that are defined only for 64-bit implementations are illegal in 32-bit implementations. The following primary opcodes have unused extended opcodes.

19, 31, 59, 63 (primary opcodes 30 and 62 are illegal for 32-bit implementations, but as 64-bit opcodes they have some unused extended opcodes)

- An instruction consisting entirely of zeros is guaranteed to be an illegal instruction. This increases the probability that an attempt to execute data or uninitialized memory invokes the illegal instruction error handler (a program exception). Note that if only the primary opcode consists of all zeros, the instruction is considered a reserved instruction, as described in Section 4.1.3.4, “Reserved Instructions.”

An attempt to execute an illegal instruction invokes the illegal instruction error handler (a program exception) but has no other effect. See Section 6.4.7, “Program Exception (0x00700),” for additional information about illegal instruction exception.

With the exception of the instruction consisting entirely of binary zeros, the illegal instructions are available for further additions to the PowerPC architecture.

4.1.3.4 Reserved Instructions

Reserved instructions are allocated to specific implementation-dependent purposes not defined by the PowerPC architecture. An attempt to execute an unimplemented reserved instruction invokes the illegal instruction error handler (a program exception). See Section 6.4.7, “Program Exception (0x00700),” for additional information about illegal instruction exception.

The following types of instructions are included in this class:

1. Instructions for the POWER architecture that have not been included in the PowerPC architecture.
2. Implementation-specific instructions used to conform to the PowerPC architecture specifications (for example, Load Data TLB Entry (**tlbld**) and Load Instruction TLB Entry (**tlbli**) instructions for the PowerPC 603™ microprocessor).
3. The instruction with primary opcode 0, when the instruction does not consist entirely of binary zeros
4. Any other implementation-specific instructions that are not defined in the UISA, VEA, or OEA

4.1.4 Memory Addressing

A program references memory using the effective (logical) address computed by the processor when it executes a load, store, branch, or cache instruction, and when it fetches the next sequential instruction.

U
V
O

4.1.4.1 Memory Operands

Bytes in memory are numbered consecutively starting with zero. Each number is the address of the corresponding byte.

U

Memory operands may be bytes, half words, words, or double words, or, for the load/store multiple and load/store string instructions, a sequence of bytes or words. The address of a memory operand is the address of its first byte (that is, of its lowest-numbered byte). Operand length is implicit for each instruction. The PowerPC architecture supports both big-endian and little-endian byte ordering. The default byte and bit ordering is big-endian; see Section 3.1.2, “Byte Ordering,” for more information.

The operand of a single-register memory access instruction has a natural alignment boundary equal to the operand length. In other words, the “natural” address of an operand is an integral multiple of the operand length. A memory operand is said to be aligned if it is aligned at its natural boundary; otherwise it is misaligned. For a detailed discussion about memory operands, see Chapter 3, “Operand Conventions.”

4.1.4.2 Effective Address Calculation

An effective address (EA) is the 64- or 32-bit sum computed by the processor when executing a memory access or branch instruction or when fetching the next sequential instruction. For a memory access instruction, if the sum of the effective address and the operand length exceeds the maximum effective address, the memory operand is considered to wrap around from the maximum effective address through effective address 0, as described in the following paragraphs.

Effective address computations for both data and instruction accesses use 64- or 32-bit unsigned binary arithmetic. A carry from bit 0 is ignored. In a 64-bit implementation, the 64-bit current instruction address and next instruction address are not affected by a change from 32-bit mode to the default 64-bit mode, but a change from the default 64-bit mode to 32-bit mode causes the high-order 32 bits to be cleared.

In the default 64-bit mode, the entire 64-bit result comprises the 64-bit effective address. The effective address arithmetic wraps around from the maximum address, $2^{64} - 1$, to address 0.

- U When a 64-bit implementation executes in 32-bit mode ($MSR[SF] = 0$), the low-order 32 bits of the 64-bit result comprise the effective address for the purpose of addressing memory. The high-order 32 bits of the 64-bit effective address are ignored for the purpose of accessing data, but are included whenever a 64-bit effective address is placed into a GPR by load with update and store with update instructions. The high-order 32 bits of the 64-bit effective address are cleared for the purpose of fetching instructions, and whenever a 64-bit effective address is placed into the LR by branch instructions having link register update option enabled (LK field, bit 31, in the instruction encoding = 1). The high-order 32 bits of the 64-bit effective address are cleared in SPRs when an exception error handler is invoked. In the context of addressing memory, the effective address arithmetic appears to wrap around from the maximum address, $2^{32} - 1$, to address zero.
- U Treating the high-order 32 bits of the effective address as zero effectively truncates the 64-bit effective address to a 32-bit effective address such as would have been generated on a 32-bit implementation.

In 32-bit implementations, the 32-bit result comprises the 32-bit effective address.

In all implementations (including 32-bit mode in 64-bit implementations), the three low-order bits of the calculated effective address may be modified by the processor before accessing memory if the PowerPC system is operating in little-endian mode. See Section 3.1.2, “Byte Ordering,” for more information about little-endian mode.

Load and store operations have three categories of effective address generation that depend on the operands specified:

- Register indirect with immediate index mode
- Register indirect with index mode
- Register indirect mode

See Section 4.2.3.1, “Integer Load and Store Address Generation,” for a detailed description of effective address generation for load and store operations.

Branch instructions have three categories of effective address generation:

- Immediate addressing.
- Link register indirect
- Count register indirect

See Section 4.2.4.1, “Branch Instruction Address Calculation,” for a detailed description of effective address generation for branch instructions.

Branch instructions can optionally load the LR with the next sequential instruction address (current instruction address + 4).

4.1.5 Synchronizing Instructions

The synchronization described in this section refers to the state of activities within the processor that is performing the synchronization. Refer to Section 6.1.2, “Synchronization,” for more detailed information about other conditions that can cause context and execution synchronization.

4.1.5.1 Context Synchronizing Instructions

The System Call (**sc**), Return from Interrupt (**rfi**), Return from Interrupt Double Word (**rfd**), and Instruction Synchronize (**isync**) instructions perform context synchronization by allowing previously issued instructions to complete before performing a context switch. Execution of one of these instructions ensures the following:

1. No higher priority exception exists (**sc**) and instruction dispatching is halted.
2. All previous instructions have completed to a point where they can no longer cause an exception.

If a prior memory access instruction causes one or more direct-store interface error exceptions, the results are guaranteed to be determined before this instruction is executed. However, note that the direct-store facility is being phased out of the architecture and will not likely be supported in future devices.

3. Previous instructions complete execution in the context (privilege, protection, and address translation) under which they were issued.
4. The instructions following the **sc**, **rfi**, **rfd**, or **isync** instruction execute in the context established by these instructions.

4.1.5.2 Execution Synchronizing Instructions

An instruction is execution synchronizing if it satisfies the conditions of the first two items described above for context synchronization. The **sync** instruction is treated like **isync** with respect to the second item described above (that is, the conditions described in the second item apply to the completion of **sync**). The **sync** and **mtmsr** instructions are examples of execution-synchronizing instructions.

All context-synchronizing instructions are execution-synchronizing. Unlike a context synchronizing operation, an execution synchronizing instruction need not ensure that the instructions following it execute in the context established by that instruction. This new context becomes effective sometime after the execution synchronizing instruction completes and before or at a subsequent context synchronizing operation.

4.1.6 Exception Summary

- U PowerPC processors have an exception mechanism for handling system functions and error conditions in an orderly way. The exception model is defined by the OEA. There are two kinds of exceptions—those caused directly by the execution of an instruction and those caused by an asynchronous event. Either may cause components of the system software to be invoked.

Exceptions can be caused directly by the execution of an instruction as follows:

- An attempt to execute an illegal instruction causes the illegal instruction (program exception) error handler to be invoked. An attempt by a user-level program to execute the supervisor-level instructions listed below causes the privileged instruction (program exception) handler to be invoked.

- U The PowerPC architecture provides the following supervisor-level instructions:
 V **dcbi**, **mfmsr**, **mf spr**, **mfsr**, **mfsrin**, **mtmsr**, **mtmsrd**, **mtspr**, **mtsr**, **mtsr d**, **mtsrin**,
 O **mtsr d in**, **r fi**, **rfd**, **slbia**, **slbie**, **tlbia**, **tlbie**, and **tlbsync** (defined by OEA). Note that the privilege level of the **mf spr** and **mtspr** instructions depends on the SPR encoding.

- U • The execution of a defined instruction using an invalid form causes either the illegal instruction error handler or the privileged instruction handler to be invoked.
- The execution of an optional instruction that is not provided by the implementation causes the illegal instruction error handler to be invoked.
- An attempt to access memory in a manner that violates memory protection, or an attempt to access memory that is not available (page fault), causes the DSI exception handler or ISI exception handler to be invoked.

- An attempt to access memory with an effective address alignment that is invalid for the instruction causes the alignment exception handler to be invoked.
- The execution of an `sc` instruction permits a program to call on the system to perform a service, by causing a system call exception handler to be invoked.
- The execution of a trap instruction invokes the program exception trap handler.
- The execution of a floating-point instruction when floating-point instructions are disabled invokes the floating-point unavailable exception handler.
- The execution of an instruction that causes a floating-point exception that is enabled invokes the floating-point enabled exception handler.
- The execution of a floating-point instruction that requires system software assistance causes the floating-point assist exception handler to be invoked. The conditions under which such software assistance is required are implementation-dependent.

Exceptions caused by asynchronous events are described in Chapter 6, “Exceptions.”

4.2 PowerPC UISA Instructions

The PowerPC user instruction set architecture (UISA) includes the base user-level instruction set (excluding a few user-level cache-control, synchronization, and time base instructions), user-level registers, programming model, data types, and addressing modes. This section discusses the instructions defined in the UISA.

4.2.1 Integer Instructions

The integer instructions consist of the following:

- Integer arithmetic instructions
- Integer compare instructions
- Integer logical instructions
- Integer rotate and shift instructions

Integer instructions use the content of the GPRs as source operands and place results into GPRs. Integer arithmetic, shift, rotate, and string move instructions may update or read values from the XER, and the condition register (CR) fields may be updated if the `Rc` bit of the instruction is set.

These instructions treat the source operands as signed integers unless the instruction is explicitly identified as performing an unsigned operation. For example, Multiply High-Word Unsigned (**mulhwu**) and Divide Word Unsigned (**divwu**) instructions interpret both operands as unsigned integers.

The integer instructions that are coded to update the condition register, and the integer arithmetic instruction, **addic**, set CR bits 0–3 (CR0) to characterize the result of the operation. In the default 64-bit mode, CR0 is set to reflect a signed comparison of the 64-bit result to zero. In 32-bit mode (of 64-bit implementations), CR0 is set to reflect a signed comparison of the low-order 32 bits of the result to zero.

The integer arithmetic instructions, **addic**, **addic.**, **subfic**, **addc**, **subfc**, **adde**, **subfe**, **addme**, **subfme**, **addze**, and **subfze**, always set the XER bit, CA, to reflect the carry out of bit 0 in the default 64-bit mode and out of bit 32 in 32-bit mode (of 64-bit implementations). Integer arithmetic instructions with the overflow enable (OE) bit set in the instruction encoding (instructions with o suffix) cause the XER[SO] and XER[OV] to reflect an overflow of the result. Except for the multiply low and divide instructions, these integer arithmetic instructions reflect the overflow of the 64-bit result in the default 64-bit mode and overflow of the low-order 32-bit result in 32-bit mode; however, the multiply low and divide instructions (**mulld**, **mullw**, **divd**, **divw**, **divdu**, and **divwu**) with o suffix cause XER[SO] and XER[OV] to reflect overflow of the 64-bit result (**mulld**, **divd**, and **divdu**) and overflow of the low-order 32-bit result (**mullw**, **divw**, and **divwu**).

Instructions that select the overflow option (enable XER[OV]) or that set the XER carry bit (CA) may delay the execution of subsequent instructions.

Unless otherwise noted, when CR0 and the XER are set, they reflect the value placed in the target register.

4.2.1.1 Integer Arithmetic Instructions

Table 4-1 lists the integer arithmetic instructions for the PowerPC processors.

Table 4-1. Integer Arithmetic Instructions

Name	Mnemonic	Operand Syntax	Operation
Add Immediate	addi	rD,rA,SIMM	The sum (rA 0) + SIMM is placed into rD.
Add Immediate Shifted	addis	rD,rA,SIMM	The sum (rA 0) + (SIMM 0x0000) is placed into rD.

Table 4-1. Integer Arithmetic Instructions (Continued)

Name	Mnemonic	Operand Syntax	Operation
Add	add add. addo addo.	rD,rA,rB	The sum $(rA) + (rB)$ is placed into rD. add Add add. Add with CR Update. The dot suffix enables the update of the CR. addo Add with Overflow Enabled. The o suffix enables the overflow bit (OV) in the XER. addo. Add with Overflow and CR Update. The o. suffix enables the update of the CR and enables the overflow bit (OV) in the XER.
Subtract From	subf subf. subfo subfo.	rD,rA,rB	The sum $\neg (rA) + (rB) + 1$ is placed into rD. subf Subtract From subf. Subtract from with CR Update. The dot suffix enables the update of the CR. subfo Subtract from with Overflow Enabled. The o suffix enables the overflow bit (OV) in the XER. subfo. Subtract from with Overflow and CR Update. The o. suffix enables the update of the CR and enables the overflow bit (OV) in the XER.
Add Immediate Carrying	addic	rD,rA,SIMM	The sum $(rA) + \text{SIMM}$ is placed into rD.
Add Immediate Carrying and Record	addic.	rD,rA,SIMM	The sum $(rA) + \text{SIMM}$ is placed into rD. The CR is updated.
Subtract from Immediate Carrying	subfic	rD,rA,SIMM	The sum $\neg (rA) + \text{SIMM} + 1$ is placed into rD.
Add Carrying	addc addc. addco addco.	rD,rA,rB	The sum $(rA) + (rB)$ is placed into rD. addc Add Carrying addc. Add Carrying with CR Update. The dot suffix enables the update of the CR. addco Add Carrying with Overflow Enabled. The o suffix enables the overflow bit (OV) in the XER. addco. Add Carrying with Overflow and CR Update. The o. suffix enables the update of the CR and enables the overflow bit (OV) in the XER.
Subtract from Carrying	subfc subfc. subfco subfco.	rD,rA,rB	The sum $\neg (rA) + (rB) + 1$ is placed into rD. subfc Subtract from Carrying subfc. Subtract from Carrying with CR Update. The dot suffix enables the update of the CR. subfco Subtract from Carrying with Overflow. The o suffix enables the overflow bit (OV) in the XER. subfco. Subtract from Carrying with Overflow and CR Update. The o. suffix enables the update of the CR and enables the overflow bit (OV) in the XER.

Table 4-1. Integer Arithmetic Instructions (Continued)

Name	Mnemonic	Operand Syntax	Operation
Add Extended	adde adde. addeo addeo.	rD,rA,rB	The sum $(rA) + (rB) + XER[CA]$ is placed into rD. adde Add Extended adde. Add Extended with CR Update. The dot suffix enables the update of the CR. addeo Add Extended with Overflow. The o suffix enables the overflow bit (OV) in the XER. addeo. Add Extended with Overflow and CR Update. The o. suffix enables the update of the CR and enables the overflow bit (OV) in the XER.
Subtract from Extended	subfe subfe. subfeo subfeo.	rD,rA,rB	The sum $\neg(rA) + (rB) + XER[CA]$ is placed into rD. subfe Subtract from Extended subfe. Subtract from Extended with CR Update. The dot suffix enables the update of the CR. subfeo Subtract from Extended with Overflow. The o suffix enables the overflow bit (OV) in the XER. subfeo. Subtract from Extended with Overflow and CR Update. The o. suffix enables the update of the CR and enables the overflow (OV) bit in the XER.
Add to Minus One Extended	addme addme. addmeo addmeo.	rD,rA	The sum $(rA) + XER[CA]$ added to 0xFFFF_FFFF_FFFF_FFFF for 64-bit implementations (0xFFFF_FFFF for 32-bit implementations) is placed into rD. addme Add to Minus One Extended addme. Add to Minus One Extended with CR Update. The dot suffix enables the update of the CR. addmeo Add to Minus One Extended with Overflow. The o suffix enables the overflow bit (OV) in the XER. addmeo. Add to Minus One Extended with Overflow and CR Update. The o. suffix enables the update of the CR and enables the overflow (OV) bit in the XER.
Subtract from Minus One Extended	subfme subfme. subfmeo subfmeo.	rD,rA	The sum $\neg(rA) + XER[CA]$ added to 0xFFFF_FFFF_FFFF_FFFF for 64-bit implementations (0xFFFF_FFFF for 32-bit implementations) is placed into rD. subfme Subtract from Minus One Extended subfme. Subtract from Minus One Extended with CR Update. The dot suffix enables the update of the CR. subfmeo Subtract from Minus One Extended with Overflow. The o suffix enables the overflow bit (OV) in the XER. subfmeo. Subtract from Minus One Extended with Overflow and CR Update. The o. suffix enables the update of the CR and enables the overflow bit (OV) in the XER.
Add to Zero Extended	addze addze. addzeo addzeo.	rD,rA	The sum $(rA) + XER[CA]$ is placed into rD. addze Add to Zero Extended addze. Add to Zero Extended with CR Update. The dot suffix enables the update of the CR. addzeo Add to Zero Extended with Overflow. The o suffix enables the overflow bit (OV) in the XER. addzeo. Add to Zero Extended with Overflow and CR Update. The o. suffix enables the update of the CR and enables the overflow bit (OV) in the XER.

Table 4-1. Integer Arithmetic Instructions (Continued)

Name	Mnemonic	Operand Syntax	Operation
Subtract from Zero Extended	subfze subfze. subfzео subfzeо.	rD,rA	The sum $\neg (rA) + XER[CA]$ is placed into rD. subfze Subtract from Zero Extended subfze. Subtract from Zero Extended with CR Update. The dot suffix enables the update of the CR. subfzео Subtract from Zero Extended with Overflow. The o suffix enables the overflow bit (OV) in the XER. subfzeо. Subtract from Zero Extended with Overflow and CR Update. The o. suffix enables the update of the CR and enables the overflow bit (OV) in the XER.
Negate	neg neg. nego nego.	rD,rA	The sum $\neg (rA) + 1$ is placed into rD. neg Negate neg. Negate with CR Update. The dot suffix enables the update of the CR. nego Negate with Overflow. The o suffix enables the overflow bit (OV) in the XER. nego. Negate with Overflow and CR Update. The o. suffix enables the update of the CR and enables the overflow bit (OV) in the XER.
Multiply Low Immediate	mulli	rD,rA,SIMM	The low-order 64 bits of the 128-bit product $(rA) * SIMM$ are placed into rD. This instruction can be used with mulhdx or mulhwx to calculate a full 128-bit (or 64-bit) product. The low-order 32 bits of the product are the correct 32-bit product for 32-bit implementations and for 32-bit mode in 64-bit implementations.
Multiply Low	mullw mullw. mullwo mullwo.	rD,rA,rB	The 64-bit product $(rA) * (rB)$ is placed into register rD. The 32-bit operands are the contents of the low-order 32 bits of rA and of rB. This instruction can be used with mulhwx to calculate a full 64-bit product. The low-order 32 bits of the product are the correct 32-bit product for 32-bit implementations and for 32-bit mode in 64-bit implementations. mullw Multiply Low mullw. Multiply Low with CR Update. The dot suffix enables the update of the CR. mullwo Multiply Low with Overflow. The o suffix enables the overflow bit (OV) in the XER. mullwo. Multiply Low with Overflow and CR Update. The o. suffix enables the update of the condition register and enables the overflow bit (OV) in the XER.
Multiply Low Double Word (64-bit only)	mulld mulld. mulldо mulldо.	rD,rA,rB	The low-order 64 bits of the 128-bit product $(rA) * (rB)$ are placed into rD. mulld Multiply Low Double Word mulld. Multiply Low Double Word with CR Update. The dot suffix enables the update of the CR. mulldо Multiply Low Double Word with Overflow. The o suffix enables the overflow bit (OV) in the XER. mulldо. Multiply Low Double Word with Overflow and CR Update. The o. suffix enables the update of the CR and enables the overflow bit (OV) in the XER.

Table 4-1. Integer Arithmetic Instructions (Continued)

Name	Mnemonic	Operand Syntax	Operation
Multiply High Word	mulhw mulhw.	rD,rA,rB	The contents of rA and rB are interpreted as 32-bit signed integers. The 64-bit product is formed. The high-order 32 bits of the 64-bit product are placed into the low-order 32 bits of rD. The value in the high-order 32 bits of rD is undefined. mulhw Multiply High Word mulhw. Multiply High Word with CR Update. The dot suffix enables the update of the CR.
Multiply High Double Word (64-bit only)	mulhd mulhd.	rD,rA,rB	The high-order 64 bits of the 128-bit product (rA) * (rB) are placed into register rD. Both operands and the product are interpreted as signed integers. muld Multiply High Double Word muld. Multiply High Double Word with CR Update. The dot suffix enables the update of the CR.
Multiply High Word Unsigned	mulhwu mulhwu.	rD,rA,rB	The contents of rA and of rB are interpreted as 32-bit unsigned integers. The 64-bit product is formed. The high-order 32 bits of the 64-bit product are placed into the low-order 32 bits of rD. The value in the high-order 32 bits of rD is undefined. mulhwu Multiply High Word Unsigned mulhwu. Multiply High Word Unsigned with CR Update. The dot suffix enables the update of the CR.
Multiply High Double Word Unsigned (64-bit only)	mulhdu mulhdu.	rD,rA,rB	The high-order 64 bits of the 128-bit product (rA) * (rB) are placed into register rD. mulhdu Multiply High Word Unsigned mulhdu. Multiply High Word Unsigned with CR Update. The dot suffix enables the update of the CR.
Divide Word	divw divw. divwo divwo.	rD,rA,rB	The 64-bit dividend is the signed value of the low-order 32 bits of rA. The 64-bit divisor is the signed value of the low-order 32 bits of rB. The low-order 32 bits of the 64-bit quotient are placed into the low-order 32 bits of rD. The contents of the high-order 32 bits of rD are undefined for 64-bit implementations. The remainder is not supplied as a result. divw Divide Word divw. Divide Word with CR Update. The dot suffix enables the update of the CR. divwo Divide Word with Overflow. The o suffix enables the overflow bit (OV) in the XER. divwo. Divide Word with Overflow and CR Update. The o. suffix enables the update of the CR and enables the overflow bit (OV) in the XER.
Divide Double Word (64-bit only)	divd divd. divdo divdo.	rD,rA,rB	The 64-bit dividend is (rA). The 64-bit divisor is (rB). The 64-bit quotient is placed into rD. The remainder is not supplied as a result. divd Divide Double Word divd. Divide Double Word with CR Update. The dot suffix enables the update of the CR. divdo Divide Double Word with Overflow. The o suffix enables the overflow bit (OV) in the XER. divdo. Divide Double Word with Overflow and CR Update. The o. suffix enables the update of the CR and enables the overflow bit (OV) in the XER.

Table 4-1. Integer Arithmetic Instructions (Continued)

Name	Mnemonic	Operand Syntax	Operation
Divide Word Unsigned	divwu divwu. divwuo divwuo.	rD,rA,rB	<p>The 64-bit dividend is the zero-extended value in the low-order 32 bits of rA. The 64-bit divisor is the zero-extended value in the low-order 32 bits of rB. The low-order 32 bits of the 64-bit quotient are placed into the low-order 32 bits of rD. The contents of the high-order 32 bits of rD are undefined for 64-bit implementations. The remainder is not supplied as a result.</p> <p>divwu Divide Word Unsigned divwu. Divide Word Unsigned with CR Update. The dot suffix enables the update of the CR. divwuo Divide Word Unsigned with Overflow. The o suffix enables the overflow bit (OV) in the XER. divwuo. Divide Word Unsigned with Overflow and CR Update. The o. suffix enables the update of the CR and enables the overflow bit (OV) in the XER.</p>
Divide Double Word Unsigned (64-bit only)	divdu divdu. divduo divduo.	rD,rA,rB	<p>The 64-bit dividend is (rA). The 64-bit divisor is (rB). The 64-bit quotient is placed into rD. The remainder is not supplied as a result.</p> <p>divdu Divide Word Unsigned divdu. Divide Word Unsigned with CR Update. The dot suffix enables the update of the CR. divduo Divide Word Unsigned with Overflow. The o suffix enables the overflow bit (OV) in the XER. divduo. Divide Word Unsigned with Overflow and CR Update. The o. suffix enables the update of the CR and enables the overflow bit (OV) in the XER.</p>

Although there is no “Subtract Immediate” instruction, its effect can be achieved by using an **addi** instruction with the immediate operand negated. Simplified mnemonics are provided that include this negation. The **subf** instructions subtract the second operand (rA) from the third operand (rB). Simplified mnemonics are provided in which the third operand is subtracted from the second operand. See Appendix F, “Simplified Mnemonics,” for examples.

4.2.1.2 Integer Compare Instructions

The integer compare instructions algebraically or logically compare the contents of register rA with either the zero-extended value of the UIMM operand, the sign-extended value of the SIMM operand, or the contents of register rB. The comparison is signed for the **cmpi** and **cmp** instructions, and unsigned for the **cmpli** and **cmpl** instructions. Table 4-2 summarizes the integer compare instructions.

For 64-bit implementations, the PowerPC UISA specifies that the value in the L field determines whether the operands are treated as 32- or 64-bit values. If the L field is 0 the operand length is 32 bits, and if it is 1 the operand length is 64 bits. The simplified mnemonics for integer compare instructions, as shown in Appendix F, “Simplified Mnemonics,” correctly set or clear the L value in the instruction encoding rather than requiring it to be coded as a numeric operand.

When operands are treated as 32-bit signed quantities, bit 32 of (**rA**) and (**rB**) is the sign bit. For 32-bit implementations, the L field must be cleared, otherwise the instruction form is invalid.

The integer compare instructions (shown in Table 4-2) set one of the leftmost three bits of the designated CR field, and clear the other two. XER[SO] is copied into bit 3 of the CR field.

Table 4-2. Integer Compare Instructions

Name	Mnemonic	Operand Syntax	Operation
Compare Immediate	cmpi	crfD ,L,rA,SIMM	The value in register rA (rA [32–63] sign-extended to 64 bits if L = 0) is compared with the sign-extended value of the SIMM operand, treating the operands as signed integers. The result of the comparison is placed into the CR field specified by operand crfD .
Compare	cmp	crfD ,L,rA,rB	The value in register rA (rA [32–63] if L = 0) is compared with the value in register rB (rB [32–63] if L = 0), treating the operands as signed integers. The result of the comparison is placed into the CR field specified by operand crfD .
Compare Logical Immediate	cmpli	crfD ,L,rA,UIMM	The value in register rA (rA [32–63] zero-extended to 64 bits if L = 0) is compared with 0x0000_0000_0000 UIMM, treating the operands as unsigned integers. The result of the comparison is placed into the CR field specified by operand crfD .
Compare Logical	cmpl	crfD ,L,rA,rB	The value in register rA (rA [32–63] if L = 0) is compared with the value in register rB (rB [32–63] if L = 0), treating the operands as unsigned integers. The result of the comparison is placed into the CR field specified by operand crfD .

The **crfD** operand can be omitted if the result of the comparison is to be placed in CR0. Otherwise the target CR field must be specified in the instruction **crfD** field, using an explicit field number.

For information on simplified mnemonics for the integer compare instructions see Appendix F, “Simplified Mnemonics.”

4.2.1.3 Integer Logical Instructions

The logical instructions shown in Table 4-3 perform bit-parallel operations on 64-bit operands. Logical instructions with the CR updating enabled (uses dot suffix) and instructions **andi.** and **andis.** set CR field CR0 (bits 0 to 2) to characterize the result of the logical operation. In the default 64-bit mode, these fields are set as if the 64-bit result were compared algebraically to zero. In 32-bit mode of a 64-bit implementation, these fields are set as if the sign-extended low-order 32 bits of the result were algebraically compared to zero. Logical instructions without CR update and the remaining logical instructions do not modify the CR. Logical instructions do not affect the XER[SO], XER[OV], and XER[CA] bits.

See Appendix F, “Simplified Mnemonics,” for simplified mnemonic examples for integer logical operations.

Table 4-3. Integer Logical Instructions

Name	Mnemonic	Operand Syntax	Operation
AND Immediate	andi.	rA,rS,UIMM	The contents of rS are ANDed with 0x0000_0000_0000 UIMM and the result is placed into rA. The CR is updated.
AND Immediate Shifted	andis.	rA,rS,UIMM	The content of rS are ANDed with 0x0000_0000 UIMM 0x0000 and the result is placed into rA. The CR is updated.
OR Immediate	ori	rA,rS,UIMM	The contents of rS are ORed with 0x0000_0000_0000 UIMM and the result is placed into rA. The preferred no-op is ori 0,0,0
OR Immediate Shifted	oris	rA,rS,UIMM	The contents of rS are ORed with 0x0000_0000 UIMM 0x0000 and the result is placed into rA.
XOR Immediate	xori	rA,rS,UIMM	The contents of rS are XORed with 0x0000_0000_0000 UIMM and the result is placed into rA.
XOR Immediate Shifted	xoris	rA,rS,UIMM	The contents of rS are XORed with 0x0000_0000 UIMM 0x0000 and the result is placed into rA.
AND	and and.	rA,rS,rB	The contents of rS are ANDed with the contents of register rB and the result is placed into rA. and AND and. AND with CR Update. The dot suffix enables the update of the CR.
OR	or or.	rA,rS,rB	The contents of rS are ORed with the contents of rB and the result is placed into rA. or OR or. OR with CR Update. The dot suffix enables the update of the CR.
XOR	xor xor.	rA,rS,rB	The contents of rS are XORed with the contents of rB and the result is placed into rA. xor XOR xor. XOR with CR Update. The dot suffix enables the update of the CR.
NAND	nand nand.	rA,rS,rB	The contents of rS are ANDed with the contents of rB and the one's complement of the result is placed into rA. nand NAND nand. NAND with CR Update. The dot suffix enables the update of CR. Note that nandx , with rS = rB, can be used to obtain the one's complement.
NOR	nor nor.	rA,rS,rB	The contents of rS are ORed with the contents of rB and the one's complement of the result is placed into rA. nor NOR nor. NOR with CR Update. The dot suffix enables the update of the CR. Note that norx , with rS = rB, can be used to obtain the one's complement.

Table 4-3. Integer Logical Instructions (Continued)

Name	Mnemonic	Operand Syntax	Operation
Equivalent	eqv eqv.	rA,rS,rB	The contents of rS are XORed with the contents of rB and the complemented result is placed into rA. eqv Equivalent eqv. Equivalent with CR Update. The dot suffix enables the update of the CR.
AND with Complement	andc andc.	rA,rS,rB	The contents of rS are ANDed with the one's complement of the contents of rB and the result is placed into rA. andc AND with Complement andc. AND with Complement with CR Update. The dot suffix enables the update of the CR.
OR with Complement	orc orc.	rA,rS,rB	The contents of rS are ORed with the complement of the contents of rB and the result is placed into rA. orc OR with Complement orc. OR with Complement with CR Update. The dot suffix enables the update of the CR.
Extend Sign Byte	extsb extsb.	rA,rS	The contents of the low-order eight bits of rS are placed into the low-order eight bits of rA. Bit 56 of rS (bit 24 in 32-bit implementations) is placed into the remaining high-order bits of rA. extsb Extend Sign Byte extsb. Extend Sign Byte with CR Update. The dot suffix enables the update of the CR.
Extend Sign Half Word	extsh extsh.	rA,rS	The contents of the low-order 16 bits of rS are placed into the low-order 16 bits of rA. Bit 48 of rS (bit 16 in 32-bit implementations) is placed into the remaining high-order bits of rA. extsh Extend Sign Half Word extsh. Extend Sign Half Word with CR Update. The dot suffix enables the update of the CR.
Extend Sign Word (64-bit only)	extsw extsw.	rA,rS	The contents of the low-order 32 bits of rS are placed into the low-order 32 bits of rA. Bit 32 of rS is placed into the remaining high-order bits of rA. extsw Extend Sign Word extsw. Extend Sign Word with CR Update. The dot suffix enables the update of the CR.
Count Leading Zeros Word	cntlzw cntlzw.	rA,rS	A count of the number of consecutive zero bits starting at bit 32 of rS (bit 0 in 32-bit implementations) is placed into rA. This number ranges from 0 to 32, inclusive. If Rc = 1 (dot suffix), LT is cleared in CR0. cntlzw Count Leading Zeros Word cntlzw. Count Leading Zeros Word with CR Update. The dot suffix enables the update of the CR.
Count Leading Zeros Double Word (64-bit only)	cntlzd cntlzd.	rA,rS	A count of the number of consecutive zero bits starting at bit 0 of rS is placed into rA. This number ranges from 0 to 64, inclusive. If Rc = 1 (dot suffix), LT is cleared in CR0. cntlzd Count Leading Zeros Double Word cntlzd. Count Leading Zeros Double Word with CR Update. The dot suffix enables the update of the CR.

4.2.1.4 Integer Rotate and Shift Instructions

Rotation operations are performed on data from a GPR, and the result, or a portion of the result, is returned to a GPR. The rotation operations rotate a 64-bit quantity left by a specified number of bit positions. Bits that exit from position 0 enter at position 63.

The rotate and shift instructions employ a mask generator. The mask is 64 bits long and consists of '1' bits from a start bit, *Mstart*, through and including a stop bit, *Mstop*, and '0' bits elsewhere. The values of *Mstart* and *Mstop* range from 0 to 63. If *Mstart* > *Mstop*, the '1' bits wrap around from position 63 to position 0. Thus the mask is formed as follows:

if $Mstart \leq Mstop$ then

 mask[mstart–mstop] = ones

 mask[all other bits] = zeros

else

 mask[mstart–63] = ones

 mask[0–mstop] = ones

 mask[all other bits] = zeros

It is not possible to specify an all-zero mask. The use of the mask is described in the following sections.

If CR updating is enabled, rotate and shift instructions set CR0[0–2] according to the contents of *rA* at the completion of the instruction. Rotate and shift instructions do not change the values of XER[OV] and XER[SO] bits. Rotate and shift instructions, except algebraic right shifts, do not change the XER[CA] bit.

See Appendix F, “Simplified Mnemonics,” for a complete list of simplified mnemonics that allows simpler coding of often-used functions such as clearing the leftmost or rightmost bits of a register, left justifying or right justifying an arbitrary field, and simple rotates and shifts.

4.2.1.4.1 Integer Rotate Instructions

Integer rotate instructions rotate the contents of a register. The result of the rotation is either inserted into the target register under control of a mask (if a mask bit is 1 the associated bit of the rotated data is placed into the target register, and if the mask bit is 0 the associated bit in the target register is unchanged), or ANDed with a mask before being placed into the target register.

Rotate left instructions allow right-rotation of the contents of a register to be performed by a left-rotation of $64 - n$, where n is the number of bits by which to rotate right. It also allows right-rotation of the contents of the low-order 32 bits of a register to be performed by a left-rotation of $32 - n$, where n is the number of bits by which to rotate right.

The integer rotate instructions are summarized in Table 4-4.

Table 4-4. Integer Rotate Instructions

Name	Mnemonic	Operand Syntax	Operation
Rotate Left Double Word Immediate then Clear Left (64-bit only)	rldicl rldicl.	rA,rS,SH,MB	The contents of rS are rotated left by the number of bits specified by operand SH. A mask is generated having 1 bits from the bit specified by operand MB through bit 63 and 0 bits elsewhere. The rotated data is ANDed with the generated mask and the result is placed into register rA. rldicl Rotate Left Double Word Immediate then Clear Left rldicl. Rotate Left Double Word Immediate then Clear Left with CR Update. The dot suffix enables the update of the CR.
Rotate Left Double Word Immediate then Clear Right (64-bit only)	rdicr rdicr.	rA,rS,SH,ME	The contents of rS are rotated left by the number of bits specified by operand SH. A mask is generated having 1 bits from bit 0 through the bit specified by operand ME and 0 bits elsewhere. The rotated data is ANDed with the generated mask and the result is placed into register rA. rdicr Rotate Left Double Word Immediate then Clear Right rdicr. Rotate Left Double Word Immediate then Clear Right with CR Update. The dot suffix enables the update of the CR.
Rotate Left Double Word Immediate then Clear (64-bit only)	rdic rdic.	rA,rS,SH,MB	The contents of register rS are rotated left by the number of bits specified by operand SH. A mask is generated having 1 bits from the bit specified by operand MB through bit 63 – SH, and 0 bits elsewhere. The rotated data is ANDed with the generated mask and the result is placed into register rA. rdic Rotate Left Double Word Immediate then Clear rdic. Rotate Left Double Word Immediate then Clear with CR Update. The dot suffix enables the update of the CR.
Rotate Left Word Immediate then AND with Mask	rlwinm rlwinm.	rA,rS,SH,MB,ME	The contents of register rS are rotated left by the number of bits specified by operand SH. A mask is generated having 1 bits from the bit specified by operand MB + 32 through the bit specified by operand ME + 32 and 0 bits elsewhere. The rotated data is ANDed with the generated mask and the result is placed into register rA. rlwinm Rotate Left Word Immediate then AND with Mask rlwinm. Rotate Left Word Immediate then AND with Mask with CR Update. The dot suffix enables the update of the CR.
Rotate Left Double Word then Clear Left (64-bit only)	rdcl rdcl.	rA,rS,rB,MB	The contents of register rS are rotated left by the number of bits specified by operand in the low-order six bits of rB. A mask is generated having 1 bits from the bit specified by operand MB through bit 63 and 0 bits elsewhere. The rotated data is ANDed with the generated mask and the result is placed into register rA. rdcl Rotate Left Double Word then Clear Left rdcl. Rotate Left Double Word then Clear Left with CR Update. The dot suffix enables the update of the CR.

Table 4-4. Integer Rotate Instructions (Continued)

Name	Mnemonic	Operand Syntax	Operation
Rotate Left Double Word then Clear Right (64-bit only)	rl dcr rl dcr.	rA,rS,rB,ME	The contents of register rS are rotated left by the number of bits specified by operand in the low-order six bits of rB. A mask is generated having 1 bits from bit 0 through the bit specified by operand ME and 0 bits elsewhere. The rotated data is ANDed with the generated mask and the result is placed into register rA. rl dcr Rotate Left Double Word then Clear Right rl dcr. Rotate Left Double Word then Clear Right with CR Update. The dot suffix enables the update of the CR.
Rotate Left Word then AND with Mask	rl wnm rl wnm.	rA,rS,rB,MB,ME	The contents of rS are rotated left by the number of bits specified by operand in the low-order five bits of rB. A mask is generated having 1 bits from the bit specified by operand MB + 32 through the bit specified by operand ME + 32 and 0 bits elsewhere. The rotated word is ANDed with the generated mask and the result is placed into rA. rl wnm Rotate Left Word then AND with Mask rl wnm. Rotate Left Word then AND with Mask with CR Update. The dot suffix enables the update of the CR.
Rotate Left Word Immediate then Mask Insert	rl wimi rl wimi.	rA,rS,SH,MB,ME	The contents of rS are rotated left by the number of bits specified by operand SH. A mask is generated having 1 bits from the bit specified by operand MB + 32 through the bit specified by operand ME + 32 and 0 bits elsewhere. The rotated word is inserted into rA under control of the generated mask. rl wimi Rotate Left Word Immediate then Mask rl wimi. Rotate Left Word Immediate then Mask Insert with CR Update. The dot suffix enables the update of the CR.
Rotate Left Double Word Immediate then Mask Insert (64-bit only)	rl dimi rl dimi.	rA,rS,SH,MB	The contents of rS are rotated left by the number of bits specified by operand SH. A mask is generated having 1 bits from the bit specified by operand MB through 63 – SH (the bit specified by SH), and 0 bits elsewhere. The rotated data is inserted into rA under control of the generated mask. rl dimi Rotate Left Word Immediate then Mask rl dimi. Rotate Left Word Immediate then Mask Insert with CR Update. The dot suffix enables the update of the CR.

4.2.1.4.2 Integer Shift Instructions

The integer shift instructions perform left and right shifts. Immediate-form logical (unsigned) shift operations are obtained by specifying masks and shift values for certain rotate instructions. Simplified mnemonics (shown in Appendix F, “Simplified Mnemonics”) are provided to make coding of such shifts simpler and easier to understand.

Any shift right algebraic instruction, followed by **addze**, can be used to divide quickly by 2^n . The setting of XER[CA] by the shift right algebraic instruction is independent of mode.

Multiple-precision shifts can be programmed as shown in Appendix C, “Multiple-Precision Shifts.”

The integer shift instructions are summarized in Table 4-5.

Table 4-5. Integer Shift Instructions

Name	Mnemonic	Operand Syntax	Operation
Shift Left Double Word (64-bit only)	sld sld.	rA,rS,rB	The contents of rS are shifted left the number of bits specified by the low-order seven bits of rB. Bits shifted out of position 0 are lost. Zeros are supplied to the vacated positions on the right. The result is placed into rA. Shift amounts from 64 to 127 give a zero result. sld Shift Left Double Word sld. Shift Left Double Word with CR Update. The dot suffix enables the update of the CR.
Shift Left Word	slw slw.	rA,rS,rB	The contents of the low-order 32 bits of rS are shifted left the number of bits specified by operand in the low-order six bits of rB. Bits shifted out of position 32 (position 0 in 32-bit implementations) are lost. Zeros are supplied to the vacated positions on the right. The 32-bit result is placed into the low-order 32 bits of rA. In a 64-bit implementation, the value in the high-order 32 bits of rA is cleared, and shift amounts from 32 to 63 give a zero result. slw Shift Left Word slw. Shift Left Word with CR Update. The dot suffix enables the update of the CR.
Shift Right Double Word (64-bit only)	srd srd.	rA,rS,rB	The contents of rS are shifted right the number of bits specified by the low-order seven bits of rB. Bits shifted out of position 63 are lost. Zeros are supplied to the vacated positions on the left. The result is placed into rA. Shift amounts from 64 to 127 give a zero result. srd Shift Right Double Word srd. Shift Right Double Word with CR Update. The dot suffix enables the update of the CR.
Shift Right Word	srw srw.	rA,rS,rB	The contents of the low-order 32 bits of rS are shifted right the number of bits specified by the low-order six bits of rB. Bits shifted out of position 63 (position 31 in 32-bit implementations) are lost. Zeros are supplied to the vacated positions on the left. The 32-bit result is placed into the low-order 32 bits of rA. In a 64-bit implementation, the value in the high-order 32 bits of rA is cleared to zero, and shift amounts from 32 to 63 give a zero result. srw Shift Right Word srw. Shift Right Word with CR Update. The dot suffix enables the update of the CR.
Shift Right Algebraic Double Word Immediate (64-bit only)	sradi sradi.	rA,rS,SH	The contents of rS are shifted right the number of bits specified by operand SH. Bits shifted out of position 63 are lost. Bit 0 of rS is replicated to fill the vacated positions on the left. The result is placed into rA. XER[CA] is set if rS contains a negative number and any 1 bits are shifted out of position 63; otherwise XER[CA] is cleared. An operand SH of zero causes rA to be loaded with the contents of rS and XER[CA] to be cleared to zero. sradi Shift Right Algebraic Double Word Immediate sradi. Shift Right Algebraic Double Word Immediate with CR Update. The dot suffix enables the update of the CR.

Table 4-5. Integer Shift Instructions (Continued)

Name	Mnemonic	Operand Syntax	Operation
Shift Right Algebraic Word Immediate	srawi srawi.	rA,rS,SH	The contents of the low-order 32 bits of rS are shifted right the number of bits specified by operand SH. Bits shifted out of position 63 (position 31 in 32-bit implementations) are lost. Bit 32 of rS is replicated to fill the vacated positions on the left for 64-bit implementations. The 32-bit result is sign extended and placed into the low-order 32 bits of rA. srawi Shift Right Algebraic Word Immediate srawi. Shift Right Algebraic Word Immediate with CR Update. The dot suffix enables the update of the CR.
Shift Right Algebraic Double Word (64-bit only)	srad srad.	rA,rS,rB	The contents of rS are shifted right the number of bits specified by the low-order seven bits of rB. Bits shifted out of position 63 are lost. Bit 0 of rS is replicated to fill the vacated positions on the left. The result is placed into rA. srad Shift Right Algebraic Double Word srad. Shift Right Algebraic Double Word with CR Update. The dot suffix enables the update of the CR.
Shift Right Algebraic Word	sraw sraw.	rA,rS,rB	The contents of the low-order 32 bits of rS are shifted right the number of bits specified by the low-order six bits of rB. Bits shifted out of position 63 (position 31 in 32-bit implementations) are lost. Bit 32 of rS is replicated to fill the vacated positions on the left for 64-bit implementations. The 32-bit result is placed into the low-order 32 bits of rA. sraw Shift Right Algebraic Word sraw. Shift Right Algebraic Word with CR Update. The dot suffix enables the update of the CR.

4.2.2 Floating-Point Instructions

This section describes the floating-point instructions, which include the following:

- Floating-point arithmetic instructions
- Floating-point multiply-add instructions
- Floating-point rounding and conversion instructions
- Floating-point compare instructions
- Floating-point status and control register instructions
- Floating-point move instructions

Note that MSR[FP] must be set in order for any of these instructions (including the floating-point loads and stores) to be executed. If MSR[FP] = 0 when any floating-point instruction is attempted, the floating-point unavailable exception is taken (see Section 6.4.8, “Floating-Point Unavailable Exception (0x00800)”). See Section 4.2.3, “Load and Store Instructions,” for information about floating-point loads and stores.

The PowerPC architecture supports a floating-point system as defined in the IEEE-754 standard, but requires software support to conform with that standard. Floating-point operations conform to the IEEE-754 standard, with the exception of operations performed with the **fmadd**, **fres**, **fsel**, and **frsqrite** instructions, or if software sets the non-IEEE mode bit (NI) in the FPSCR. Refer to Section 3.3, “Floating-Point Execution Models—UIA,”

for detailed information about the floating-point formats and exception conditions. Also, refer to Appendix D, “Floating-Point Models,” for more information on the floating-point execution models used by the PowerPC architecture.

4.2.2.1 Floating-Point Arithmetic Instructions

The floating-point arithmetic instructions are summarized in Table 4-6.

Table 4-6. Floating-Point Arithmetic Instructions

Name	Mnemonic	Operand Syntax	Operation
Floating Add (Double-Precision)	fadd fadd.	frD,frA,frB	The floating-point operand in register frA is added to the floating-point operand in register frB. If the most significant bit of the resultant significand is not a one the result is normalized. The result is rounded to the target precision under control of the floating-point rounding control field RN of the FPSCR and placed into register frD. fadd Floating Add (Double-Precision) fadd. Floating Add (Double-Precision) with CR Update. The dot suffix enables the update of the CR.
Floating Add Single	fadds fadds.	frD,frA,frB	The floating-point operand in register frA is added to the floating-point operand in register frB. If the most significant bit of the resultant significand is not a one, the result is normalized. The result is rounded to the target precision under control of the floating-point rounding control field RN of the FPSCR and placed into register frD. fadds Floating Add Single fadds. Floating Add Single with CR Update. The dot suffix enables the update of the CR.
Floating Subtract (Double-Precision)	fsub fsub.	frD,frA,frB	The floating-point operand in register frB is subtracted from the floating-point operand in register frA. If the most significant bit of the resultant significand is not 1, the result is normalized. The result is rounded to the target precision under control of the floating-point rounding control field RN of the FPSCR and placed into register frD. fsub Floating Subtract (Double-Precision) fsub. Floating Subtract (Double-Precision) with CR Update. The dot suffix enables the update of the CR.
Floating Subtract Single	fsubs fsubs.	frD,frA,frB	The floating-point operand in register frB is subtracted from the floating-point operand in register frA. If the most significant bit of the resultant significand is not 1, the result is normalized. The result is rounded to the target precision under control of the floating-point rounding control field RN of the FPSCR and placed into frD. fsubs Floating Subtract Single fsubs. Floating Subtract Single with CR Update. The dot suffix enables the update of the CR.
Floating Multiply (Double-Precision)	fmul fmul.	frD,frA,frC	The floating-point operand in register frA is multiplied by the floating-point operand in register frC. fmul Floating Multiply (Double-Precision) fmul. Floating Multiply (Double-Precision) with CR Update. The dot suffix enables the update of the CR.

Table 4-6. Floating-Point Arithmetic Instructions (Continued)

Name	Mnemonic	Operand Syntax	Operation
Floating Multiply Single	fmuls fmuls.	frD,frA,frC	The floating-point operand in register frA is multiplied by the floating-point operand in register frC. fmuls Floating Multiply Single fmuls. Floating Multiply Single with CR Update. The dot suffix enables the update of the CR.
Floating Divide (Double-Precision)	fdiv fdiv.	frD,frA,frB	The floating-point operand in register frA is divided by the floating-point operand in register frB. No remainder is preserved. fdiv Floating Divide (Double-Precision) fdiv. Floating Divide (Double-Precision) with CR Update. The dot suffix enables the update of the CR.
Floating Divide Single	fdivs fdivs.	frD,frA,frB	The floating-point operand in register frA is divided by the floating-point operand in register frB. No remainder is preserved. fdivs Floating Divide Single fdivs. Floating Divide Single with CR Update. The dot suffix enables the update of the CR.
Floating Square Root (Double-Precision)	fsqrt fsqrt.	frD,frB	The square root of the floating-point operand in register frB is placed into register frD. fsqrt Floating Square Root (Double-Precision) fsqrt. Floating Square Root (Double-Precision) with CR Update. The dot suffix enables the update of the CR. This instruction is optional.
Floating Square Root Single	fsqrts fsqrts.	frD,frB	The square root of the floating-point operand in register frB is placed into register frD. fsqrts Floating Square Root Single fsqrts. Floating Square Root Single with CR Update. The dot suffix enables the update of the CR. This instruction is optional.
Floating Reciprocal Estimate Single	fres fres.	frD,frB	A single-precision estimate of the reciprocal of the floating-point operand in register frB is placed into frD. The estimate placed into frD is correct to a precision of one part in 256 of the reciprocal of frB. fres Floating Reciprocal Estimate Single fres. Floating Reciprocal Estimate Single with CR Update. The dot suffix enables the update of the CR. This instruction is optional.
Floating Reciprocal Square Root Estimate	frsqrte frsqrte.	frD,frB	A double-precision estimate of the reciprocal of the square root of the floating-point operand in register frB is placed into frD. The estimate placed into frD is correct to a precision of one part in 32 of the reciprocal of the square root of frB. frsqrte Floating Reciprocal Square Root Estimate frsqrte. Floating Reciprocal Square Root estimate with CR Update. The dot suffix enables the update of the CR. This instruction is optional.

Table 4-6. Floating-Point Arithmetic Instructions (Continued)

Name	Mnemonic	Operand Syntax	Operation
Floating Select	fsel	frD,frA,frC,frB	<p>The floating-point operand in frA is compared to the value zero. If the operand is greater than or equal to zero, frD is set to the contents of frC. If the operand is less than zero or is a NaN, frD is set to the contents of frB. The comparison ignores the sign of zero (that is, regards +0 as equal to -0).</p> <p>fsel Floating Select fsel. Floating Select with CR Update. The dot suffix enables the update of the CR.</p> <p>This instruction is optional.</p>

4.2.2.2 Floating-Point Multiply-Add Instructions

These instructions combine multiply and add operations without an intermediate rounding operation. The fractional part of the intermediate product is 106 bits wide, and all 106 bits take part in the add/subtract portion of the instruction.

Status bits are set as follows:

- Overflow, underflow, and inexact exception bits, the FR and FI bits, and the FPRF field are set based on the final result of the operation, and not on the result of the multiplication.
- Invalid operation exception bits are set as if the multiplication and the addition were performed using two separate instructions (**fmuls**, followed by **fadds** or **fsubs**). That is, multiplication of infinity by zero or of anything by an SNaN, and/or addition of an SNaN, cause the corresponding exception bits to be set.

The floating-point multiply-add instructions are summarized in Table 4-7.

Table 4-7. Floating-Point Multiply-Add Instructions

Name	Mnemonic	Operand Syntax	Operation
Floating Multiply-Add (Double-Precision)	fmadd fmadd.	frD,frA,frC,frB	<p>The floating-point operand in register frA is multiplied by the floating-point operand in register frC. The floating-point operand in register frB is added to this intermediate result.</p> <p>fmadd Floating Multiply-Add (Double-Precision) fmadd. Floating Multiply-Add (Double-Precision) with CR Update. The dot suffix enables the update of the CR.</p>
Floating Multiply-Add Single	fmadds fmadds.	frD,frA,frC,frB	<p>The floating-point operand in register frA is multiplied by the floating-point operand in register frC. The floating-point operand in register frB is added to this intermediate result.</p> <p>fmadds Floating Multiply-Add Single fmadds. Floating Multiply-Add Single with CR Update. The dot suffix enables the update of the CR.</p>

Table 4-7. Floating-Point Multiply-Add Instructions (Continued)

Name	Mnemonic	Operand Syntax	Operation
Floating Multiply-Subtract (Double-Precision)	fmsub fmsub.	frD,frA,frC,frB	The floating-point operand in register frA is multiplied by the floating-point operand in register frC. The floating-point operand in register frB is subtracted from this intermediate result. fmsub Floating Multiply-Subtract (Double-Precision) fmsub. Floating Multiply-Subtract (Double-Precision) with CR Update. The dot suffix enables the update of the CR.
Floating Multiply-Subtract Single	fmsubs fmsubs.	frD,frA,frC,frB	The floating-point operand in register frA is multiplied by the floating-point operand in register frC. The floating-point operand in register frB is subtracted from this intermediate result. fmsubs Floating Multiply-Subtract Single fmsubs. Floating Multiply-Subtract Single with CR Update. The dot suffix enables the update of the CR.
Floating Negative Multiply-Add (Double-Precision)	fnmadd fnmadd.	frD,frA,frC,frB	The floating-point operand in register frA is multiplied by the floating-point operand in register frC. The floating-point operand in register frB is added to this intermediate result. fnmadd Floating Negative Multiply-Add (Double-Precision) fnmadd. Floating Negative Multiply-Add (Double-Precision) with CR Update. The dot suffix enables update of the CR.
Floating Negative Multiply-Add Single	fnmadds fnmadds.	frD,frA,frC,frB	The floating-point operand in register frA is multiplied by the floating-point operand in register frC. The floating-point operand in register frB is added to this intermediate result. fnmadds Floating Negative Multiply-Add Single fnmadds. Floating Negative Multiply-Add Single with CR Update. The dot suffix enables the update of the CR.
Floating Negative Multiply-Subtract (Double-Precision)	fnmsub fnmsub.	frD,frA,frC,frB	The floating-point operand in register frA is multiplied by the floating-point operand in register frC. The floating-point operand in register frB is subtracted from this intermediate result. fnmsub Floating Negative Multiply-Subtract (Double-Precision) fnmsub. Floating Negative Multiply-Subtract (Double-Precision) with CR Update. The dot suffix enables the update of the CR.
Floating Negative Multiply-Subtract Single	fnmsubs fnmsubs.	frD,frA,frC,frB	The floating-point operand in register frA is multiplied by the floating-point operand in register frC. The floating-point operand in register frB is subtracted from this intermediate result. fnmsubs Floating Negative Multiply-Subtract Single fnmsubs. Floating Negative Multiply-Subtract Single with CR Update. The dot suffix enables the update of the CR.

For more information on multiply-add instructions, refer to Section D.2, “Execution Model for Multiply-Add Type Instructions.”

4.2.2.3 Floating-Point Rounding and Conversion Instructions

The Floating Round to Single-Precision (**frsp**) instruction is used to truncate a 64-bit double-precision number to a 32-bit single-precision floating-point number. The floating-point convert instructions convert a 64-bit double-precision floating-point number to a 32-bit signed integer number.

The PowerPC architecture defines bits 0–31 of floating-point register **frD** as undefined when executing the Floating Convert to Integer Word (**fctiw**) and Floating Convert to Integer Word with Round toward Zero (**fctiwz**) instructions. The floating-point rounding instructions are shown in Table 4-8.

Examples of uses of these instructions to perform various conversions can be found in Appendix D, “Floating-Point Models.”

Table 4-8. Floating-Point Rounding and Conversion Instructions

Name	Mnemonic	Operand Syntax	Operation
Floating Round to Single-Precision	frsp frsp.	frD,frB	The floating-point operand in frB is rounded to single-precision using the rounding mode specified by FPSCR[RN] and placed into frD . frsp Floating Round to Single-Precision frsp. Floating Round to Single-Precision with CR Update. The dot suffix enables the update of the CR.
Floating Convert from Integer Double Word (64-bit only)	fctid fctid.	frD,frB	The 64-bit signed integer operand in frB is converted to an infinitely precise floating-point integer. The result of the conversion is rounded to double-precision using the rounding mode specified by FPSCR[RN] and placed into register frD . fctid Floating Convert from Integer Double Word fctid. Floating Convert from Integer Double Word with CR Update. The dot suffix enables the update of the CR.
Floating Convert to Integer Double Word (64-bit only)	fctid fctid.	frD,frB	The floating-point operand in register frB is converted to a 64-bit signed integer, using the rounding mode specified by FPSCR[RN], and placed in frD . fctiw Floating Convert to Integer Double Word fctiw. Floating Convert to Integer Double Word with CR Update. The dot suffix enables the update of the CR.
Floating Convert to Integer Double Word with Round toward Zero (64-bit only)	fctidz fctidz.	frD,frB	The floating-point operand in register frB is converted to a 64-bit signed integer, using the rounding mode Round toward Zero and placed in frD . fctidz Floating Convert to Integer Double Word with Round toward Zero fctidz. Floating Convert to Integer Double Word with Round toward Zero with CR Update. The dot suffix enables the update of the CR.
Floating Convert to Integer Word	fctiw fctiw.	frD,frB	The floating-point operand in register frB is converted to a 32-bit signed integer, using the rounding mode specified by FPSCR[RN], and placed in the low-order 32 bits of frD . Bits 0–31 of frD are undefined. fctiw Floating Convert to Integer Word fctiw. Floating Convert to Integer Word with CR Update. The dot suffix enables the update of the CR.
Floating Convert to Integer Word with Round toward Zero	fctiwz fctiwz.	frD,frB	The floating-point operand in register frB is converted to a 32-bit signed integer, using the rounding mode Round toward Zero, and placed in the low-order 32 bits of frD . Bits 0–31 of frD are undefined. fctiwz Floating Convert to Integer Word with Round toward Zero fctiwz. Floating Convert to Integer Word with Round toward Zero with CR Update. The dot suffix enables the update of the CR.

4.2.2.4 Floating-Point Compare Instructions

Floating-point compare instructions compare the contents of two floating-point registers and the comparison ignores the sign of zero (that is $+0 = -0$). The comparison can be ordered or unordered. The comparison sets one bit in the designated CR field and clears the other three bits. The FPCC (floating-point condition code) in bits 16–19 of the FPSCR (floating-point status and control register) is set in the same way.

The CR field and the FPCC are interpreted as shown in Table 4-9.

Table 4-9. CR Bit Settings

Bit	Name	Description
0	FL	(frA) < (frB)
1	FG	(frA) > (frB)
2	FE	(frA) = (frB)
3	FU	(frA) ? (frB) (unordered)

The floating-point compare instructions are summarized in Table 4-10.

Table 4-10. Floating-Point Compare Instructions

Name	Mnemonic	Operand Syntax	Operation
Floating Compare Unordered	fcmpu	crfD,frA,frB	The floating-point operand in frA is compared to the floating-point operand in frB. The result of the compare is placed into crfD and the FPCC.
Floating Compare Ordered	fcmpo	crfD,frA,frB	The floating-point operand in frA is compared to the floating-point operand in frB. The result of the compare is placed into crfD and the FPCC.

4.2.2.5 Floating-Point Status and Control Register Instructions

Every FPSCR instruction appears to synchronize the effects of all floating-point instructions executed by a given processor. Executing an FPSCR instruction ensures that all floating-point instructions previously initiated by the given processor appear to have completed before the FPSCR instruction is initiated and that no subsequent floating-point instructions appear to be initiated by the given processor until the FPSCR instruction has completed. In particular:

- All exceptions caused by the previously initiated instructions are recorded in the FPSCR before the FPSCR instruction is initiated.
- All invocations of the floating-point exception handler caused by the previously initiated instructions have occurred before the FPSCR instruction is initiated.
- No subsequent floating-point instruction that depends on or alters the settings of any FPSCR bits appears to be initiated until the FPSCR instruction has completed.

Floating-point memory access instructions are not affected by the execution of the FPSCR instructions.

The FPSCR instructions are summarized in Table 4-11.

Table 4-11. Floating-Point Status and Control Register Instructions

Name	Mnemonic	Operand Syntax	Operation
Move from FPSCR	mffs mffs.	frD	The contents of the FPSCR are placed into bits 32–63 of frD. Bits 0–31 of frD are undefined. mffs Move from FPSCR mffs. Move from FPSCR with CR Update. The dot suffix enables the update of the CR.
Move to Condition Register from FPSCR	mcrfs	crfD,crfS	The contents of FPSCR field specified by operand crfS are copied to the CR field specified by operand crfD. All exception bits copied (except FEX and VX bits) are cleared in the FPSCR.
Move to FPSCR Field Immediate	mtfsfi mtfsfi.	crfD,IMM	The contents of the IMM field are placed into FPSCR field crfD. The contents of FPSCR[FX] are altered only if crfD = 0. mtfsfi Move to FPSCR Field Immediate mtfsfi. Move to FPSCR Field Immediate with CR Update. The dot suffix enables the update of the CR.
Move to FPSCR Fields	mtfsf mtfsf.	FM,frB	Bits 32–63 of frB are placed into the FPSCR under control of the field mask specified by FM. The field mask identifies the 4-bit fields affected. Let <i>i</i> be an integer in the range 0–7. If FM[<i>i</i>] = 1, FPSCR field <i>i</i> (FPSCR bits 4* <i>i</i> through 4* <i>i</i> +3) is set to the contents of the corresponding field of the low-order 32 bits of frB. The contents of FPSCR[FX] are altered only if FM[0] = 1. mtfsf Move to FPSCR Fields mtfsf. Move to FPSCR Fields with CR Update. The dot suffix enables the update of the CR.
Move to FPSCR Bit 0	mtfsb0 mtfsb0.	crbD	The FPSCR bit location specified by operand crbD is cleared. Bits 1 and 2 (FEX and VX) cannot be reset explicitly. mtfsb0 Move to FPSCR Bit 0 mtfsb0. Move to FPSCR Bit 0 with CR Update. The dot suffix enables the update of the CR.
Move to FPSCR Bit 1	mtfsb1 mtfsb1.	crbD	The FPSCR bit location specified by operand crbD is set. Bits 1 and 2 (FEX and VX) cannot be set explicitly. mtfsb1 Move to FPSCR Bit 1 mtfsb1. Move to FPSCR Bit 1 with CR Update. The dot suffix enables the update of the CR.

4.2.2.6 Floating-Point Move Instructions

Floating-point move instructions copy data from one FPR to another, altering the sign bit (bit 0) as described for the **fneg**, **fabs**, and **fnabs** instructions in Table 4-12. The **fneg**, **fabs**, and **fnabs** instructions may alter the sign bit of a NaN. The floating-point move instructions do not modify the FPSCR. The CR update option in these instructions controls the placing of result status into CR1. If the CR update option is enabled, CR1 is set; otherwise, CR1 is unchanged.

Table 4-12 provides a summary of the floating-point move instructions.

Table 4-12. Floating-Point Move Instructions

Name	Mnemonic	Operand Syntax	Operation
Floating Move Register	fmr fmr.	frD,frB	The contents of frB are placed into frD. fmr Floating Move Register fmr. Floating Move Register with CR Update. The dot suffix enables the update of the CR.
Floating Negate	fneg fneg.	frD,frB	The contents of frB with bit 0 inverted are placed into frD. fneg Floating Negate fneg. Floating Negate with CR Update. The dot suffix enables the update of the CR.
Floating Absolute Value	fabs fabs.	frD,frB	The contents of frB with bit 0 cleared are placed into frD. fabs Floating Absolute Value fabs. Floating Absolute Value with CR Update. The dot suffix enables the update of the CR.
Floating Negative Absolute Value	fnabs fnabs.	frD,frB	The contents of frB with bit 0 set are placed into frD. fnabs Floating Negative Absolute Value fnabs. Floating Negative Absolute Value with CR Update. The dot suffix enables the update of the CR.

4.2.3 Load and Store Instructions

Load and store instructions are issued and translated in program order; however, the accesses can occur out of order. Synchronizing instructions are provided to enforce strict ordering. This section describes the load and store instructions, which consist of the following:

- Integer load instructions
- Integer store instructions
- Integer load and store with byte-reverse instructions
- Integer load and store multiple instructions
- Floating-point load instructions
- Floating-point store instructions
- Memory synchronization instructions

4.2.3.1 Integer Load and Store Address Generation

Integer load and store operations generate effective addresses using register indirect with immediate index mode, register indirect with index mode, or register indirect mode. See Section 4.1.4.2, “Effective Address Calculation,” for information about calculating effective addresses. Note that in some implementations, operations that are not naturally aligned may suffer performance degradation. Refer to Section 6.4.6.1, “Integer Alignment Exceptions,” for additional information about load and store address alignment exceptions.

4.2.3.1.1 Register Indirect with Immediate Index Addressing for Integer Loads and Stores

Instructions using this addressing mode contain a signed 16-bit immediate index (d operand) which is sign extended, and added to the contents of a general-purpose register specified in the instruction (rA operand) to generate the effective address. If the rA field of the instruction specifies r0, a value of zero is added to the immediate index (d operand) in place of the contents of r0. The option to specify rA or 0 is shown in the instruction descriptions as (rA|0).

Figure 4-1 shows how an effective address is generated when using register indirect with immediate index addressing.

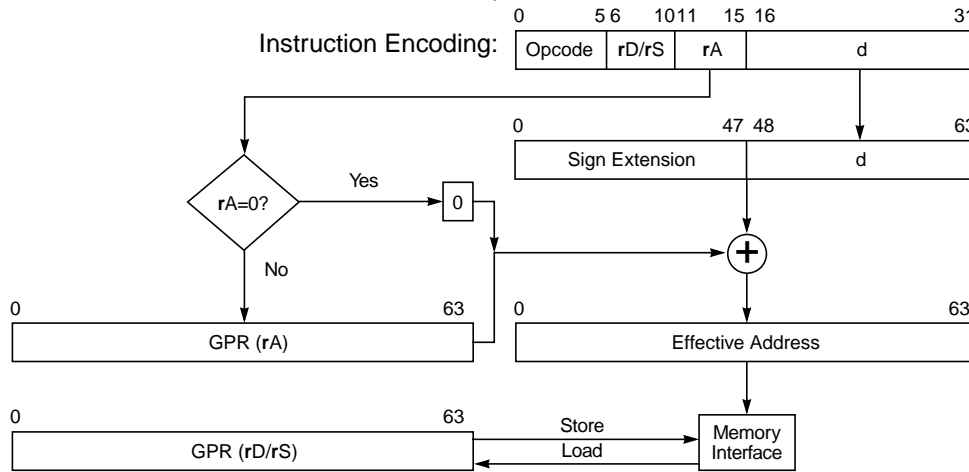

Figure 4-1. Register Indirect with Immediate Index Addressing for Integer Loads/Stores

4.2.3.1.2 Register Indirect with Index Addressing for Integer Loads and Stores

Instructions using this addressing mode cause the contents of two general-purpose registers (specified as operands **rA** and **rB**) to be added in the generation of the effective address. A zero in place of the **rA** operand causes a zero to be added to the contents of the general-purpose register specified in operand **rB** (or the value zero for **lswi** and **stswi** instructions). The option to specify **rA** or 0 is shown in the instruction descriptions as (**rA**|0).

Figure 4-2 shows how an effective address is generated when using register indirect with index addressing.

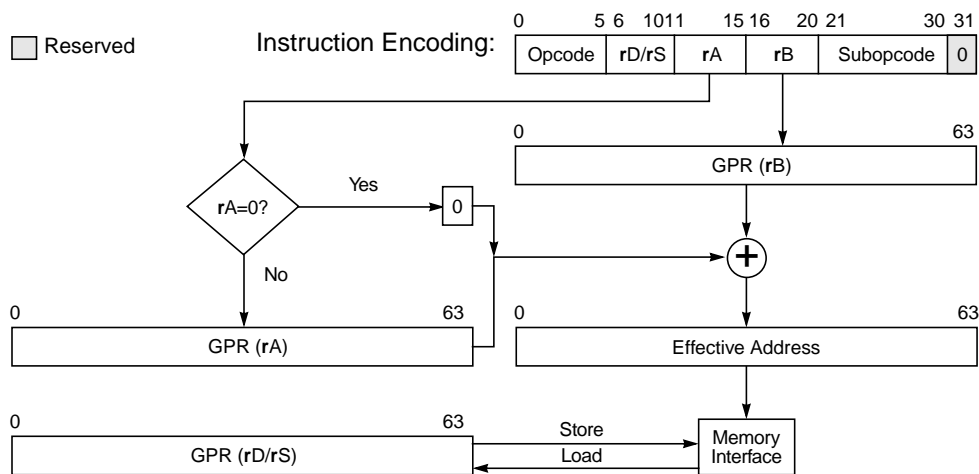

Figure 4-2. Register Indirect with Index Addressing for Integer Loads/Stores

4.2.3.1.3 Register Indirect Addressing for Integer Loads and Stores

Instructions using this addressing mode use the contents of the general-purpose register specified by the **rA** operand as the effective address. A zero in the **rA** operand causes an effective address of zero to be generated. The option to specify **rA** or 0 is shown in the instruction descriptions as (**rA**|0).

Figure 4-3 shows how an effective address is generated when using register indirect addressing.

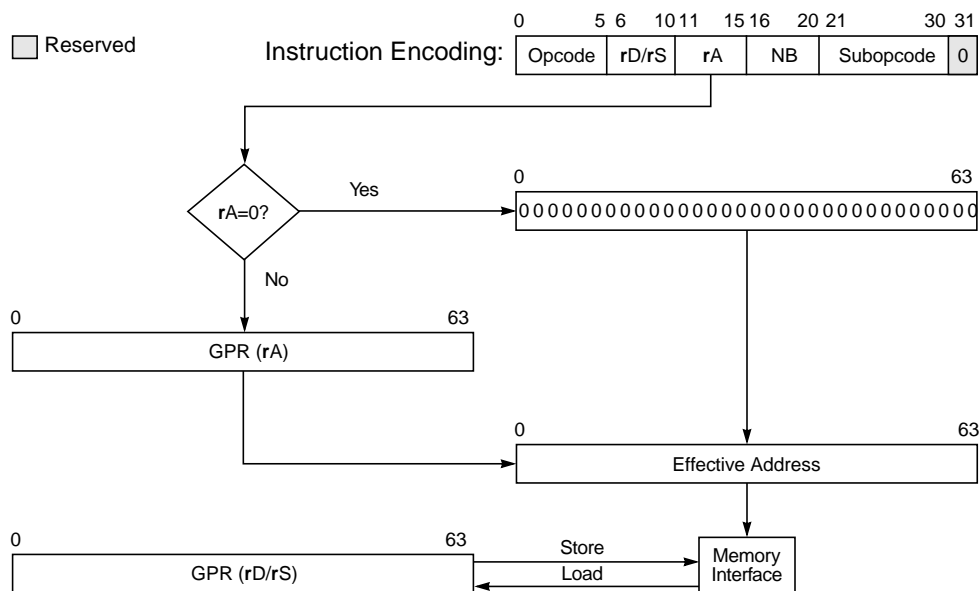

Figure 4-3. Register Indirect Addressing for Integer Loads/Stores

4.2.3.2 Integer Load Instructions

For integer load instructions, the byte, half word, word, or double word addressed by the EA (effective address) is loaded into **rD**. Many integer load instructions have an update form, in which **rA** is updated with the generated effective address. For these forms, if **rA** ≠ 0 and **rA** ≠ **rD** (otherwise invalid), the EA is placed into **rA** and the memory element (byte, half word, word, or double word) addressed by the EA is loaded into **rD**. Note that the PowerPC architecture defines load with update instructions with operand **rA** = 0 or **rA** = **rD** as invalid forms.

The default byte and bit ordering is big-endian in the PowerPC architecture; see Section 3.1.2, “Byte Ordering,” for information about little-endian byte ordering.

Note that in some implementations of the architecture, the load word algebraic instructions (**lha**, **lhax**, **lwa**, **lwax**) and the load with update (**lbzu**, **lbzux**, **lhzu**, **lhzux**, **lhau**, **lhaux**, **lwaux**, **ldu**, **ldux**) instructions may execute with greater latency than other types of load instructions. Moreover, the load with update instructions may take longer to execute in some implementations than the corresponding pair of a nonupdate load followed by an add instruction.

Table 4-13 summarizes the integer load instructions.

Table 4-13. Integer Load Instructions

Name	Mnemonic	Operand Syntax	Operation
Load Byte and Zero	lbz	rD,d(rA)	The EA is the sum (rA 0) + d. The byte in memory addressed by the EA is loaded into the low-order eight bits of rD. The remaining bits in rD are cleared.
Load Byte and Zero Indexed	lbzx	rD,rA,rB	The EA is the sum (rA 0) + (rB). The byte in memory addressed by the EA is loaded into the low-order eight bits of rD. The remaining bits in rD are cleared.
Load Byte and Zero with Update	lbzu	rD,d(rA)	The EA is the sum (rA) + d. The byte in memory addressed by the EA is loaded into the low-order eight bits of rD. The remaining bits in rD are cleared. The EA is placed into rA.
Load Byte and Zero with Update Indexed	lbzux	rD,rA,rB	The EA is the sum (rA) + (rB). The byte in memory addressed by the EA is loaded into the low-order eight bits of rD. The remaining bits in rD are cleared. The EA is placed into rA.
Load Half Word and Zero	lhz	rD,d(rA)	The EA is the sum (rA 0) + d. The half word in memory addressed by the EA is loaded into the low-order 16 bits of rD. The remaining bits in rD are cleared.
Load Half Word and Zero Indexed	lhzx	rD,rA,rB	The EA is the sum (rA 0) + (rB). The half word in memory addressed by the EA is loaded into the low-order 16 bits of rD. The remaining bits in rD are cleared.
Load Half Word and Zero with Update	lhzu	rD,d(rA)	The EA is the sum (rA) + d. The half word in memory addressed by the EA is loaded into the low-order 16 bits of rD. The remaining bits in rD are cleared. The EA is placed into rA.
Load Half Word and Zero with Update Indexed	lhzux	rD,rA,rB	The EA is the sum (rA) + (rB). The half word in memory addressed by the EA is loaded into the low-order 16 bits of rD. The remaining bits in rD are cleared. The EA is placed into rA.
Load Half Word Algebraic	lha	rD,d(rA)	The EA is the sum (rA 0) + d. The half word in memory addressed by the EA is loaded into the low-order 16 bits of rD. The remaining bits in rD are filled with a copy of the most significant bit of the loaded half word.
Load Half Word Algebraic Indexed	lhax	rD,rA,rB	The EA is the sum (rA 0) + (rB). The half word in memory addressed by the EA is loaded into the low-order 16 bits of rD. The remaining bits in rD are filled with a copy of the most significant bit of the loaded half word.
Load Half Word Algebraic with Update	lhau	rD,d(rA)	The EA is the sum (rA) + d. The half word in memory addressed by the EA is loaded into the low-order 16 bits of rD. The remaining bits in rD are filled with a copy of the most significant bit of the loaded half word. The EA is placed into rA.
Load Half Word Algebraic with Update Indexed	lhaux	rD,rA,rB	The EA is the sum (rA) + (rB). The half word in memory addressed by the EA is loaded into the low-order 16 bits of rD. The remaining bits in rD are filled with a copy of the most significant bit of the loaded half word. The EA is placed into rA.
Load Word and Zero	lwz	rD,d(rA)	The EA is the sum (rA 0) + d. The word in memory addressed by the EA is loaded into the low-order 32 bits of rD. The remaining bits in the high-order 32 bits of rD are cleared for 64-bit implementations.

Table 4-13. Integer Load Instructions (Continued)

Name	Mnemonic	Operand Syntax	Operation
Load Word and Zero Indexed	lwzx	rD,rA,rB	The EA is the sum (rA 0) + (rB). The word in memory addressed by the EA is loaded into the low-order 32 bits of rD. The remaining bits in the high-order 32 bits of rD are cleared for 64-bit implementations.
Load Word and Zero with Update	lwzu	rD,d(rA)	The EA is the sum (rA) + d. The word in memory addressed by the EA is loaded into the low-order 32 bits of rD. The remaining bits in the high-order 32 bits of rD are cleared for 64-bit implementations. The EA is placed into rA.
Load Word and Zero with Update Indexed	lwzux	rD,rA,rB	The EA is the sum (rA) + (rB). The word in memory addressed by the EA is loaded into the low-order 32 bits of rD. The remaining bits in the high-order 32 bits of rD are cleared for 64-bit implementations. The EA is placed into rA.
Load Word Algebraic (64-bit only)	lwa	rD,ds(rA)	The EA is the sum (rA 0) + (ds 0b00). The word in memory addressed by the EA is loaded into the low-order 32 bits of rD. The remaining bits in the high-order 32 bits of rD are filled with a copy of the most significant bit of the loaded word.
Load Word Algebraic Indexed (64-bit only)	lwax	rD,rA,rB	The EA is the sum (rA 0) + (rB). The word in memory addressed by the EA is loaded into the low-order 32 bits of rD. The remaining bits in the high-order 32 bits of rD are filled with a copy of the most significant bit of the loaded word.
Load Word Algebraic with Update Indexed (64-bit only)	lwaux	rD,rA,rB	The EA is the sum (rA) + (rB). The word in memory addressed by the EA is loaded into the low-order 32 bits of rD. The remaining bits in the high-order 32 bits of rD are filled with a copy of the most significant bit of the loaded word. The EA is placed into rA.
Load Double Word (64-bit only)	ld	rD,ds(rA)	The EA is the sum (rA 0) + (ds 0b00). The double word in memory addressed by the EA is loaded into rD.
Load Double Word Indexed (64-bit only)	ldx	rD,rA,rB	The EA is the sum (rA 0) + (rB). The double word in memory addressed by the EA is loaded into rD.
Load Double Word with Update (64-bit only)	ldu	rD,ds(rA)	The EA is the sum (rA) + (ds 0b00). The double word in memory addressed by the EA is loaded into rD. The EA is placed into rA.
Load Double Word with Update Indexed (64-bit only)	ldux	rD,rA,rB	The EA is the sum (rA) + (rB). The double word in memory addressed by the EA is loaded into rD. The EA is placed into rA.

4.2.3.3 Integer Store Instructions

For integer store instructions, the contents of **rS** are stored into the byte, half word, word or double word in memory addressed by the EA (effective address). Many store instructions have an update form, in which **rA** is updated with the EA. For these forms, the following rules apply:

- If **rA** ≠ 0, the effective address is placed into **rA**.
- If **rS** = **rA**, the contents of register **rS** are copied to the target memory element, then the generated EA is placed into **rA** (**rS**).

In general, the PowerPC architecture defines a sequential execution model. However, when a store instruction modifies a memory location that contains an instruction, software synchronization is required to ensure that subsequent instruction fetches from that location obtain the modified version of the instruction.

If a program modifies the instructions it intends to execute, it should call the appropriate system library program before attempting to execute the modified instructions to ensure that the modifications have taken effect with respect to instruction fetching.

The PowerPC architecture defines store with update instructions with $rA = 0$ as an invalid form. In addition, it defines integer store instructions with the CR update option enabled (Rc field, bit 31, in the instruction encoding = 1) to be an invalid form. Table 4-14 provides a summary of the integer store instructions.

Table 4-14. Integer Store Instructions

Name	Mnemonic	Operand Syntax	Operation
Store Byte	stb	$rS, d(rA)$	The EA is the sum $(rA 0) + d$. The contents of the low-order eight bits of rS are stored into the byte in memory addressed by the EA.
Store Byte Indexed	stbx	rS, rA, rB	The EA is the sum $(rA 0) + (rB)$. The contents of the low-order eight bits of rS are stored into the byte in memory addressed by the EA.
Store Byte with Update	stbu	$rS, d(rA)$	The EA is the sum $(rA) + d$. The contents of the low-order eight bits of rS are stored into the byte in memory addressed by the EA. The EA is placed into rA .
Store Byte with Update Indexed	stbux	rS, rA, rB	The EA is the sum $(rA) + (rB)$. The contents of the low-order eight bits of rS are stored into the byte in memory addressed by the EA. The EA is placed into rA .
Store Half Word	sth	$rS, d(rA)$	The EA is the sum $(rA 0) + d$. The contents of the low-order 16 bits of rS are stored into the half word in memory addressed by the EA.
Store Half Word Indexed	sthx	rS, rA, rB	The EA is the sum $(rA 0) + (rB)$. The contents of the low-order 16 bits of rS are stored into the half word in memory addressed by the EA.
Store Half Word with Update	sthu	$rS, d(rA)$	The EA is the sum $(rA) + d$. The contents of the low-order 16 bits of rS are stored into the half word in memory addressed by the EA. The EA is placed into rA .
Store Half Word with Update Indexed	sthux	rS, rA, rB	The EA is the sum $(rA) + (rB)$. The contents of the low-order 16 bits of rS are stored into the half word in memory addressed by the EA. The EA is placed into rA .
Store Word	stw	$rS, d(rA)$	The EA is the sum $(rA 0) + d$. The contents of the low-order 32 bits of rS are stored into the word in memory addressed by the EA.
Store Word Indexed	stwx	rS, rA, rB	The EA is the sum $(rA 0) + (rB)$. The contents of the low-order 32 bits of rS are stored into the word in memory addressed by the EA.
Store Word with Update	stwu	$rS, d(rA)$	The EA is the sum $(rA) + d$. The contents of the low-order 32 bits of rS are stored into the word in memory addressed by the EA. The EA is placed into rA .

Table 4-14. Integer Store Instructions (Continued)

Name	Mnemonic	Operand Syntax	Operation
Store Word with Update Indexed	stwux	rS,rA,rB	The EA is the sum (rA) + (rB). The contents of the low-order 32 bits of rS are stored into the word in memory addressed by the EA. The EA is placed into rA.
Store Double Word (64-bit only)	std	rS,ds(rA)	The EA is the sum (rA 0) + (ds 0b00). The contents of rS are stored into the double word in memory addressed by the EA.
Store Double Word Indexed (64-bit only)	stdx	rS,rA,rB	The EA is the sum (rA 0) + (rB). The contents of rS are stored into the double word in memory addressed by the EA.
Store Double Word with Update (64-bit only)	stdu	rS,ds(rA)	The EA is the sum (rA) + (ds 0b00). The contents of rS are stored into the double word in memory addressed by the EA. The EA is placed into rA.
Store Double Word with Update Indexed (64-bit only)	stdux	rS,rA,rB	The EA is the sum (rA) + (rB). The contents of rS are stored into the double word in memory addressed by the EA. The EA is placed into rA.

4.2.3.4 Integer Load and Store with Byte-Reverse Instructions

Table 4-15 describes integer load and store with byte-reverse instructions. Note that in some PowerPC implementations, load byte-reverse instructions may have greater latency than other load instructions.

When used in a PowerPC system operating with the default big-endian byte order, these instructions have the effect of loading and storing data in little-endian order. Likewise, when used in a PowerPC system operating with little-endian byte order, these instructions have the effect of loading and storing data in big-endian order. For more information about big-endian and little-endian byte ordering, see Section 3.1.2, “Byte Ordering.”

Table 4-15. Integer Load and Store with Byte-Reverse Instructions

Name	Mnemonic	Operand Syntax	Operation
Load Half Word Byte-Reverse Indexed	lhbrx	rD,rA,rB	The EA is the sum (rA 0) + (rB). The high-order eight bits of the half word addressed by the EA are loaded into the low-order eight bits of rD. The next eight higher-order bits of the half word in memory addressed by the EA are loaded into the next eight lower-order bits of rD. The remaining rD bits are cleared.
Load Word Byte-Reverse Indexed	lwbrx	rD,rA,rB	The EA is the sum (rA 0) + (rB). Bits 0–7 of the word in memory addressed by the EA are loaded into the low-order eight bits of rD. Bits 8–15 of the word in memory addressed by the EA are loaded into bits 48–55 of rD (bits 16–23 of rD in 32-bit implementations). Bits 16–23 of the word in memory addressed by the EA are loaded into bits 40–47 of rD (bits 8–15 in 32-bit implementations). Bits 24–31 of the word in memory addressed by the EA are loaded into bits 32–39 of rD (bits 0–7 in 32-bit implementations). The remaining bits in rD are cleared.

Table 4-15. Integer Load and Store with Byte-Reverse Instructions (Continued)

Name	Mnemonic	Operand Syntax	Operation
Store Half Word Byte-Reverse Indexed	sthbrx	rS,rA,rB	The EA is the sum (rA 0) + (rB). The contents of the low-order eight bits of rS are stored into the high-order eight bits of the half word in memory addressed by the EA. The contents of the next lower-order eight bits of rS are stored into the next eight higher-order bits of the half word in memory addressed by the EA.
Store Word Byte-Reverse Indexed	stwbrx	rS,rA,rB	The effective address is the sum (rA 0) + (rB). The contents of the low-order eight bits of rS are stored into bits 0–7 of the word in memory addressed by EA. The contents of the next eight lower-order bits of rS are stored into bits 8–15 of the word in memory addressed by the EA. The contents of the next eight lower-order bits of rS are stored into bits 16–23 of the word in memory addressed by the EA. The contents of the next eight lower-order bits of rS are stored into bits 24–31 of the word addressed by the EA.

4.2.3.5 Integer Load and Store Multiple Instructions

The load/store multiple instructions are used to move blocks of data to and from the GPRs. The load multiple and store multiple instructions may have operands that require memory accesses crossing a 4-Kbyte page boundary. As a result, these instructions may be interrupted by a DSI exception associated with the address translation of the second page. Table 4-16 summarizes the integer load and store multiple instructions.

In the load/store multiple instructions, the combination of the EA and rD (rS) is such that the low-order byte of GPR31 is loaded from or stored into the last byte of an aligned quad word in memory; if the effective address is not correctly aligned, it may take significantly longer to execute.

In some PowerPC implementations operating with little-endian byte order, execution of an **lmw** or **stmw** instruction causes the system alignment error handler to be invoked; see Section 3.1.2, “Byte Ordering,” for more information.

The PowerPC architecture defines the load multiple word (**lmw**) instruction with rA in the range of registers to be loaded, including the case in which rA = 0, as an invalid form.

Table 4-16. Integer Load and Store Multiple Instructions

Name	Mnemonic	Operand Syntax	Operation
Load Multiple Word	lmw	rD,d(rA)	The EA is the sum (rA 0) + d. $n = (32 - rD)$.
Store Multiple Word	stmw	rS,d(rA)	The EA is the sum (rA 0) + d. $n = (32 - rS)$.

4.2.3.6 Integer Load and Store String Instructions

The integer load and store string instructions allow movement of data from memory to registers or from registers to memory without concern for alignment. These instructions can be used for a short move between arbitrary memory locations or to initiate a long move between misaligned memory fields. However, in some implementations, these instructions are likely to have greater latency and take longer to execute, perhaps much longer, than a sequence of individual load or store instructions that produce the same results. Table 4-17 summarizes the integer load and store string instructions.

Load and store string instructions execute more efficiently when rD or $rS = 5$, and the last register loaded or stored is less than or equal to 12.

In some PowerPC implementations operating with little-endian byte order, execution of a load or string instruction causes the system alignment error handler to be invoked; see Section 3.1.2, “Byte Ordering,” for more information.

Table 4-17. Integer Load and Store String Instructions

Name	Mnemonic	Operand Syntax	Operation
Load String Word Immediate	lswi	rD, rA, NB	The EA is $(rA 0)$.
Load String Word Indexed	lswx	rD, rA, rB	The EA is the sum $(rA 0) + (rB)$.
Store String Word Immediate	stswi	rS, rA, NB	The EA is $(rA 0)$.
Store String Word Indexed	stswx	rS, rA, rB	The EA is the sum $(rA 0) + (rB)$.

Load string and store string instructions may involve operands that are not word-aligned. As described in Section 6.4.6, “Alignment Exception (0x00600),” a misaligned string operation suffers a performance penalty compared to an aligned operation of the same type. A non-word-aligned string operation that crosses a double-word boundary is also slower than a word-aligned string operation.

4.2.3.7 Floating-Point Load and Store Address Generation

Floating-point load and store operations generate effective addresses using the register indirect with immediate index addressing mode and register indirect with index addressing mode. Floating-point loads and stores are not supported for direct-store interface accesses. The use of floating-point loads and stores for direct-store interface accesses results in an alignment exception. Note that the direct-store facility is being phased out of the architecture and is not likely to be supported in future devices.

4.2.3.7.1 Register Indirect with Immediate Index Addressing for Floating-Point Loads and Stores

Instructions using this addressing mode contain a signed 16-bit immediate index (d operand) which is sign extended to 64 bits, and added to the contents of a GPR specified in the instruction (rA operand) to generate the effective address. If the rA field of the instruction specifies r0, a value of zero is added to the immediate index (d operand) in place of the contents of r0. The option to specify rA or 0 is shown in the instruction descriptions as (rA|0).

Figure 4-4 shows how an effective address is generated when using register indirect with immediate index addressing for floating-point loads and stores.

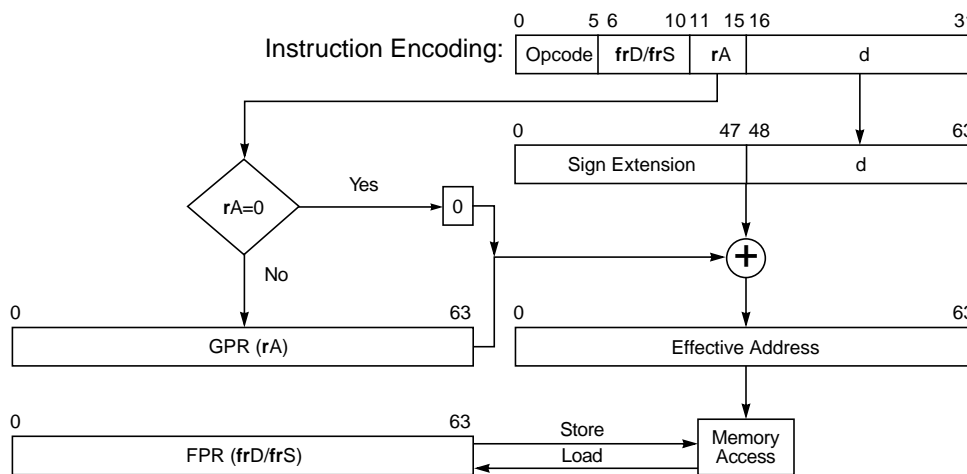

Figure 4-4. Register Indirect with Immediate Index Addressing for Floating-Point Loads/Stores

4.2.3.7.2 Register Indirect with Index Addressing for Floating-Point Loads and Stores

Instructions using this addressing mode add the contents of two GPRs (specified in operands rA and rB) to generate the effective address. A zero in the rA operand causes a zero to be added to the contents of the GPR specified in operand rB. This is shown in the instruction descriptions as (rA|0).

Figure 4-5 shows how an effective address is generated when using register indirect with index addressing.

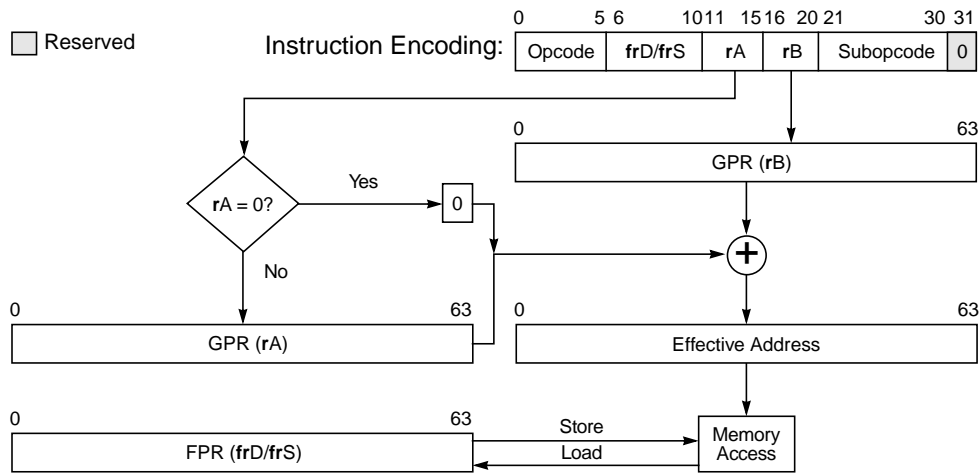

Figure 4-5. Register Indirect with Index Addressing for Floating-Point Loads/Stores

The PowerPC architecture defines floating-point load and store with update instructions (**lfsu**, **lfsux**, **lfdu**, **lfdux**, **stfsu**, **stfsux**, **stfdu**, **stfdx**) with operand **rA** = 0 as invalid forms of the instructions. In addition, it defines floating-point load and store instructions with the CR updating option enabled (**Rc** bit, bit 31 = 1) to be an invalid form.

The PowerPC architecture defines that the **FPSCR[UE]** bit should not be used to determine whether denormalization should be performed on floating-point stores.

4.2.3.8 Floating-Point Load Instructions

There are two forms of the floating-point load instruction—single-precision and double-precision operand formats. Because the FPRs support only the floating-point double-precision format, single-precision floating-point load instructions convert single-precision data to double-precision format before loading the operands into the target FPR. This conversion is described fully in Section D.6, “Floating-Point Load Instructions.” Table 4-18 provides a summary of the floating-point load instructions.

Note that the PowerPC architecture defines load with update instructions with **rA** = 0 as an invalid form.

Table 4-18. Floating-Point Load Instructions

Name	Mnemonic	Operand Syntax	Operation
Load Floating-Point Single	lfs	frD,d(rA)	The EA is the sum (rA 0) + d. The word in memory addressed by the EA is interpreted as a floating-point single-precision operand. This word is converted to floating-point double-precision format and placed into frD.

Table 4-18. Floating-Point Load Instructions (Continued)

Name	Mnemonic	Operand Syntax	Operation
Load Floating-Point Single Indexed	lfsx	frD,rA,rB	The EA is the sum $(rA 0) + (rB)$. The word in memory addressed by the EA is interpreted as a floating-point single-precision operand. This word is converted to floating-point double-precision format and placed into frD .
Load Floating-Point Single with Update	lfsu	frD,d(rA)	The EA is the sum $(rA) + d$. The word in memory addressed by the EA is interpreted as a floating-point single-precision operand. This word is converted to floating-point double-precision format and placed into frD . The EA is placed into the register specified by rA .
Load Floating-Point Single with Update Indexed	lfsux	frD,rA,rB	The EA is the sum $(rA) + (rB)$. The word in memory addressed by the EA is interpreted as a floating-point single-precision operand. This word is converted to floating-point double-precision format and placed into frD . The EA is placed into the register specified by rA .
Load Floating-Point Double	lfd	frD,d(rA)	The EA is the sum $(rA 0) + d$. The double word in memory addressed by the EA is placed into register frD .
Load Floating-Point Double Indexed	lfdx	frD,rA,rB	The EA is the sum $(rA 0) + (rB)$. The double word in memory addressed by the EA is placed into register frD .
Load Floating-Point Double with Update	lfdu	frD,d(rA)	The EA is the sum $(rA) + d$. The double word in memory addressed by the EA is placed into register frD . The EA is placed into the register specified by rA .
Load Floating-Point Double with Update Indexed	lfdux	frD,rA,rB	The EA is the sum $(rA) + (rB)$. The double word in memory addressed by the EA is placed into register frD . The EA is placed into the register specified by rA .

4.2.3.9 Floating-Point Store Instructions

This section describes floating-point store instructions. There are three basic forms of the store instruction—single-precision, double-precision, and integer. The integer form is supported by the **stfiwx** instruction. (Note that the **stfiwx** instruction is defined as optional by the PowerPC architecture to ensure backwards compatibility with earlier processors; however, it will likely be required for subsequent PowerPC processors.) Because the FPRs support only floating-point, double-precision format for floating-point data, single-precision floating-point store instructions convert double-precision data to single-precision format before storing the operands. The conversion steps are described fully in Section D.7, “Floating-Point Store Instructions.” Table 4-19 provides a summary of the floating-point store instructions.

Note that the PowerPC architecture defines store with update instructions with **rA = 0** as an invalid form.

Table 4-19 provides the floating-point store instructions for the PowerPC processors.

Table 4-19. Floating-Point Store Instructions

Name	Mnemonic	Operand Syntax	Operation
Store Floating-Point Single	stfs	frS,d(rA)	The EA is the sum (rA 0) + d. The contents of frS are converted to single-precision and stored into the word in memory addressed by the EA.
Store Floating-Point Single Indexed	stfsx	frS,rA,rB	The EA is the sum (rA 0) + (rB). The contents of frS are converted to single-precision and stored into the word in memory addressed by the EA.
Store Floating-Point Single with Update	stfsu	frS,d(rA)	The EA is the sum (rA) + d. The contents of frS are converted to single-precision and stored into the word in memory addressed by the EA. The EA is placed into rA.
Store Floating-Point Single with Update Indexed	stfsux	frS,rA,rB	The EA is the sum (rA) + (rB). The contents of frS are converted to single-precision and stored into the word in memory addressed by the EA. The EA is placed into the rA.
Store Floating-Point Double	stfd	frS,d(rA)	The EA is the sum (rA 0) + d. The contents of frS are stored into the double word in memory addressed by the EA.
Store Floating-Point Double Indexed	stfdx	frS,rA,rB	The EA is the sum (rA 0) + (rB). The contents of frS are stored into the double word in memory addressed by the EA.
Store Floating-Point Double with Update	stfdu	frS,d(rA)	The EA is the sum (rA) + d. The contents of frS are stored into the double word in memory addressed by the EA. The EA is placed into rA.
Store Floating-Point Double with Update Indexed	stfdux	frS,rA,rB	The EA is the sum (rA) + (rB). The contents of frS are stored into the double word in memory addressed by EA. The EA is placed into register rA.
Store Floating-Point as Integer Word Indexed	stfiwx	frS,rA,rB	The EA is the sum (rA 0) + (rB). The contents of the low-order 32 bits of frS are stored, without conversion, into the word in memory addressed by the EA. Note: The stfiwx instruction is defined as optional by the PowerPC architecture to ensure backwards compatibility with earlier processors; however, it will likely be required for subsequent PowerPC processors.

4.2.4 Branch and Flow Control Instructions

Some branch instructions can redirect instruction execution conditionally based on the value of bits in the CR. When the processor encounters one of these instructions, it scans the execution pipelines to determine whether an instruction in progress may affect the particular CR bit. If no interlock is found, the branch can be resolved immediately by checking the bit in the CR and taking the action defined for the branch instruction.

If an interlock is detected, the branch is considered unresolved and the direction of the branch may either be predicted using the *y* bit (as described in Table 4-20) or by using dynamic prediction. The interlock is monitored while instructions are fetched for the predicted branch. When the interlock is cleared, the processor determines whether the prediction was correct based on the value of the CR bit. If the prediction is correct, the branch is considered completed and instruction fetching continues. If the prediction is incorrect, the fetched instructions are purged, and instruction fetching continues along the alternate path.

4.2.4.1 Branch Instruction Address Calculation

Branch instructions can alter the sequence of instruction execution. Instruction addresses are always assumed to be word aligned; the PowerPC processors ignore the two low-order bits of the generated branch target address.

Branch instructions compute the effective address (EA) of the next instruction address using the following addressing modes:

- Branch relative
- Branch conditional to relative address
- Branch to absolute address
- Branch conditional to absolute address
- Branch conditional to link register
- Branch conditional to count register

In the 32-bit mode of a 64-bit implementation, the final step in the address computation is clearing the high-order 32 bits of the target address.

4.2.4.1.1 Branch Relative Addressing Mode

Instructions that use branch relative addressing generate the next instruction address by sign extending and appending 0b00 to the immediate displacement operand *LI*, and adding the resultant value to the current instruction address. Branches using this addressing mode have the absolute addressing option disabled (*AA* field, bit 30, in the instruction encoding = 0). The link register (*LR*) update option can be enabled (*LK* field, bit 31, in the instruction encoding = 1). This option causes the effective address of the instruction following the branch instruction to be placed in the *LR*.

Figure 4-6 shows how the branch target address is generated when using the branch relative addressing mode.

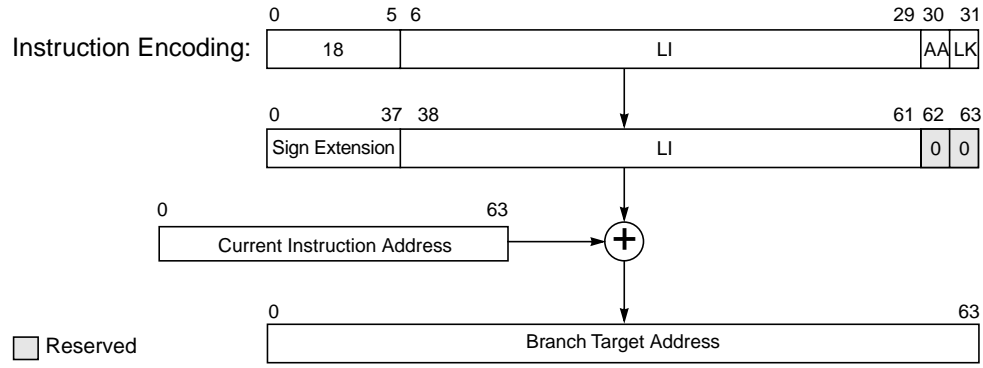

Figure 4-6. Branch Relative Addressing

4.2.4.1.2 Branch Conditional to Relative Addressing Mode

If the branch conditions are met, instructions that use the branch conditional to relative addressing mode generate the next instruction address by sign extending and appending 0b00 to the immediate displacement operand (BD) and adding the resultant value to the current instruction address. Branches using this addressing mode have the absolute addressing option disabled (AA field, bit 30, in the instruction encoding = 0). The link register update option can be enabled (LK field, bit 31, in the instruction encoding = 1). This option causes the effective address of the instruction following the branch instruction to be placed in the LR.

Figure 4-7 shows how the branch target address is generated when using the branch conditional relative addressing mode.

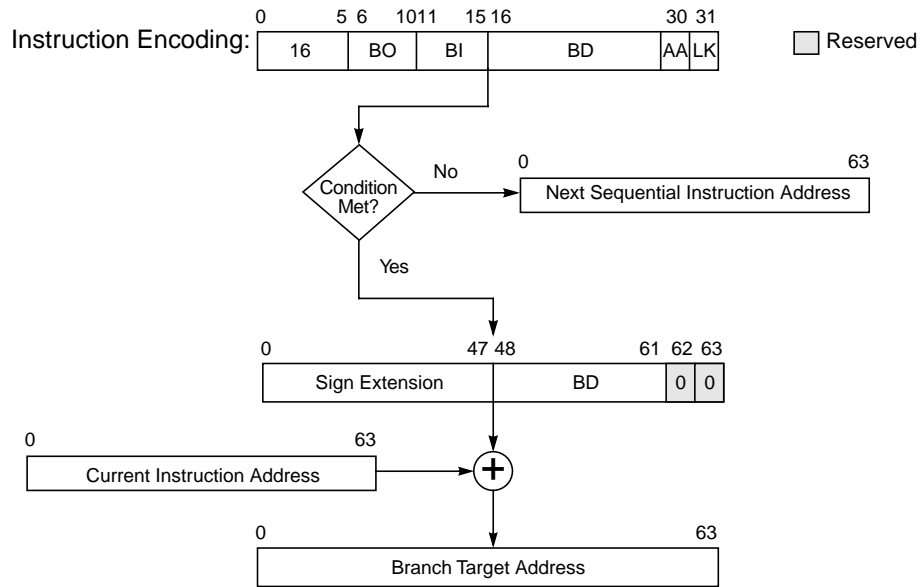

Figure 4-7. Branch Conditional Relative Addressing

4.2.4.1.3 Branch to Absolute Addressing Mode

Instructions that use branch to absolute addressing mode generate the next instruction address by sign extending and appending 0b00 to the LI operand. Branches using this addressing mode have the absolute addressing option enabled (AA field, bit 30, in the instruction encoding = 1). The link register update option can be enabled (LK field, bit 31, in the instruction encoding = 1). This option causes the effective address of the instruction following the branch instruction to be placed in the LR.

Figure 4-8 shows how the branch target address is generated when using the branch to absolute addressing mode.

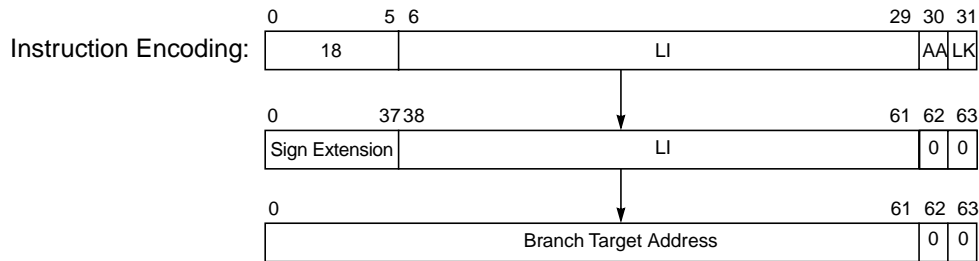

Figure 4-8. Branch to Absolute Addressing

4.2.4.1.4 Branch Conditional to Absolute Addressing Mode

If the branch conditions are met, instructions that use the branch conditional to absolute addressing mode generate the next instruction address by sign extending and appending 0b00 to the BD operand. Branches using this addressing mode have the absolute addressing option enabled (AA field, bit 30, in the instruction encoding = 1). The link register update option can be enabled (LK field, bit 31, in the instruction encoding = 1). This option causes the effective address of the instruction following the branch instruction to be placed in the LR.

Figure 4-9 shows how the branch target address is generated when using the branch conditional to absolute addressing mode.

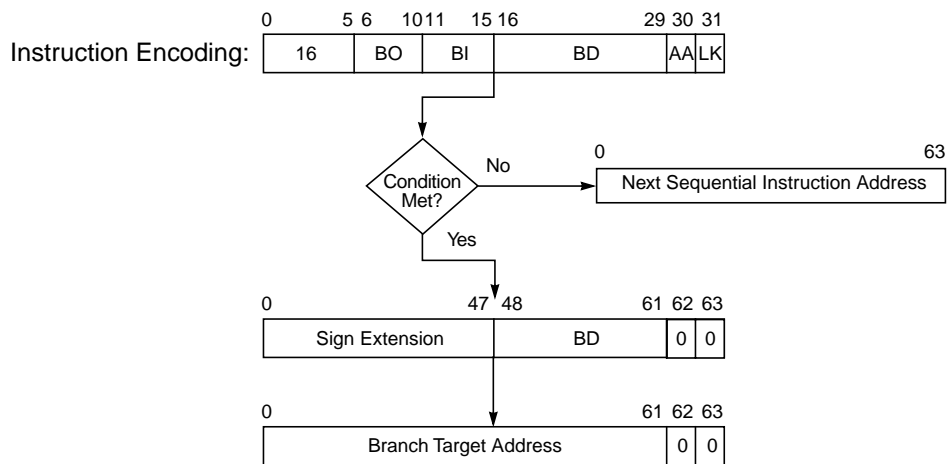

Figure 4-9. Branch Conditional to Absolute Addressing

4.2.4.1.5 Branch Conditional to Link Register Addressing Mode

If the branch conditions are met, the branch conditional to link register instruction generates the next instruction address by fetching the contents of the LR and clearing the two low-order bits to zero. The link register update option can be enabled (LK field, bit 31, in the instruction encoding = 1). This option causes the effective address of the instruction following the branch instruction to be placed in the LR.

Figure 4-10 shows how the branch target address is generated when using the branch conditional to link register addressing mode.

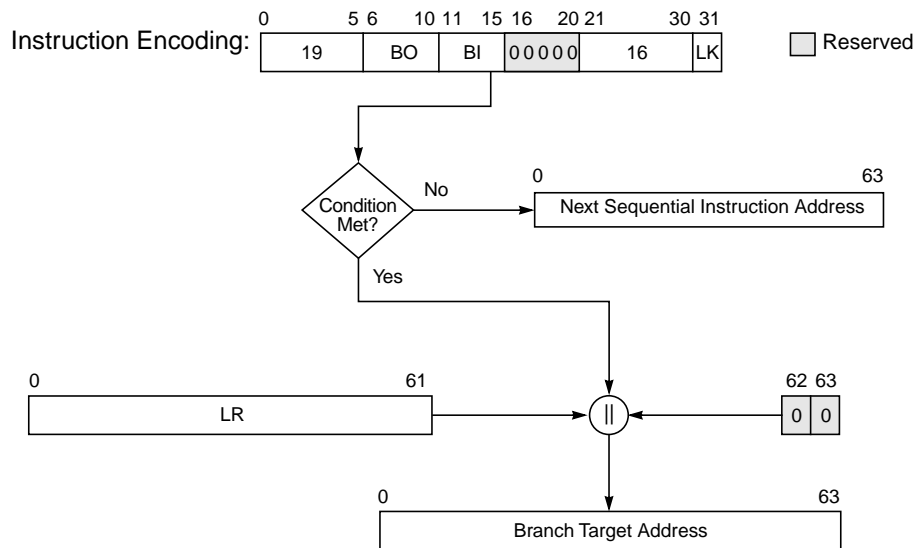

Figure 4-10. Branch Conditional to Link Register Addressing

4.2.4.1.6 Branch Conditional to Count Register Addressing Mode

If the branch conditions are met, the branch conditional to count register instruction generates the next instruction address by fetching the contents of the count register (CTR) and clearing the two low-order bits to zero. The link register update option can be enabled (LK field, bit 31, in the instruction encoding = 1). This option causes the effective address of the instruction following the branch instruction to be placed in the LR.

Figure 4-11 shows how the branch target address is generated when using the branch conditional to count register addressing mode.

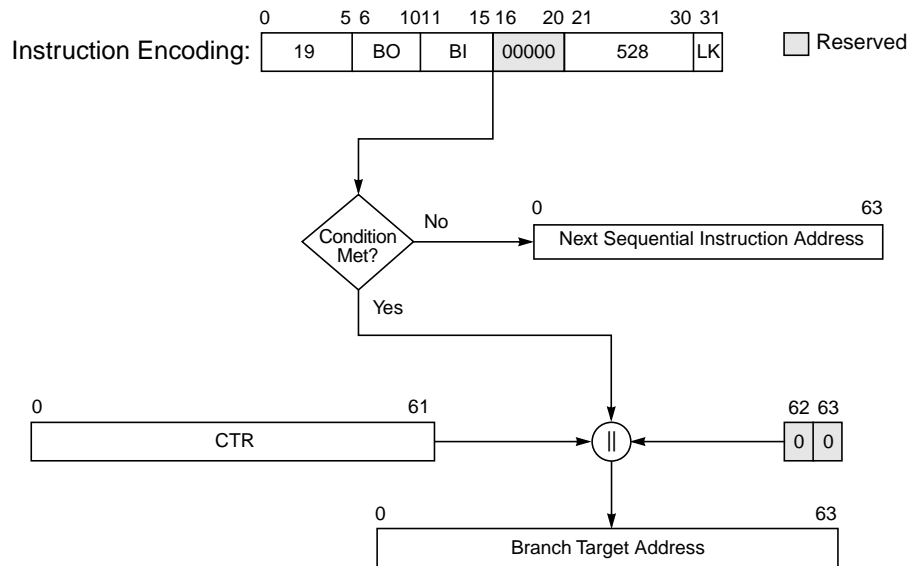

Figure 4-11. Branch Conditional to Count Register Addressing

4.2.4.2 Conditional Branch Control

For branch conditional instructions, the BO operand specifies the conditions under which the branch is taken. The first four bits of the BO operand specify how the branch is affected by or affects the condition and count registers. The fifth bit, shown in Table 4-20 as having the value *y*, is used by some PowerPC implementations for branch prediction as described below.

The encodings for the BO operands are shown in Table 4-20. *M* = 32 in 32-bit mode (of a 64-bit implementation) and *M* = 0 in the default 64-bit mode. If the BO field specifies that the CTR is to be decremented, the entire 64-bit CTR is decremented regardless of the 32-bit mode or the default 64-bit mode.

Table 4-20. BO Operand Encodings

BO	Description
0000 <i>y</i>	Decrement the CTR, then branch if the decremented CTR[M-63] ≠ 0 and the condition is FALSE.
0001 <i>y</i>	Decrement the CTR, then branch if the decremented CTR[M-63] = 0 and the condition is FALSE.
001 <i>zy</i>	Branch if the condition is FALSE.
0100 <i>y</i>	Decrement the CTR, then branch if the decremented CTR[M-63] ≠ 0 and the condition is TRUE.
0101 <i>y</i>	Decrement the CTR, then branch if the decremented CTR[M-63] = 0 and the condition is TRUE.
011 <i>zy</i>	Branch if the condition is TRUE.
1 <i>z</i> 00 <i>y</i>	Decrement the CTR, then branch if the decremented CTR[M-63] ≠ 0.

Table 4-20. BO Operand Encodings (Continued)

BO	Description
1z01y	Decrement the CTR, then branch if the decremented CTR[M-63] = 0.
1z1zz	Branch always.

In this table, z indicates a bit that is ignored.

Note that the z bits should be cleared, as they may be assigned a meaning in some future version of the PowerPC architecture.

The y bit provides a hint about whether a conditional branch is likely to be taken, and may be used by some PowerPC implementations to improve performance.

The branch always encoding of the BO operand does not have a y bit.

Clearing the y bit indicates a predicted behavior for the branch instruction as follows:

- For **bcx** with a negative value in the displacement operand, the branch is taken.
- In all other cases (**bcx** with a non-negative value in the displacement operand, **bclrx**, or **bcctrx**), the branch is not taken.

Setting the y bit reverses the preceding indications.

The sign of the displacement operand is used as described above even if the target is an absolute address. The default value for the y bit should be 0, and should only be set to 1 if software has determined that the prediction corresponding to y = 1 is more likely to be correct than the prediction corresponding to y = 0. Software that does not compute branch predictions should clear the y bit.

In most cases, the branch should be predicted to be taken if the value of the following expression is 1, and predicted to fall through if the value is 0.

$$((BO[0] \& BO[2]) | S) \approx BO[4]$$

In the expression above, S (bit 16 of the branch conditional instruction coding) is the sign bit of the displacement operand if the instruction has a displacement operand and is 0 if the operand is reserved. BO[4] is the y bit, or 0 for the branch always encoding of the BO operand. (Advantage is taken of the fact that, for **bclrx** and **bcctrx**, bit 16 of the instruction is part of a reserved operand and therefore must be 0.)

The 5-bit BI operand in branch conditional instructions specifies which of the 32 bits in the CR represents the condition to test.

When the branch instructions contain immediate addressing operands, the target addresses can be computed sufficiently ahead of the branch instruction that instructions can be fetched along the target path. If the branch instructions use the link and count registers, instructions along the target path can be fetched if the link or count register is loaded sufficiently ahead of the branch instruction.

Branching can be conditional or unconditional, and optionally a branch return address is created by the access of the effective address of the instruction following the branch instruction in the LR after the branch target address has been computed. This is done regardless of whether the branch is taken. Some processors may keep a stack of the link register values most recently set by branch and link instructions, with the possible exception of the form shown below for obtaining the address of the next instruction. To benefit from this stack, the following programming conventions should be used.

In the following examples, let A, B, and Glue represent subroutine labels:

- Obtaining the address of the next instruction—use the following form of branch and link:
bcl 20,31,\$+4
- Loop counts:
Keep them in the count register, and use one of the branch conditional instructions to decrement the count and to control branching (for example, branching back to the start of a loop if the decremented counter value is nonzero).
- Computed GOTOs, case statements, etc.:
Use the count register to hold the address to branch to, and use the **bcctr** instruction with the link register option disabled (LK = 0) to branch to the selected address.
- Direct subroutine linkage—where A calls B and B returns to A. The two branches should be as follows:
 - A calls B: use a branch instruction that enables the link register (LK = 1).
 - B returns to A: use the **bclr** instruction with the link register option disabled (LK = 0) (the return address is in, or can be restored to, the link register).
- Indirect subroutine linkage:
Where A calls Glue, Glue calls B, and B returns to A rather than to Glue. (Such a calling sequence is common in linkage code used when the subroutine that the programmer wants to call, here B, is in a different module from the caller: the binder inserts “glue” code to mediate the branch.) The three branches should be as follows:
 - A calls Glue: use a branch instruction that sets the link register with the link register option enabled (LK = 1).
 - Glue calls B: place the address of B in the count register, and use the **bcctr** instruction with the link register option disabled (LK = 0).
 - B returns to A: use the **bclr** instruction with the link register option disabled (LK = 0) (the return address is in, or can be restored to, the link register).

4.2.4.3 Branch Instructions

Table 4-21 describes the branch instructions provided by the PowerPC processors.

Table 4-21. Branch Instructions

Name	Mnemonic	Operand Syntax	Operation
Branch	b ba bl bla	target_addr	<p>b Branch. Branch to the address computed as the sum of the immediate address and the address of the current instruction.</p> <p>ba Branch Absolute. Branch to the absolute address specified.</p> <p>bl Branch then Link. Branch to the address computed as the sum of the immediate address and the address of the current instruction. The instruction address following this instruction is placed into the link register (LR).</p> <p>bla Branch Absolute then Link. Branch to the absolute address specified. The instruction address following this instruction is placed into the LR.</p>
Branch Conditional	bc bca bcl bcla	BO,BI,target_addr	<p>The BI operand specifies the bit in the CR to be used as the condition of the branch. The BO operand is used as described in Table 4-20.</p> <p>bc Branch Conditional. Branch conditionally to the address computed as the sum of the immediate address and the address of the current instruction.</p> <p>bca Branch Conditional Absolute. Branch conditionally to the absolute address specified.</p> <p>bcl Branch Conditional then Link. Branch conditionally to the address computed as the sum of the immediate address and the address of the current instruction. The instruction address following this instruction is placed into the LR.</p> <p>bcla Branch Conditional Absolute then Link. Branch conditionally to the absolute address specified. The instruction address following this instruction is placed into the LR.</p>
Branch Conditional to Link Register	bclr bclrl	BO,BI	<p>The BI operand specifies the bit in the CR to be used as the condition of the branch. The BO operand is used as described in Table 4-20, and the branch target address is LR[0–61] 0b00, with the high-order 32 bits of the branch target address cleared in the 32-bit mode of a 64-bit implementation.</p> <p>bclr Branch Conditional to Link Register. Branch conditionally to the address in the LR.</p> <p>bclrl Branch Conditional to Link Register then Link. Branch conditionally to the address specified in the LR. The instruction address following this instruction is then placed into the LR.</p>
Branch Conditional to Count Register	bcctr bcctrl	BO,BI	<p>The BI operand specifies the bit in the CR to be used as the condition of the branch. The BO operand is used as described in Table 4-20, and the branch target address is CTR[0–61] 0b00, with the high-order 32 bits of the branch target address cleared in the 32-bit mode of a 64-bit implementation.</p> <p>bcctr Branch Conditional to Count Register. Branch conditionally to the address specified in the count register.</p> <p>bcctrl Branch Conditional to Count Register then Link. Branch conditionally to the address specified in the count register. The instruction address following this instruction is placed into the LR.</p> <p>Note: If the “decrement and test CTR” option is specified (BO[2] = 0), the instruction form is invalid.</p>

4.2.4.4 Simplified Mnemonics for Branch Processor Instructions

To simplify assembly language programming, a set of simplified mnemonics and symbols is provided for the most frequently used forms of branch conditional, compare, trap, rotate and shift, and certain other instructions. See Appendix F, “Simplified Mnemonics,” for a list of simplified mnemonic examples.

4.2.4.5 Condition Register Logical Instructions

Condition register logical instructions, shown in Table 4-22, and the Move Condition Register Field (**mcrf**) instruction are also defined as flow control instructions.

Note that if the LR update option is enabled for any of these instructions, the PowerPC architecture defines these forms of the instructions as invalid.

Table 4-22. Condition Register Logical Instructions

Name	Mnemonic	Operand Syntax	Operation
Condition Register AND	crand	crbD,crbA,crbB	The CR bit specified by crbA is ANDed with the CR bit specified by crbB . The result is placed into the CR bit specified by crbD .
Condition Register OR	cror	crbD,crbA,crbB	The CR bit specified by crbA is ORed with the CR bit specified by crbB . The result is placed into the CR bit specified by crbD .
Condition Register XOR	crxor	crbD,crbA,crbB	The CR bit specified by crbA is XORed with the CR bit specified by crbB . The result is placed into the CR bit specified by crbD .
Condition Register NAND	crnand	crbD,crbA,crbB	The CR bit specified by crbA is ANDed with the CR bit specified by crbB . The complemented result is placed into the CR bit specified by crbD .
Condition Register NOR	crnor	crbD,crbA,crbB	The CR bit specified by crbA is ORed with the CR bit specified by crbB . The complemented result is placed into the CR bit specified by crbD .
Condition Register Equivalent	creqv	crbD,crbA, crbB	The CR bit specified by crbA is XORed with the CR bit specified by crbB . The complemented result is placed into the CR bit specified by crbD .
Condition Register AND with Complement	crandc	crbD,crbA, crbB	The CR bit specified by crbA is ANDed with the complement of the CR bit specified by crbB and the result is placed into the CR bit specified by crbD .
Condition Register OR with Complement	crorc	crbD,crbA, crbB	The CR bit specified by crbA is ORed with the complement of the CR bit specified by crbB and the result is placed into the CR bit specified by crbD .
Move Condition Register Field	mcrf	crfD,crfS	The contents of crfS are copied into crfD . No other condition register fields are changed.

4.2.4.6 Trap Instructions

The trap instructions shown in Table 4-23 are provided to test for a specified set of conditions. If any of the conditions tested by a trap instruction are met, the system trap handler is invoked. If the tested conditions are not met, instruction execution continues normally. See Appendix F, “Simplified Mnemonics,” for a complete set of simplified mnemonics.

Table 4-23. Trap Instructions

Name	Mnemonic	Operand Syntax	Operand Syntax
Trap Double Word Immediate (64-bit only)	tdi	TO,rA,SIMM	The contents of rA are compared with the sign-extended SIMM operand. If any bit in the TO operand is set and its corresponding condition is met by the result of the comparison, the system trap handler is invoked.
Trap Word Immediate	twi	TO,rA,SIMM	The contents of the low-order 32 bits of rA are compared with the sign-extended SIMM operand. If any bit in the TO operand is set and its corresponding condition is met by the result of the comparison, the system trap handler is invoked.
Trap Double Word (64-bit only)	td	TO,rA,rB	The contents of rA are compared with the contents of rB. If any bit in the TO operand is set and its corresponding condition is met by the result of the comparison, the system trap handler is invoked.
Trap Word	tw	TO,rA,rB	The contents of the low-order 32 bits of rA are compared with the contents of the low-order 32 bits of rB. If any bit in the TO operand is set and its corresponding condition is met by the result of the comparison, the system trap handler is invoked.

4.2.4.7 System Linkage Instruction—UISA

Table 4-24 describes the System Call (**sc**) instruction that permits a program to call on the system to perform a service. See Section 4.4.1, “System Linkage Instructions—OEA,” for a complete description of the **sc** instruction.

Table 4-24. System Linkage Instruction—UISA

Name	Mnemonic	Operand Syntax	Operation
System Call	sc	—	This instruction calls the operating system to perform a service. When control is returned to the program that executed the system call, the content of the registers will depend on the register conventions used by the program providing the system service. This instruction is context synchronizing as described in Section 4.1.5.1, “Context Synchronizing Instructions.” See Section 4.4.1, “System Linkage Instructions—OEA,” for a complete description of the sc instruction.

4.2.5 Processor Control Instructions—UISA

- U Processor control instructions are used to read from and write to the condition register (CR), machine state register (MSR), and special-purpose registers (SPRs). See
- V Section 4.3.1, “Processor Control Instructions—VEA,” for the **mftb** instruction and
- O Section 4.4.2, “Processor Control Instructions—OEA,” for information about the instructions used for reading from and writing to the MSR and SPRs.

4.2.5.1 Move to/from Condition Register Instructions

- U Table 4-25 summarizes the instructions for reading from or writing to the condition register.

Table 4-25. Move to/from Condition Register Instructions

Name	Mnemonic	Operand Syntax	Operation
Move to Condition Register Fields	mtcrf	CRM,rS	The contents of the low-order 32 bits of rS are placed into the CR under control of the field mask specified by operand CRM. The field mask identifies the 4-bit fields affected. Let i be an integer in the range 0–7. If $CRM(i) = 1$, CR field i (CR bits $4 * i$ through $4 * i + 3$) is set to the contents of the corresponding field of the low-order 32 bits of rS.
Move to Condition Register from XER	mcrxr	crfD	The contents of XER[0–3] are copied into the condition register field designated by crfD . All other CR fields remain unchanged. The contents of XER[0–3] are cleared.
Move from Condition Register	mfcrr	rD	The contents of the CR are placed into the low-order 32 bits of rD. The contents of the high-order 32 bits of rD are cleared in 64-bit implementations.

4.2.5.2 Move to/from Special-Purpose Register Instructions (UISA)

Table 4-26 provides a brief description of the **mtspr** and **mfspr** instructions. For more detailed information refer to Chapter 8, “Instruction Set.”

Table 4-26. Move to/from Special-Purpose Register Instructions (UISA)

Name	Mnemonic	Operand Syntax	Operation
Move to Special-Purpose Register	mtspr	SPR,rS	The value specified by rS are placed in the specified SPR. For 32-bit SPRs, the low-order 32 bits of rS are placed into the SPR.
Move from Special-Purpose Register	mfspr	rD,SPR	The contents of the specified SPR are placed in rD. For 32-bit SPRs, the low-order 32 bits of rD receive the contents of the SPR. The high-order 32 bits of rD are cleared.

4.2.6 Memory Synchronization Instructions—UISA

Memory synchronization instructions control the order in which memory operations are completed with respect to asynchronous events, and the order in which memory operations are seen by other processors or memory access mechanisms.

The number of cycles required to complete a **sync** instruction depends on system parameters and on the processor's state when the instruction is issued. As a result, frequent use of this instruction may degrade performance slightly. The **eiio** instruction may be more appropriate than **sync** for many cases.

The PowerPC architecture defines the **sync** instruction with CR update enabled (Rc field, bit 31 = 1) to be an invalid form.

The proper paired use of the **lwarx** with **stwcx.** and **ldarx** with **stdcx.** instructions allows programmers to emulate common semaphore operations such as test and set, compare and swap, exchange memory, and fetch and add. Examples of these semaphore operations can be found in Appendix E, “Synchronization Programming Examples.” The **lwarx** instruction must be paired with an **stwcx.** instruction, and **ldarx** instruction with an **stdcx.** instruction, with the same effective address specified by both instructions of the pair. The only exception is that an unpaired **stwcx.** or **stdcx.** instruction to any (scratch) effective address can be used to clear any reservation held by the processor. Note that the reservation granularity is implementation-dependent.

The concept behind the use of the **lwarx**, **ldarx**, **stwcx.**, and **stdcx.** instructions is that a processor may load a semaphore from memory, compute a result based on the value of the semaphore, and conditionally store it back to the same location. The conditional store is performed based upon the existence of a reservation established by the preceding **lwarx** or **ldarx** instruction. If the reservation exists when the store is executed, the store is performed and a bit is set in the CR. If the reservation does not exist when the store is executed, the target memory location is not modified and a bit is cleared in the CR.

The **lwarx**, **ldarx**, **stwcx.**, and **stdcx.** primitives allow software to read a semaphore, compute a result based on the value of the semaphore, store the new value back into the semaphore location only if that location has not been modified since it was first read, and determine if the store was successful. If the store was successful, the sequence of instructions from the read of the semaphore to the store that updated the semaphore appear to have been executed atomically (that is, no other processor or mechanism modified the semaphore location between the read and the update), thus providing the equivalent of a real atomic operation. However, in reality, other processors may have read from the location during this operation.

The **lwarx**, **ldarx**, **stwcx.**, and **stdcx.** instructions require the EA to be aligned.

In general, the **lwarx**, **ldarx**, **stwcx.**, and **stdcx.** instructions should be used only in system programs, which can be invoked by application programs as needed.

At most one reservation exists simultaneously on any processor. The address associated with the reservation can be changed by a subsequent **lwarx** or **ldarx** instruction. The conditional store is performed based upon the existence of a reservation established by the preceding **lwarx** or **ldarx** instruction.

A reservation held by the processor is cleared (or may be cleared, in the case of the fourth and fifth bullet items) by one of the following:

- The processor holding the reservation executes another **lwarx** or **ldarx** instruction; this clears the first reservation and establishes a new one.
- The processor holding the reservation executes any **stwcx.** or **stdcx.** instruction whether its address matches that of the **lwarx.**
- Some other processor executes a store or **dcbz** to the same reservation granule, or modifies a referenced or changed bit in the same reservation granule.
- Some other processor executes a **dcbtst,** **dcbst,** **dcbf,** or **dcbi** to the same reservation granule; whether the reservation is cleared is undefined.
- Some other processor executes a **dcbz** to the same reservation granule. The reservation is cleared if the instruction causes the target block to be newly established in the data cache or to be modified; otherwise, whether the reservation is cleared is undefined.
- Some other mechanism modifies a memory location in the same reservation granule.

Note that exceptions do not clear reservations; however, system software invoked by exceptions may clear reservations.

U Table 4-27 summarizes the memory synchronization instructions as defined in the UISA. See Section 4.3.2, “Memory Synchronization Instructions—VEA,” for details about additional memory synchronization (**eieio** and **isync**) instructions.

Table 4-27. Memory Synchronization Instructions—UISA

Name	Mnemonic	Operand Syntax	Operation
Load Double Word and Reserve Indexed (64-bit only)	ldarx	rD,rA,rB	The EA is the sum (rA 0) + (rB). The double word in memory addressed by the EA is loaded into rD.
Load Word and Reserve Indexed	lwarx	rD,rA,rB	The EA is the sum (rA 0) + (rB). The word in memory addressed by the EA is loaded into the low-order 32 bits of rD. The contents of the high-order 32 bits of rD are cleared for 64-bit implementations.

Table 4-27. Memory Synchronization Instructions—UIA (Continued)

Name	Mnemonic	Operand Syntax	Operation
Store Double Word Conditional Indexed (64-bit only)	stdcx.	rS,rA,rB	<p>The EA is the sum (rA 0) + (rB).</p> <p>If a reservation exists and the effective address specified by the stdcx. instruction is the same as that specified by the load and reserve instruction that established the reservation, the contents of rS are stored into the double word in memory addressed by the EA, and the reservation is cleared.</p> <p>If a reservation exists but the effective address specified by the stdcx. instruction is not the same as that specified by the load and reserve instruction that established the reservation, the reservation is cleared, and it is undefined whether the contents of rS are stored into the double word in memory addressed by the EA.</p> <p>If a reservation does not exist, the instruction completes without altering memory or the contents of the cache.</p>
Store Word Conditional Indexed	stwcx.	rS,rA,rB	<p>The EA is the sum (rA 0) + (rB).</p> <p>If a reservation exists and the effective address specified by the stwcx. instruction is the same as that specified by the load and reserve instruction that established the reservation, the low-order 32 bits of rS are stored into the word in memory addressed by the EA, and the reservation is cleared.</p> <p>If a reservation exists but the effective address specified by the stwcx. instruction is not the same as that specified by the load and reserve instruction that established the reservation, the reservation is cleared, and it is undefined whether the low-order 32 bits of rS are stored into the word in memory addressed by the EA.</p> <p>If a reservation does not exist, the instruction completes without altering memory or the contents of the cache.</p>
Synchronize	sync	—	<p>Executing a sync instruction ensures that all instructions preceding the sync instruction appear to have completed before the sync instruction completes, and that no subsequent instructions are initiated by the processor until after the sync instruction completes. When the sync instruction completes, all memory accesses caused by instructions preceding the sync instruction will have been performed with respect to all other mechanisms that access memory.</p> <p>See Chapter 8, "Instruction Set," for more information.</p>

4.2.7 Recommended Simplified Mnemonics

To simplify assembly language programs, a set of simplified mnemonics is provided for some of the most frequently used operations (such as no-op, load immediate, load address, move register, and complement register). Assemblers should provide the simplified mnemonics listed in Section F.9, "Recommended Simplified Mnemonics." Programs written to be portable across the various assemblers for the PowerPC architecture should not assume the existence of mnemonics not described in this document.

For a complete list of simplified mnemonics, see Appendix F, "Simplified Mnemonics."

4.3 PowerPC VEA Instructions

- U The PowerPC virtual environment architecture (VEA) describes the semantics of the
- V memory model that can be assumed by software processes, and includes descriptions of the
- O cache model, cache-control instructions, address aliasing, and other related issues. Implementations that conform to the VEA also adhere to the UISA, but may not necessarily adhere to the OEA.

This section describes additional instructions that are provided by the VEA.

4.3.1 Processor Control Instructions—VEA

- V The VEA defines the **mftb** instruction (user-level instruction) for reading the contents of the time base register; see Chapter 5, “Cache Model and Memory Coherency,” for more information. Table 4-28 describes the **mftb** instruction.

Simplified mnemonics are provided (See Section F.8, “Simplified Mnemonics for Special-Purpose Registers”) for the **mftb** instruction so it can be coded with the TBR name as part of the mnemonic rather than requiring it to be coded as an operand. The simplified mnemonics Move from Time Base (**mftb**) and Move from Time Base Upper (**mftbu**) are variants of the **mftb** instruction rather than of the **mfspr** instruction. The **mftb** instruction serves as both a basic and simplified mnemonic. Assemblers recognize an **mftb** mnemonic with two operands as the basic form, and an **mftb** mnemonic with one operand as the simplified form.

On 32-bit implementations, it is not possible to read the entire 64-bit time base register in a single instruction. The **mftb** simplified mnemonic moves from the lower half of the time base register (TBL) to a GPR, and the **mftbu** simplified mnemonic moves from the upper half of the time base (TBU) to a GPR.

Table 4-28. Move from Time Base Instruction

Name	Mnemonic	Operand Syntax	Operation
Move from Time Base	mftb	rD, TBR	The TBR field denotes either time base lower or time base upper, encoded as shown in Table 4-29 and Table 4-30. The contents of the designated register are copied to rD. When reading TBU on a 64-bit implementation, the high-order 32 bits of rD are cleared. When reading TBL on a 64-bit implementation, the 64 bits of the time base are copied to rD.

Table 4-29 summarizes the time base (TBL/TBU) register encodings to which user-level access (using **mftb**) is permitted (as specified by the VEA).

Table 4-29. User-Level TBR Encodings (VEA)

Decimal Value in TBR Field	tbr[0–4] tbr[5–9]	Register Name	Description
268	01100 01000	TBL	Time base lower (read-only)
269	01101 01000	TBU	Time base upper (read-only)

Table 4-30 summarizes the TBL and TBU register encodings to which supervisor-level access (using **mtspr**) is permitted.

Table 4-30. Supervisor-Level TBR Encodings (VEA)

Decimal Value in SPR Field	spr[0–4] spr[5–9]	Register Name	Description
284	11100 01000	TBL ¹	Time base lower (write only)
285	11101 01000	TBU ¹	Time base upper (write only)

¹Moving from the time base (TBL and TBU) can also be accomplished with the **mftb** instruction.

4.3.2 Memory Synchronization Instructions—VEA

Memory synchronization instructions control the order in which memory operations are completed with respect to asynchronous events, and the order in which memory operations are seen by other processors or memory access mechanisms. See Chapter 5, “Cache Model and Memory Coherency,” for additional information about these instructions and about related aspects of memory synchronization.

System designs that use a second-level cache should take special care to recognize the hardware signaling caused by a **sync** operation and perform the appropriate actions to guarantee that memory references that may be queued internally to the second-level cache have been performed globally.

In addition to the **sync** instruction (specified by UISA), the VEA defines the Enforce In-Order Execution of I/O (**eiio**) and Instruction Synchronize (**isync**) instructions; see Table 4-31. The number of cycles required to complete an **eiio** instruction depends on system parameters and on the processor's state when the instruction is issued. As a result, frequent use of this instruction may degrade performance slightly.

The **isync** instruction causes the processor to wait for any preceding instructions to complete, discard all prefetched instructions, and then branch to the next sequential instruction (which has the effect of clearing the pipeline behind the **isync** instruction).

Table 4-31. Memory Synchronization Instructions—VEA

Name	Mnemonic	Operand Syntax	Operation
Enforce In-Order Execution of I/O	eieio	—	The eieio instruction provides an ordering function for the effects of loads and stores executed by a processor.
Instruction Synchronize	isync	—	Executing an isync instruction ensures that all previous instructions complete before the isync instruction completes, although memory accesses caused by those instructions need not have been performed with respect to other processors and mechanisms. It also ensures that the processor initiates no subsequent instructions until the isync instruction completes. Finally, it causes the processor to discard any prefetched instructions, so subsequent instructions will be fetched and executed in the context established by the instructions preceding the isync instruction. This instruction does not affect other processors or their caches.

4.3.3 Memory Control Instructions—VEA

- ∇ Memory control instructions include the following types:
 - • Cache management instructions (user-level and supervisor-level)
 - Segment register manipulation instructions
 - Segment lookaside buffer management instructions
 - Translation lookaside buffer management instructions

This section describes the user-level cache management instructions defined by the VEA. See Section 4.4.3, “Memory Control Instructions—OEA,” for more information about supervisor-level cache, segment register manipulation, and translation lookaside buffer management instructions.

4.3.3.1 User-Level Cache Instructions—VEA

- ∇ The instructions summarized in this section provide user-level programs the ability to manage on-chip caches if they are implemented. See Chapter 5, “Cache Model and Memory Coherency,” for more information about cache topics.

As with other memory-related instructions, the effect of the cache management instructions on memory are weakly ordered. If the programmer needs to ensure that cache or other instructions have been performed with respect to all other processors and system mechanisms, a **sync** instruction must be placed in the program following those instructions.

- Note that when data address translation is disabled ($MSR[DR] = 0$), the Data Cache Block Clear to Zero (**dcbz**) and the Data Cache Block Allocate (**dcba**) instructions allocate a cache block in the cache and may not verify that the physical address (referred to as real address in the architecture specification) is valid. If a cache block is created for an invalid physical address, a machine check condition may result when an attempt is made to write that cache block back to memory. The cache block could be written back as a result of the

execution of an instruction that causes a cache miss and the invalid addressed cache block is the target for replacement or a Data Cache Block Store (**dcbst**) instruction.

Any cache control instruction that generates an effective address that corresponds to a direct-store segment (segment descriptor[T] = 1) is treated as a no-op. However, note that the direct-store facility is being phased out of the architecture and will not likely be supported in future devices.

Table 4-32 summarizes the cache instructions defined by the VEA. Note that these instructions are accessible to user-level programs.

Table 4-32. User-Level Cache Instructions

Name	Mnemonic	Operand Syntax	Operation
Data Cache Block Touch	dcbt	rA,rB	The EA is the sum (rA 0) + (rB). This instruction is a hint that performance will probably be improved if the block containing the byte addressed by EA is fetched into the data cache, because the program will probably soon load from the addressed byte.
Data Cache Block Touch for Store	dcbstst	rA,rB	The EA is the sum (rA 0) + (rB). This instruction is a hint that performance will probably be improved if the block containing the byte addressed by EA is fetched into the data cache, because the program will probably soon store into the addressed byte.
Data Cache Block Allocate	dcba	rA,rB	The EA is the sum (rA 0) + (rB). If the cache block containing the byte addressed by the EA is in the data cache, all bytes of the cache block are made undefined, but the cache block is still considered valid. Note that programming errors can occur if the data in this cache block is subsequently read or used inadvertently. If the page containing the byte addressed by the EA is not in the data cache and the corresponding page is marked caching allowed (I = 0), the cache block is allocated (and made valid) in the data cache without fetching the block from main memory, and the value of all bytes of the cache block is undefined. If the page containing the byte addressed by the EA is marked caching inhibited (WIM = x1x), this instruction is treated as a no-op. If the cache block addressed by the EA is located in a page marked as memory coherent (WIM = xx1) and the cache block exists in the caches of other processors, memory coherence is maintained in those caches. The dcba instruction is treated as a store to the addressed byte with respect to address translation, memory protection, referenced and changed recording, and the ordering enforced by ei or by the combination of caching-inhibited and guarded attributes for a page. This instruction is optional in the PowerPC architecture. (In the PowerPC OEA, the dcba instruction is additionally defined to clear all bytes of a newly established block to zero in the case that the block did not already exist in the cache.)

Table 4-32. User-Level Cache Instructions (Continued)

Name	Mnemonic	Operand Syntax	Operation
Data Cache Block Clear to Zero	dcbz	rA,rB	<p>The EA is the sum (rA 0) + (rB).</p> <p>If the cache block containing the byte addressed by the EA is in the data cache, all bytes of the cache block are cleared to zero.</p> <p>If the page containing the byte addressed by the EA is not in the data cache and the corresponding page is marked caching allowed (I = 0), the cache block is established in the data cache without fetching the block from main memory, and all bytes of the cache block are cleared to zero.</p> <p>If the page containing the byte addressed by the EA is marked caching inhibited (WIM = x1x) or write-through (WIM = 1xx), either all bytes of the area of main memory that corresponds to the addressed cache block are cleared to zero, or an alignment exception occurs.</p> <p>If the cache block addressed by the EA is located in a page marked as memory coherent (WIM = xx1) and the cache block exists in the caches of other processors, memory coherence is maintained in those caches.</p> <p>The dcbz instruction is treated as a store to the addressed byte with respect to address translation, memory protection, referenced and changed recording, and the ordering enforced by ei or by the combination of caching-inhibited and guarded attributes for a page.</p>
Data Cache Block Store	dcbst	rA,rB	<p>The EA is the sum(rA 0) + (rB).</p> <p>If the cache block containing the byte addressed by the EA is located in a page marked memory coherent (WIM = xx1), and a cache block containing the byte addressed by EA is in the data cache of any processor and has been modified, the cache block is written to main memory.</p> <p>If the cache block containing the byte addressed by the EA is located in a page not marked memory coherent (WIM = xx0), and a cache block containing the byte addressed by EA is in the data cache of this processor and has been modified, the cache block is written to main memory.</p> <p>The function of this instruction is independent of the write-through/write-back and caching-inhibited/caching-allowed modes of the cache block containing the byte addressed by the EA.</p> <p>The dcbst instruction is treated as a load from the addressed byte with respect to address translation and memory protection. It may also be treated as a load for referenced and changed bit recording except that referenced and changed bit recording may not occur.</p>

Table 4-32. User-Level Cache Instructions (Continued)

Name	Mnemonic	Operand Syntax	Operation
Data Cache Block Flush	dcbf	rA,rB	<p>The EA is the sum (rA 0) + (rB).</p> <p>The action taken depends on the memory mode associated with the target, and on the state of the block. The following list describes the action taken for the various cases, regardless of whether the page or block containing the addressed byte is designated as write-through or if it is in the caching-inhibited or caching-allowed mode.</p> <ul style="list-style-type: none"> • Coherency required (WIM = xx1) <ul style="list-style-type: none"> — Unmodified block—Invalidates copies of the block in the caches of all processors. — Modified block—Copies the block to memory. Invalidates copies of the block in the caches of all processors. — Absent block—If modified copies of the block are in the caches of other processors, causes them to be copied to memory and invalidated. If unmodified copies are in the caches of other processors, causes those copies to be invalidated. • Coherency not required (WIM = xx0) <ul style="list-style-type: none"> — Unmodified block—Invalidates the block in the processor's cache. — Modified block—Copies the block to memory. Invalidates the block in the processor's cache. — Absent block—Does nothing. <p>The function of this instruction is independent of the write-through/write-back and caching-inhibited/caching-allowed modes of the cache block containing the byte addressed by the EA.</p> <p>The dcbf instruction is treated as a load from the addressed byte with respect to address translation and memory protection. It may also be treated as a load for referenced and changed bit recording except that referenced and changed bit recording may not occur.</p>
Instruction Cache Block Invalidate	icbi	rA,rB	<p>The EA is the sum (rA 0) + (rB).</p> <p>If the cache block containing the byte addressed by EA is located in a page marked memory coherent (WIM = xx1), and a cache block containing the byte addressed by EA is in the instruction cache of any processor, the cache block is made invalid in all such instruction caches, so that the next reference causes the cache block to be refetched.</p> <p>If the cache block containing the byte addressed by EA is located in a page not marked memory coherent (WIM = xx0), and a cache block containing the byte addressed by EA is in the instruction cache of this processor, the cache block is made invalid in that instruction cache, so that the next reference causes the cache block to be refetched.</p> <p>The function of this instruction is independent of the write-through/write-back and caching-inhibited/caching-allowed modes of the cache block containing the byte addressed by the EA.</p> <p>The icbi instruction is treated as a load from the addressed byte with respect to address translation and memory protection. It may also be treated as a load for referenced and changed bit recording except that referenced and changed bit recording may not occur.</p>

4.3.4 External Control Instructions

The external control instructions allow a user-level program to communicate with a special-purpose device. Two instructions are provided and are summarized in Table 4-33.

Table 4-33. External Control Instructions

Name	Mnemonic	Operand Syntax	Operation
External Control In Word Indexed	eciwx	rD,rA,rB	<p>The EA is the sum $(rA 0) + (rB)$.</p> <p>A load word request for the physical address corresponding to the EA is sent to the device identified by the EAR[RID] (bits 26–31), bypassing the cache. The word returned by the device is placed into the low-order 32 bits of rD. The value in the high-order 32 bits of rD is cleared to zero in 64-bit implementations. The EA sent to the device must be word-aligned.</p> <p>This instruction is treated as a load from the addressed byte with respect to address translation, memory protection, referenced and changed recording, and the ordering performed by eieio.</p> <p>This instruction is optional.</p>
External Control Out Word Indexed	ecowx	rS,rA,rB	<p>The EA is the sum $(rA 0) + (rB)$.</p> <p>A store word request for the physical address corresponding to the EA and the contents of the low-order 32 bits of rS are sent to the device identified by EAR[RID] (bits 26–31), bypassing the cache. The EA sent to the device must be word-aligned.</p> <p>This instruction is treated as a store to the addressed byte with respect to address translation, memory protection, referenced and changed recording, and the ordering performed by eieio. Software synchronization is required in order to ensure that the data access is performed in program order with respect to data accesses caused by other store or ecowx instructions, even though the addressed byte is assumed to be caching-inhibited and guarded.</p> <p>This instruction is optional.</p>

4.4 PowerPC OEA Instructions

The PowerPC operating environment architecture (OEA) includes the structure of the memory management model, supervisor-level registers, and the exception model. Implementations that conform to the OEA also adhere to the UISA and the VEA. This section describes the instructions provided by the OEA.

4.4.1 System Linkage Instructions—OEA

This section describes the system linkage instructions (see Table 4-34). The **sc** instruction is a user-level instruction that permits a user program to call on the system to perform a service and causes the processor to take an exception. The **rfi** and **rfid** instructions are supervisor-level instructions that are useful for returning from an exception handler.

Table 4-34. System Linkage Instructions—OEA

Name	Mnemonic	Operand Syntax	Operation
System Call	sc	—	<p>When executed, the effective address of the instruction following the sc instruction is placed into SRR0. Bits 33–36 and 42–47 (bits 1–4, and 10–15 for 32-bit implementations) of SRR1 are cleared. Additionally, bits 48–55, 57–59, and 62–63 (16–23, 25–27, and 30–31 for 32-bit implementations) of the MSR are placed into the corresponding bits of SRR1. Depending on the implementation, additional bits of MSR may also be saved in SRR1. Then a system call exception is generated. The exception causes the MSR to be altered as described in Section 6.4, “Exception Definitions.”</p> <p>The exception causes the next instruction to be fetched from offset 0xC00 from the base physical address indicated by the new setting of MSR[IP].</p> <p>This instruction is context synchronizing.</p>
Return from Interrupt (32-bit only)	rfi	—	<p>Bits 16–23, 25–27, and 30–31 of SRR1 are placed into the corresponding bits of the MSR. Depending on the implementation, additional bits of MSR may also be restored from SRR1. If the new MSR value does not enable any pending exceptions, the next instruction is fetched, under control of the new MSR value, from the address SRR0[0–29] 0b00.</p> <p>If the new MSR value enables one or more pending exceptions, the exception associated with the highest priority pending exception is generated; in this case the value placed into SRR0 (machine status save/restore 0) by the exception processing mechanism is the address of the instruction that would have been executed next had the exception not occurred.</p> <p>This is a supervisor-level instruction and is context-synchronizing.</p> <p>This instruction is defined only for 32-bit implementations. The use of the rfi instruction on a 64-bit implementation will invoke the system exception handler.</p>

Table 4-34. System Linkage Instructions—OEA (Continued)

Name	Mnemonic	Operand Syntax	Operation
<p>64-BIT BRIDGE Return from Interrupt</p>	<p>rfi</p>	<p>—</p>	<p>Bits 0, 48–55, 57–59, and 62–63 of SRR1 are placed into the corresponding bits of the MSR. Depending on the implementation, additional bits of MSR may also be restored from SRR1. If the new MSR value does not enable any pending exceptions, the next instruction is fetched, under control of the new MSR value, from the address SRR0 [0–61] 0b00 (when SF = 1 in the new MSR value) or 0x0000_0000 SRR0[32–61] 0b00 (when SF = 0 in the new MSR value).</p> <p>If the new MSR value enables one or more pending exceptions, the exception associated with the highest priority pending exception is generated; in this case, the value placed into SRR0 (machine status save/restore 0) by the exception processing mechanism is the address of the instruction that would have been executed next had the exception not occurred.</p> <p>This is a supervisor-level instruction and is context-synchronizing.</p>
<p>Return from Interrupt Double Word (64-bit only)</p>	<p>rfid</p>	<p>—</p>	<p>Bits 0, 48–55, 57–59, and 62–63 of SRR1 are placed into the corresponding bits of the MSR. Depending on the implementation, additional bits of MSR may also be restored from SRR1. If the new MSR value does not enable any pending exceptions, the next instruction is fetched, under control of the new MSR value, from the address SRR0[0–61] 0b00 (default 64-bit mode) or (32)0 the low-order 32 bits of SRR0 0b00 (32-bit mode of 64-bit implementations).</p> <p>If the new MSR value enables one or more pending exceptions, the exception associated with the highest priority pending exception is generated; in this case, the value placed into SRR0 (machine status save/restore 0) by the exception processing mechanism is the address of the instruction that would have been executed next had the exception not occurred.</p> <p>This is a supervisor-level instruction and is context-synchronizing.</p> <p>This instruction is defined only for 64-bit implementations. The use of the rfid instruction on a 32-bit implementation will invoke the system exception handler.</p>

4.4.2 Processor Control Instructions—OEA

This section describes the processor control instructions that are used to read from and write to the MSR and the SPRs.

4.4.2.1 Move to/from Machine State Register Instructions

Table 4-35 summarizes the instructions used for reading from and writing to the MSR.

Table 4-35. Move to/from Machine State Register Instructions

Name	Mnemonic	Operand Syntax	Operation
Move to Machine State Register (32-bit only)	mtmsr	rS	The contents of rS are placed into the MSR. This instruction is a supervisor-level instruction and is context synchronizing except with respect to alterations to the POW and LE bits. Refer to Section 2.3.18, “Synchronization Requirements for Special Registers and for Lookaside Buffers,” for more information.
64-BIT BRIDGE Move to Machine State Register	mtmsr	rS	Bits 32–63 of rS are placed into the MSR. Bits 0–31 of the MSR remain unchanged. This instruction is a supervisor-level instruction and is context synchronizing except with respect to alterations to the POW and LE bits. Refer to Section 2.3.18, “Synchronization Requirements for Special Registers and for Lookaside Buffers,” for more information.
Move to Machine State Register Double Word (64-bit only)	mtmsrd	rS	The contents of rS are placed into the MSR. This instruction is a supervisor-level instruction and is context synchronizing except with respect to alterations to the POW and LE bits. Refer to Section 2.3.18, “Synchronization Requirements for Special Registers and for Lookaside Buffers,” for more information.
Move from Machine State Register	mfmsr	rD	The contents of the MSR are placed into rD. This is a supervisor-level instruction.

4.4.2.2 Move to/from Special-Purpose Register Instructions (OEA)

Provided is a brief description of the **mtspr** and **mfspir** instructions (see Table 4-36). For more detailed information, see Chapter 8, “Instruction Set.” Simplified mnemonics are provided for the **mtspr** and **mfspir** instructions in Appendix F, “Simplified Mnemonics.” For a discussion of context synchronization requirements when altering certain SPRs, refer to Appendix E, “Synchronization Programming Examples.”

Table 4-36. Move to/from Special-Purpose Register Instructions (OEA)

Name	Mnemonic	Operand Syntax	Operation
Move to Special-Purpose Register	mtspr	SPR,rS	The SPR field denotes a special-purpose register. The contents of rS are placed into the designated SPR. For SPRs that are 32 bits long, the contents of the low-order 32 bits of rS are placed into the SPR. For this instruction, SPRs TBL and TBU are treated as separate 32-bit registers; setting one leaves the other unaltered.
Move from Special-Purpose Register	mfspir	rD,SPR	The SPR field denotes a special-purpose register. The contents of the designated SPR are placed into rD.

For **mtspr** and **mfspr** instructions, the SPR number coded in assembly language does not appear directly as a 10-bit binary number in the instruction. The number coded is split into two 5-bit halves that are reversed in the instruction encoding, with the high-order 5 bits appearing in bits 16–20 of the instruction encoding and the low-order 5 bits in bits 11–15.

For information on SPR encodings (both user- and supervisor-level), see Chapter 8, “Instruction Set.” Note that there are additional SPRs specific to each implementation; for implementation-specific SPRs, see the user’s manual for that particular processor.

4.4.3 Memory Control Instructions—OEA

Memory control instructions include the following types of instructions:

- Cache management instructions (supervisor-level and user-level)
- Segment register manipulation instructions
- Translation lookaside buffer management instructions

This section describes supervisor-level memory control instructions. See Section 4.3.3, “Memory Control Instructions—VEA,” for more information about user-level cache management instructions.

4.4.3.1 Supervisor-Level Cache Management Instruction

Table 4-37 summarizes the operation of the only supervisor-level cache management instruction. See Section 4.3.3.1, “User-Level Cache Instructions—VEA,” for cache instructions that provide user-level programs the ability to manage the on-chip caches.

Note that any cache control instruction that generates an effective address that corresponds to a direct-store segment (segment descriptor[T] = 1) is treated as a no-op. However, note that the direct-store facility is being phased out of the architecture and will not likely be supported in future devices.

Table 4-37. Cache Management Supervisor-Level Instruction

Name	Mnemonic	Operand Syntax	Operation
Data Cache Block Invalidate	dcbi	rA,rB	<p>The EA is the sum $(rA 0) + (rB)$.</p> <p>The action taken depends on the memory mode associated with the target, and the state (modified, unmodified) of the cache block. The following list describes the action to take if the cache block containing the byte addressed by the EA is or is not in the cache.</p> <ul style="list-style-type: none"> • Coherency required (WIM = xx1) <ul style="list-style-type: none"> — Unmodified cache block—Invalidates copies of the cache block in the caches of all processors. — Modified cache block—Invalidates copies of the cache block in the caches of all processors. (Discards the modified contents.) — Absent cache block—If copies are in the caches of any other processor, causes the copies to be invalidated. (Discards any modified contents.) • Coherency not required (WIM = xx0) <ul style="list-style-type: none"> — Unmodified cache block—Invalidates the cache block in the local cache. — Modified cache block—Invalidates the cache block in the local cache. (Discards the modified contents.) — Absent cache block—No action is taken. <p>When data address translation is enabled, MSR[DT]=1, and the logical (effective) address has no translation, a data access exception occurs.</p> <p>The function of this instruction is independent of the write-through and cache-inhibited/allowed modes determined by the WIM bit settings of the block containing the byte addressed by the EA.</p> <p>This instruction is treated as a store to the addressed byte with respect to address translation and protection, except that the change bit need not be set, and if the change bit is not set then the reference bit need not be set.</p>

4.4.3.2 Segment Register Manipulation Instructions

The instructions listed in Table 4-38 provide access to the segment registers for 32-bit implementations, and effective segments 0 through 15 through the use of the optional 64-bit bridge instructions. These instructions operate completely independently of the MSR[IR] and MSR[DR] bit settings. Refer to Section 2.3.18, “Synchronization Requirements for Special Registers and for Lookaside Buffers,” for serialization requirements and other recommended precautions to observe when manipulating the segment registers.

Table 4-38. Segment Register Manipulation Instructions

Name	Mnemonic	Operand Syntax	Operation
Move to Segment Register (32-bit only)	mtsr	SR,rS	The contents of rS are placed into segment register specified by operand SR. This is a supervisor-level instruction.
64-BIT BRIDGE Move to Segment Register	mtsr	SR,rS	The SLB entry selected by SR is set as though it were loaded from a segment table entry. Refer to Section 8.2, "PowerPC Instruction Set," for additional information about the operation of the 64-bit bridge mtsr instruction. This instruction is a supervisor-level instruction.
64-BIT BRIDGE Move to Segment Register Double Word	mtsrdd	SR,rS	The SLB entry selected by SR is set as though it were loaded from a segment table entry. Refer to Section 8.2, "PowerPC Instruction Set," for additional information about the operation of the 64-bit bridge mtsrdd instruction. This instruction is a supervisor-level instruction. This instruction is defined only for 64-bit implementations. The use of the mtsrdd instruction on a 32-bit implementation will invoke the system exception handler.
64-BIT BRIDGE Move to Segment Register Double Word Indirect	mtsrddin	rS,rB	The SLB entry selected by bits 32–35 of register rB is set as though it were loaded from a segment table entry. Refer to Section 8.2, "PowerPC Instruction Set," for additional information about the operation of the 64-bit bridge mtsrddin instruction. This instruction is a supervisor-level instruction. This instruction is defined only for 64-bit implementations. The use of the mtsrddin instruction on a 32-bit implementation will invoke the system exception handler.
Move to Segment Register Indirect (32-bit only)	mtsrin	rS,rB	The contents of rS are copied to the segment register selected by bits 0–3 of rB. This is a supervisor-level instruction.
64-BIT BRIDGE Move to Segment Register Indirect	mtsrin	rS,rB	The SLB entry selected by bits 32–35 of register rB is set as though it were loaded from a segment table entry. Refer to Section 8.2, "PowerPC Instruction Set," for additional information about the operation of the 64-bit bridge mtsrin instruction. This instruction is a supervisor-level instruction.
Move from Segment Register (32-bit only)	mfsr	rD,SR	The contents of the segment register specified by operand SR are placed into rD. This is a supervisor-level instruction.

Table 4-38. Segment Register Manipulation Instructions (Continued)

Name	Mnemonic	Operand Syntax	Operation
64-BIT BRIDGE Move from Segment Register	mfsr	rD,SR	The contents of the SLB entry specified by operand SR are placed into rD. Refer to Section 8.2, "PowerPC Instruction Set," for additional information about the operation of the 64-bit bridge mfsr instruction. This instruction is a supervisor-level instruction.
Move from Segment Register Indirect (32-bit only)	mfsrin	rD,rB	The contents of the segment register selected by bits 0–3 of rB are copied into rD. This is a supervisor-level instruction.
64-BIT BRIDGE Move from Segment Register Indirect	mfsrin	rD,rB	The contents of the SLB entry specified by bits 32–35 of rB are placed into rD. Refer to Section 8.2, "PowerPC Instruction Set," for additional information about the operation of the 64-bit bridge mfsrin instruction. This instruction is a supervisor-level instruction.

4.4.3.3 Translation and Segment Lookaside Buffer Management Instructions

The address translation mechanism is defined in terms of segment descriptors and page table entries (PTEs) used by PowerPC processors to locate the logical-to-physical address mapping for a particular access. These segment descriptors and PTEs reside in segment tables and page tables in memory, respectively.

For performance reasons, many processors implement a segment lookaside buffer (SLB) (for 64-bit implementations) and one or more translation lookaside buffers on-chip. These are caches of portions of the segment table and page table, respectively. As changes are made to the address translation tables, it is necessary to maintain coherency between the SLB and TLB and the updated tables. This is done by invalidating SLB and TLB entries, or occasionally by invalidating the entire SLB or TLB, and allowing the translation caching mechanism to refetch from the tables. Note that in 32-bit implementations, segment descriptors reside in 16 segment registers, and no other segment tables in memory (or SLBs) are defined.

Each PowerPC implementation that has an SLB provides means for invalidating an individual SLB entry and invalidating the entire SLB. Each PowerPC implementation that has a TLB provides means for invalidating an individual TLB entry and invalidating the entire TLB.

If a 64-bit implementation does not implement an SLB, it treats the corresponding instructions (**slbie** and **slbia**) either as no-ops or as illegal instructions. Similarly, if a processor does not implement a TLB, it treats the corresponding instructions (**tlbie**, **tlbia**, and **tlbsync**) either as no-ops or as illegal instructions.

Refer to Chapter 7, “Memory Management,” for more information about TLB operation. Table 4-39 summarizes the operation of the SLB and TLB instructions.

Table 4-39. Translation Lookaside Buffer Management Instructions

Name	Mnemonic	Operand Syntax	Operation
SLB Invalidate Entry (64-bit only)	slbie	rB	The EA is the contents of rB. If the SLB contains an entry corresponding to the EA, that entry is removed from the SLB. The SLB search is performed regardless of the settings of MSR[IR] and MSR[DR]. Block address translation for the EA, if any, is ignored. When slbie is issued, the ASR need not point to a valid segment table. This is a supervisor-level instruction and optional in the PowerPC architecture.
SLB Invalidate All (64-bit only)	slbia	—	All SLB entries are made invalid. The SLB is invalidated regardless of the settings of MSR[IR] and MSR[DR]. When slbia is issued, the ASR need not point to a valid segment table. This is a supervisor-level instruction and optional in the PowerPC architecture.
TLB Invalidate Entry	tlbie	rB	The EA is the contents of rB. If the TLB contains an entry corresponding to the EA, that entry is removed from the TLB. The TLB search is performed regardless of the settings of MSR[IR] and MSR[DR]. Block address translation for the EA, if any, is ignored. This instruction causes the target TLB entry to be invalidated in all processors. The operation performed by this instruction is treated as a caching inhibited and guarded data access with respect to the ordering performed by eieio . This is a supervisor-level instruction and optional in the PowerPC architecture.
TLB Invalidate All	tlbia	—	All TLB entries are made invalid. The TLB is invalidated regardless of the settings of MSR[IR] and MSR[DR]. This instruction does not cause the entries to be invalidated in other processors. This is a supervisor-level instruction and optional in the PowerPC architecture.
TLB Synchronize	tlbsync	—	Executing a tlbsync instruction ensures that all tlbie instructions previously executed by the processor executing the tlbsync instruction have completed on all processors. The operation performed by this instruction is treated as a caching inhibited and guarded data access with respect to the ordering performed by eieio . This is a supervisor-level instruction and optional in the PowerPC architecture.

Because the presence and exact semantics of the translation lookaside buffer management instructions is implementation-dependent, system software should incorporate uses of the instruction into subroutines to minimize compatibility problems.

Chapter 5

Cache Model and Memory Coherency

This chapter summarizes the cache model as defined by the virtual environment architecture (VEA) as well as the built-in architectural controls for maintaining memory coherency. This chapter describes the cache control instructions and special concerns for memory coherency in single-processor and multiprocessor systems. Aspects of the operating environment architecture (OEA) as they relate to the cache model and memory coherency are also covered.

The PowerPC architecture provides for relaxed memory coherency. Features such as write-back caching and out-of-order execution allow software engineers to exploit the performance benefits of weakly-ordered memory access. The architecture also provides the means to control the order of accesses for order-critical operations.

In this chapter, the term multiprocessor is used in the context of maintaining cache coherency. In this context, a system could include other devices that access system memory, maintain independent caches, and function as bus masters.

Each cache management instruction operates on an aligned unit of memory. The VEA defines this cacheable unit as a block. Since the term 'block' is easily confused with the unit of memory addressed by the block address translation (BAT) mechanism, this chapter uses the term 'cache block' to indicate the cacheable unit. The size of the cache block can vary by instruction and by implementation. In addition, the unit of memory at which coherency is maintained is called the coherence block. The size of the coherence block is also implementation-specific. However, the coherence block is often the same size as the cache block.

5.1 The Virtual Environment

The user instruction set architecture (UISA) relies upon a memory space of 2^{64} (2^{32} in 32-bit implementations) bytes for applications. The VEA expands upon the memory model by introducing virtual memory, caches, and shared memory multiprocessing. Although many applications will not need to access the features introduced by the VEA, it is important that programmers are aware that they are working in a virtual environment where the physical memory may be shared by multiple processes running on one or more processors.

This section describes load and store ordering, atomicity, the cache model, memory coherency, and the VEA cache management instructions. The features of the VEA are accessible to both user-level and supervisor-level applications (referred to as problem state and privileged state, respectively, in the architecture specification).

The mechanism for controlling the virtual memory space is defined by the OEA. The features of the OEA are accessible to supervisor-level applications only (typically operating systems). For more information on the address translation mechanism, refer to Chapter 7, “Memory Management.”

5.1.1 Memory Access Ordering

The VEA specifies a weakly consistent memory model for shared memory multiprocessor systems. This model provides an opportunity for significantly improved performance over a model that has stronger consistency rules, but places the responsibility for access ordering on the programmer. When a program requires strict access ordering for proper execution, the programmer must insert the appropriate ordering or synchronization instructions into the program.

The order in which the processor performs memory accesses, the order in which those accesses complete in memory, and the order in which those accesses are viewed as occurring by another processor may all be different. A means of enforcing memory access ordering is provided to allow programs (or instances of programs) to share memory. Similar means are needed to allow programs executing on a processor to share memory with some other mechanism, such as an I/O device, that can also access memory.

Various facilities are provided that enable programs to control the order in which memory accesses are performed by separate instructions. First, if separate store instructions access memory that is designated as both caching-inhibited and guarded, the accesses are performed in the order specified by the program. Refer to Section 5.1.4, “Memory Coherency,” and Section 5.2.1, “Memory/Cache Access Attributes,” for a complete description of the caching-inhibited and guarded attributes. Additionally, two instructions, **eiio** and **sync**, are provided that enable the program to control the order in which the memory accesses caused by separate instructions are performed.

No ordering should be assumed among the memory accesses caused by a single instruction (that is, by an instruction for which multiple accesses are not atomic), and no means are provided for controlling that order. Chapter 4, “Addressing Modes and Instruction Set Summary,” contains additional information about the **sync** and **eiio** instructions.

5.1.1.1 Enforce In-Order Execution of I/O Instruction

The **eiio** instruction permits the program to control the order in which loads and stores are performed when the accessed memory has certain attributes, as described in Chapter 8, “Instruction Set.” For example, **eiio** can be used to ensure that a sequence of load and store operations to an I/O device’s control registers updates those registers in the desired order.

The **eiio** instruction can also be used to ensure that all stores to a shared data structure are visible to other processors before the store that releases the lock is visible to them.

The **eiio** instruction may complete before memory accesses caused by instructions preceding the **eiio** instruction have been performed with respect to system memory or coherent storage as appropriate.

If stronger ordering is desired, the **sync** instruction must be used.

5.1.1.2 Synchronize Instruction

When a portion of memory that requires coherency must be forced to a known state, it is necessary to synchronize memory with respect to other processors and mechanisms. This synchronization is accomplished by requiring programs to indicate explicitly in the instruction stream, by inserting a **sync** instruction, that synchronization is required. Only when **sync** completes are the effects of all coherent memory accesses previously executed by the program guaranteed to have been performed with respect to all other processors and mechanisms that access those locations coherently.

The **sync** instruction ensures that all the coherent memory accesses, initiated by a program, have been performed with respect to all other processors and mechanisms that access the target locations coherently, before its next instruction is executed. A program can use this instruction to ensure that all updates to a shared data structure, accessed coherently, are visible to all other processors that access the data structure coherently, before executing a store that will release a lock on that data structure. Execution of the **sync** instruction does the following:

- Performs the functions described for the **sync** instruction in Section 4.2.6, “Memory Synchronization Instructions—UISA.”
- Ensures that consistency operations, and the effects of **icbi**, **dcbz**, **dcbst**, **dcbf**, **dcba**, and **dcbi** instructions previously executed by the processor executing **sync**, have completed on such other processors as the memory/cache access attributes of the target locations require.
- Ensures that TLB invalidate operations previously executed by the processor executing the **sync** have completed on that processor. The **sync** instruction does not wait for such invalidates to complete on other processors.
- Ensures that memory accesses due to instructions previously executed by the processor executing the **sync** are recorded in the R and C bits in the page table and that the new values of those bits are visible to all processors and mechanisms; refer to Section 7.5.3, “Page History Recording.”

The **sync** instruction is execution synchronizing. It is not context synchronizing, and therefore need not discard prefetched instructions.

For memory that does not require coherency, the **sync** instruction operates as described above except that its only effect on memory operations is to ensure that all previous memory operations have completed, with respect to the processor executing the **sync** instruction, to the level of memory specified by the memory/cache access attributes (including the updating of R and C bits).

5.1.2 Atomicity

An access is atomic if it is always performed in its entirety with no visible fragmentation. Atomic accesses are thus serialized—each happens in its entirety in some order, even when that order is neither specified in the program nor enforced between processors.

Only the following single-register accesses are guaranteed to be atomic:

- Byte accesses (all bytes are aligned on byte boundaries)
- Half-word accesses aligned on half-word boundaries
- Word accesses aligned on word boundaries
- Double-word accesses aligned on double-word boundaries (64-bit implementations only)

No other accesses are guaranteed to be atomic. In particular, the accesses caused by the following instructions are not guaranteed to be atomic:

- Load and store instructions with misaligned operands
- **lmw**, **stmw**, **lswi**, **lswx**, **stswi**, or **stswx** instructions
- Floating-point double-word accesses in 32-bit implementations
- Any cache management instructions

The **ldarx/stdcx.** and **lwarx/stwex.** instruction combinations can be used to perform atomic memory references. The **ldarx** instruction is a load from a double-word–aligned location that has two side effects:

1. A reservation for a subsequent **stdcx.** instruction is created.
2. The memory coherence mechanism is notified that a reservation exists for the memory location accessed by the **ldarx.**

The **stdcx.** instruction is a store to a double-word–aligned location that is conditioned on the existence of the reservation created by **ldarx** and on whether the same memory location is specified by both instructions and whether the instructions are issued by the same processor.

The **lwarx** and **stwex.** instructions are the word-aligned forms of the **ldarx** and **stwex.** instructions. To emulate an atomic operation with these instructions, it is necessary that both **ldarx** and **stdcx.** (or **lwarx** and **stwex.**) access the same memory location.

In a multiprocessor system, every processor (other than the one executing **ldarx/stdcx.** or **lwarx/stwcx.**) that might update the location must configure the addressed page as memory coherency required. The **ldarx/stdcx.** and **lwarx/stwcx.** instructions function in caching-inhibited, as well as in caching-allowed, memory. If the addressed memory is in write-through mode, it is implementation-dependent whether these instructions function correctly or cause the DSI exception handler to be invoked. (Note that exceptions are referred to as interrupts in the architecture specification.)

The **ldarx/stdcx.** and **lwarx/stwcx.** instruction combinations are described in Section 4.2.6, “Memory Synchronization Instructions—UISA,” and Chapter 8, “Instruction Set.”

5.1.3 Cache Model

The PowerPC architecture does not specify the type, organization, implementation, or even the existence of a cache. The standard cache model has separate instruction and data caches, also known as a Harvard cache model. However, the architecture allows for many different cache types. Some implementations will have a unified cache (where there is a single cache for both instructions and data). Other implementations may not have a cache at all.

The function of the cache management instructions depends on the implementation of the cache(s) and the setting of the memory/cache access modes. For a program to execute properly on all implementations, software should use the Harvard model. In cases where a processor is implemented without a cache, the architecture guarantees that instructions affecting the nonimplemented cache will not halt execution (note that **dcbz** may cause an alignment exception on some implementations). For example, a processor with no cache may treat a cache instruction as a no-op. Or, a processor with a unified cache may treat the **icbi** instruction as a no-op. In this manner, programs written for separate instruction and data caches will run on all compliant implementations.

5.1.4 Memory Coherency

The primary objective of a coherent memory system is to provide the same image of memory to all devices using the system. The VEA and OEA define coherency controls that facilitate synchronization, cooperative use of shared resources, and task migration among processors. These controls include the memory/cache access attributes, the **sync** and **eiio** instructions, and the **ldarx/stdcx.** and **lwarx/stwcx.** instruction pairs. Without these controls, the processor could not support a weakly-ordered memory access model.

A strongly-ordered memory access model hinders performance by requiring excessive overhead, particularly in multiprocessor environments. For example, a processor performing a store operation in a strongly-ordered system requires exclusive access to an address before making an update, to prevent another device from using stale data.

The VEA defines a page as a unit of memory for which protection and control attributes are independently specifiable. The OEA (supervisor level) specifies the size of a page as 4 Kbytes. It is important to note that the VEA (user level) does not specify the page size.

5.1.4.1 Memory/Cache Access Modes

The OEA defines the set of memory/cache access modes and the mechanism to implement these modes. Refer to Section 5.2.1, “Memory/Cache Access Attributes,” for more information. However, the VEA specifies that at the user level, the operating system can be expected to provide the following attributes for each page of memory:

- Write-through or write-back
- Caching-inhibited or caching-allowed
- Memory coherency required or memory coherency not required
- Guarded or not guarded

User-level programs specify the memory/cache access attributes through an operating system service.

5.1.4.1.1 Pages Designated as Write-Through

When a page is designated as write-through, store operations update the data in the cache and also update the data in main memory. The processor writes to the cache and through to main memory. Load operations use the data in the cache, if it is present.

In write-back mode, the processor is only required to update data in the cache. The processor may (but is not required to) update main memory. Load and store operations use the data in the cache, if it is present. The data in main memory does not necessarily stay consistent with that same location’s data in the cache. Many implementations automatically update main memory in response to a memory access by another device (for example, a snoop hit). In addition, the **dcbst** and **dcbf** instructions can be used to explicitly force an update of main memory.

The write-through attribute is meaningless for locations designated as caching-inhibited.

5.1.4.1.2 Pages Designated as Caching-Inhibited

When a page is designated as caching-inhibited, the processor bypasses the cache and performs load and store operations to main memory. When a page is designated as caching-allowed, the processor uses the cache and performs load and store operations to the cache or main memory depending on the other memory/cache access attributes for the page.

It is important that all locations in a page are purged from the cache prior to changing the memory/cache access attribute for the page from caching-allowed to caching-inhibited. It is considered a programming error if a caching-inhibited memory location is found in the cache. Software must ensure that the location has not previously been brought into the cache, or, if it has, that it has been flushed from the cache. If the programming error occurs, the result of the access is boundedly undefined.

5.1.4.1.3 Pages Designated as Memory Coherency Required

When a page is designated as memory coherency required, store operations to that location are serialized with all stores to that same location by all other processors that also access the location coherently. This can be implemented, for example, by an ownership protocol that allows at most one processor at a time to store to the location. Moreover, the current copy of a cache block that is in this mode may be copied to main storage any number of times, for example, by successive **dcbst** instructions.

Coherency does not ensure that the result of a store by one processor is visible immediately to all other processors and mechanisms. Only after a program has executed the **sync** instruction are the previous storage accesses it executed guaranteed to have been performed with respect to all other processors and mechanisms.

5.1.4.1.4 Pages Designated as Memory Coherency Not Required

For a memory area that is configured such that coherency is not required, software must ensure that the data cache is consistent with main storage before changing the mode or allowing another device to access the area.

Executing a **dcbst** or **dcbf** instruction specifying a cache block that is in this mode causes the block to be copied to main memory if and only if the processor modified the contents of a location in the block and the modified contents have not been written to main memory.

In a single-cache system, correct coherent execution may likely not require memory coherency; therefore, using memory coherency not required mode improves performance.

5.1.4.1.5 Pages Designated as Guarded

The guarded attribute pertains to out-of-order execution. Refer to Section 5.2.1.5.3, “Out-of-Order Accesses to Guarded Memory,” for more information about out-of-order execution.

When a page is designated as guarded, instructions and data cannot be accessed out of order. Additionally, if separate store instructions access memory that is both caching-inhibited and guarded, the accesses are performed in the order specified by the program. When a page is designated as not guarded, out-of-order fetches and accesses are allowed.

5.1.4.2 Coherency Precautions

Mismatched memory/cache attributes cause coherency paradoxes in both single-processor and multiprocessor systems. When the memory/cache access attributes are changed, it is critical that the cache contents reflect the new attribute settings. For example, if a block or page that had allowed caching becomes caching-inhibited, the appropriate cache blocks should be flushed to leave no indication that caching had previously been allowed.

Although coherency paradoxes are considered programming errors, specific implementations may attempt to handle the offending conditions and minimize the negative effects on memory coherency. Bus operations that are generated for specific instructions and state conditions are not defined by the architecture.

5.1.5 VEA Cache Management Instructions

The VEA defines instructions for controlling both the instruction and data caches. For implementations that have a unified instruction/data cache, instruction cache control instructions are valid instructions, but may function differently.

Note that any cache control instruction that generates an EA that corresponds to a direct-store segment ($SR[T] = 1$ or $STE[T] = 1$) is treated as a no-op. However, the direct-store facility is being phased out of the architecture and will not likely be supported in future devices. Thus, software should not depend on its effects.

This section briefly describes the cache management instructions available to programs at the user privilege level. Additional descriptions of coding the VEA cache management instructions is provided in Chapter 4, “Addressing Modes and Instruction Set Summary,” and Chapter 8, “Instruction Set.” In the following instruction descriptions, the target is the cache block containing the byte addressed by the effective address.

5.1.5.1 Data Cache Instructions

Data caches and unified caches must be consistent with other caches (data or unified), memory, and I/O data transfers. To ensure consistency, aliased effective addresses (two effective addresses that map to the same physical address) must have the same page offset. Note that physical address is referred to as real address in the architecture specification.

5.1.5.1.1 Data Cache Block Touch (dcbt) and Data Cache Block Touch for Store (dcbtst) Instructions

These instructions provide a method for improving performance through the use of software-initiated prefetch hints. However, these instructions do not guarantee that a cache block will be fetched.

A program uses the **dcbt** instruction to request a cache block fetch before it is needed by the program. The program can then use the data from the cache rather than fetching from main memory.

The **dcbtst** instruction behaves similarly to the **dcbt** instruction. A program uses **dcbtst** to request a cache block fetch to guarantee that a subsequent store will be to a cached location.

The processor does not invoke the exception handler for translation or protection violations caused by either of the touch instructions. Additionally, memory accesses caused by these instructions are not necessarily recorded in the page tables. If an access is recorded, then it is treated in a manner similar to that of a load from the addressed byte. Some implementations may not take any action based on the execution of these instructions, or they may prefetch the cache block corresponding to the EA into their cache. For information about the R and C bits, see Section 7.5.3, “Page History Recording.”

Both **dcbt** and **dcbst** are provided for performance optimization. These instructions do not affect the correct execution of a program, regardless of whether they succeed (fetch the cache block) or fail (do not fetch the cache block). If the target block is not accessible to the program for loads, then no operation occurs.

5.1.5.1.2 Data Cache Block Set to Zero (**dcbz**) Instruction

The **dcbz** instruction clears a single cache block as follows:

- If the target is in the data cache, all bytes of the cache block are cleared.
- If the target is not in the data cache and the corresponding page is caching-allowed, the cache block is established in the data cache (without fetching the cache block from main memory), and all bytes of the cache block are cleared.
- If the target is designated as either caching-inhibited or write-through, then either all bytes in main memory that correspond to the addressed cache block are cleared, or the alignment exception handler is invoked. The exception handler should clear all the bytes in main memory that correspond to the addressed cache block.
- If the target is designated as coherency required, and the cache block exists in the data cache(s) of any other processor(s), it is kept coherent in those caches.

The **dcbz** instruction is treated as a store to the addressed byte with respect to address translation, protection, referenced and changed recording, and the ordering enforced by **eiio** or by the combination of caching-inhibited and guarded attributes for a page.

Refer to Chapter 6, “Exceptions,” for more information about a possible delayed machine check exception that can occur by using **dcbz** when the operating system has set up an incorrect memory mapping.

5.1.5.1.3 Data Cache Block Store (**dcbst**) Instruction

The **dcbst** instruction permits the program to ensure that the latest version of the target cache block is in main memory. The **dcbst** instruction executes as follows:

- Coherency required—If the target exists in the data cache(s) of any processor(s) and has been modified, the data is written to main memory.
- Coherency not required—If the target exists in the data cache of the executing processor and has been modified, the data is written to main memory.

The function of this instruction is independent of the write-through/write-back and caching-inhibited/caching-allowed attributes of the target.

The memory access caused by a **dcbst** instruction is not necessarily recorded in the page tables. If the access is recorded, then it is treated as a load operation (not as a store operation).

5.1.5.1.4 Data Cache Block Flush (dcbf) Instruction

The action taken depends on the memory/cache access mode associated with the target, and on the state of the cache block. The following list describes the action taken for the various cases:

- Coherency required
 - Unmodified cache block—Invalidates copies of the cache block in the data caches of all processors.
 - Modified cache block—Copies the cache block to memory. Invalidates copies of the cache block in the data caches of all processors.
 - Target block not in cache—If a modified copy of the cache block is in the data cache(s) of any processor(s), **dcbf** causes the modified cache block to be copied to memory and then invalidated. If unmodified copies are in the data caches of other processors, **dcbf** causes those copies to be invalidated.
- Coherency not required
 - Unmodified cache block—Invalidates the cache block in the executing processor's data cache.
 - Modified cache block—Copies the data cache block to memory and then invalidates the cache block in the executing processor.
 - Target block not in cache—No action is taken.

The function of this instruction is independent of the write-through/write-back and caching-inhibited/caching-allowed attributes of the target.

The memory access caused by a **dcbf** instruction is not necessarily recorded in the page tables. If the access is recorded, then it is treated as a load operation (not as a store operation).

5.1.5.2 Instruction Cache Instructions

Instruction caches, if they exist, are not required to be consistent with data caches, memory, or I/O data transfers. Software must use the appropriate cache management instructions to ensure that instruction caches are kept coherent when instructions are modified by the processor or by input data transfer. When a processor alters a memory location that may be contained in an instruction cache, software must ensure that updates to memory are visible to the instruction fetching mechanism. Although the instructions to enforce consistency vary among implementations, the following sequence for a uniprocessor system is typical:

1. **dcbst** (update memory)
2. **sync** (wait for update)
3. **icbi** (invalidate copy in instruction cache)
4. **isync** (perform context synchronization)

Note that most operating systems will provide a system service for this function. These operations are necessary because the memory may be designated as write-back. Since instruction fetching may bypass the data cache, changes made to items in the data cache may not otherwise be reflected in memory until after the instruction fetch completes.

For implementations used in multiprocessor systems, variations on this sequence may be recommended. For example, in a multiprocessor system with a unified instruction/data cache (at any level), if instructions are fetched without coherency being enforced, the preceding instruction sequence is inadequate. Because the **icbi** instruction does not invalidate blocks in a unified cache, a **dcbf** instruction should be used instead of a **dcbst** instruction for this case.

5.1.5.2.1 Instruction Cache Block Invalidate Instruction (**icbi**)

The **icbi** instruction executes as follows:

- Coherency required
If the target is in the instruction cache of any processor, the cache block is made invalid in all such processors, so that the next reference causes the cache block to be refetched.
- Coherency not required
If the target is in the instruction cache of the executing processor, the cache block is made invalid in the executing processor so that the next reference causes the cache block to be refetched.

The **icbi** instruction is provided for use in processors with separate instruction and data caches. The effective address is computed, translated, and checked for protection violations as defined in Chapter 7, “Memory Management.” If the target block is not accessible to the program for loads, then a DSI exception occurs.

The function of this instruction is independent of the write-through/write-back and caching-inhibited/caching-allowed attributes of the target.

The memory access caused by an **icbi** instruction is not necessarily recorded in the page tables. If the access is recorded, then it is treated as a load operation. Implementations that have a unified cache treat the **icbi** instruction as a no-op except that they may invalidate the target cache block in the instruction caches of other processors (in coherency required mode).

5.1.5.2.2 Instruction Synchronize Instruction (**isync**)

The **isync** instruction provides an ordering function for the effects of all instructions executed by a processor. Executing an **isync** instruction ensures that all instructions preceding the **isync** instruction have completed before the **isync** instruction completes, except that memory accesses caused by those instructions need not have been performed with respect to other processors and mechanisms. It also ensures that no subsequent instructions are initiated by the processor until after the **isync** instruction completes.

Finally, it causes the processor to discard any prefetched instructions, with the effect that subsequent instructions will be fetched and executed in the context established by the instructions preceding the **isync** instruction. The **isync** instruction has no effect on other processors or on their caches.

5.2 The Operating Environment

The OEA defines the mechanism for controlling the memory/cache access modes introduced in Section 5.1.4.1, “Memory/Cache Access Modes.” This section describes the cache-related aspects of the OEA including the memory/cache access attributes, out-of-order execution, direct-store interface considerations, and the **dcbi** instruction. The features of the OEA are accessible to supervisor-level applications only. The mechanism for controlling the virtual memory space is described in Chapter 7, “Memory Management.”

The memory model of PowerPC processors provides the following features:

- Flexibility to allow performance benefits of weakly-ordered memory access
- A mechanism to maintain memory coherency among processors and between a processor and I/O devices controlled at the block and page level
- Instructions that can be used to ensure a consistent memory state
- Guaranteed processor access order

The memory implementations in PowerPC systems can take advantage of the performance benefits of weak ordering of memory accesses between processors or between processors and other external devices without any additional complications. Memory coherency can be enforced externally by a snooping bus design, a centralized cache directory design, or other designs that can take advantage of the coherency features of PowerPC processors.

Memory accesses performed by a single processor appear to complete sequentially from the view of the programming model but may complete out of order with respect to the ultimate destination in the memory hierarchy. Order is guaranteed at each level of the memory hierarchy for accesses to the same address from the same processor. The **dcbst**, **dcbf**, **icbi**, **isync**, **sync**, **eieio**, **ldarx**, **stdcx.**, **lwarx**, and **stwcx.** instructions allow the programmer to ensure a consistent memory state.

5.2.1 Memory/Cache Access Attributes

All instruction and data accesses are performed under the control of the four memory/cache access attributes:

- Write-through (W attribute)
- Caching-inhibited (I attribute)
- Memory coherency (M attribute)
- Guarded (G attribute)

These attributes are programmed in the PTEs and BATs by the operating system for each page and block respectively. The W and I attributes control how the processor performing an access uses its own cache. The M attribute ensures that coherency is maintained for all copies of the addressed memory location. When an access requires coherency, the processor performing the access must inform the coherency mechanisms throughout the system that the access requires memory coherency. The G attribute prevents out-of-order loading and prefetching from the addressed memory location.

Note that the memory/cache access attributes are relevant only when an effective address is translated by the processor performing the access. Note also that not all combinations of settings of these bits is supported. The attributes are not saved along with data in the cache (for cacheable accesses), nor are they associated with subsequent accesses made by other processors.

The operating system programs the memory/cache access attribute for each page or block as required. The WIMG attributes occupy four bits in the BAT registers for block address translation and in the PTEs for page address translation. The WIMG bits are programmed as follows:

- The operating system uses the **mtspr** instruction to program the WIMG bits in the BAT registers for block address translation. The IBAT register pairs implement the W or G bits; however, attempting to set either bit in IBAT registers causes boundedly-undefined results.
- The operating system writes the WIMG bits for each page into the PTEs in system memory as it sets up the page tables.

Note that for data accesses performed in real addressing mode ($MSR[DR] = 0$), the WIMG bits are assumed to be 0b0011 (the data is write-back, caching is enabled, memory coherency is enforced, and memory is guarded). For instruction accesses performed in real addressing mode ($MSR[IR] = 0$), the WIMG bits are assumed to be 0b0001 (the data is write-back, caching is enabled, memory coherency is not enforced, and memory is guarded).

5.2.1.1 Write-Through Attribute (W)

When an access is designated as write-through ($W = 1$), if the data is in the cache, a store operation updates the cached copy of the data. In addition, the update is written to the memory location. The definition of the memory location to be written to (in addition to the cache) depends on the implementation of the memory system but can be illustrated by the following examples:

- RAM—The store is sent to the RAM controller to be written into the target RAM.
- I/O device—The store is sent to the memory-mapped I/O controller to be written to the target register or memory location.

In systems with multilevel caching, the store must be written to at least a depth in the memory hierarchy that is seen by all processors and devices.

Multiple store instructions may be combined for write-through accesses except when the store instructions are separated by a **sync** or **eieio** instruction. A store operation to a memory location designated as write-through may cause any part of the cache block to be written back to main memory.

Accesses that correspond to $W = 0$ are considered write-back. For this case, although the store operation is performed to the cache, the data is copied to memory only when a copy-back operation is required. Use of the write-back mode ($W = 0$) can improve overall performance for areas of the memory space that are seldom referenced by other processors or devices in the system.

Accesses to the same memory location using two effective addresses for which the W bit setting differs meet the memory-coherency requirements if the accesses are performed by a single processor. If the accesses are performed by two or more processors, coherence is enforced by the hardware only if the write-through attribute is the same for all the accesses.

5.2.1.2 Caching-Inhibited Attribute (I)

If $I = 1$, the memory access is completed by referencing the location in main memory, bypassing the cache. During the access, the addressed location is not loaded into the cache nor is the location allocated in the cache.

It is considered a programming error if a copy of the target location of an access to caching-inhibited memory is resident in the cache. Software must ensure that the location has not been previously loaded into the cache, or, if it has, that it has been flushed from the cache.

Data accesses from more than one instruction may be combined for cache-inhibited operations, except when the accesses are separated by a **sync** instruction, or by an **eieio** instruction when the page or block is also designated as guarded.

Instruction fetches, **dcbz** instructions, and load and store operations to the same memory location using two effective addresses for which the I bit setting differs must meet the requirement that a copy of the target location of an access to caching-inhibited memory not be in the cache. Violation of this requirement is considered a programming error; software must ensure that the location has not previously been brought into the cache or, if it has, that it has been flushed from the cache. If the programming error occurs, the result of the access is boundedly undefined. It is not considered a programming error if the target location of any other cache management instruction to caching-inhibited memory is in the cache.

5.2.1.3 Memory Coherency Attribute (M)

This attribute is provided to allow improved performance in systems where hardware-enforced coherency is relatively slow, and software is able to enforce the required coherency. When $M = 0$, there are no requirements to enforce data coherency. When $M = 1$, the processor enforces data coherency.

When the M attribute is set, and the access is performed to memory, there is a hardware indication to the rest of the system that the access is global. Other processors affected by the access must then respond to this global access. For example, in a snooping bus design, the processor may assert some type of global access signal. Other processors affected by the access respond and signal whether the data is being shared. If the data in another processor is modified, then the location is updated and the access is retried.

Because instruction memory does not have to be coherent with data memory, some implementations may ignore the M attribute for instruction accesses. In a single-processor (or single-cache) system, performance might be improved by designating all pages as memory coherency not required.

Accesses to the same memory location using two effective addresses for which the M bit settings differ may require explicit software synchronization before accessing the location with $M = 1$ if the location has previously been accessed with $M = 0$. Any such requirement is system-dependent. For example, no software synchronization may be required for systems that use bus snooping. In some directory-based systems, software may be required to execute **dcbf** instructions on each processor to flush all storage locations accessed with $M = 0$ before accessing those locations with $M = 1$.

5.2.1.4 W, I, and M Bit Combinations

Table 5-1 summarizes the six combinations of the WIM bits supported by the OEA. The combinations where $WIM = 11x$ are not supported. Note that either a zero or one setting for the G bit is allowed for each of these WIM bit combinations.

Table 5-1. Combinations of W, I, and M Bits

WIM Setting	Meaning
000	The processor may cache data (or instructions). A load or store operation whose target hits in the cache may use that entry in the cache. The processor does not need to enforce memory coherency for accesses it initiates.
001	Data (or instructions) may be cached. A load or store operation whose target hits in the cache may use that entry in the cache. The processor enforces memory coherency for accesses it initiates.
010	Caching is inhibited. The access is performed to memory, completely bypassing the cache. The processor does not need to enforce memory coherency for accesses it initiates.
011	Caching is inhibited. The access is performed to memory, completely bypassing the cache. The processor enforces memory coherency for accesses it initiates.

Table 5-1. Combinations of W, I, and M Bits (Continued)

WIM Setting	Meaning
100	Data (or instructions) may be cached. A load operation whose target hits in the cache may use that entry in the cache. Store operations are written to memory. The target location of the store may be cached and is updated on a hit. The processor does not need to enforce memory coherency for accesses it initiates.
101	Data (or instructions) may be cached. A load operation whose target hits in the cache may use that entry in the cache. Store operations are written to memory. The target location of the store may be cached and is updated on a hit. The processor enforces memory coherency for accesses it initiates.

5.2.1.5 The Guarded Attribute (G)

When the guarded bit is set, the memory area (block or page) is designated as guarded. This setting can be used to protect certain memory areas from read accesses made by the processor that are not dictated directly by the program. If there are areas of physical memory that are not fully populated (in other words, there are holes in the physical memory map within this area), this setting can protect the system from undesired accesses caused by out-of-order load operations or instruction prefetches that could lead to the generation of the machine check exception. Also, the guarded bit can be used to prevent out-of-order (speculative) load operations or prefetches from occurring to certain peripheral devices that produce undesired results when accessed in this way.

5.2.1.5.1 Performing Operations Out of Order

An operation is said to be performed in-order if it is guaranteed to be required by the sequential execution model. Any other operation is said to be performed out of order.

Operations are performed out of order by the hardware on the expectation that the results will be needed by an instruction that will be required by the sequential execution model. Whether the results are really needed is contingent on everything that might divert the control flow away from the instruction, such as branch, trap, system call, and **rfi** instructions, and exceptions, and on everything that might change the context in which the instruction is executed.

Typically, the hardware performs operations out of order when it has resources that would otherwise be idle, so the operation incurs little or no cost. If subsequent events such as branches or exceptions indicate that the operation would not have been performed in the sequential execution model, the processor abandons any results of the operation (except as described below).

Most operations can be performed out of order, as long as the machine appears to follow the sequential execution model. Certain out-of-order operations are restricted, as follows.

- Stores
A store instruction may not be executed out of order in a manner such that the alteration of the target location can be observed by other processors or mechanisms.
- Accessing guarded memory
The restrictions for this case are given in Section 5.2.1.5.3, “Out-of-Order Accesses to Guarded Memory.”

No error of any kind other than a machine check exception may be reported due to an operation that is performed out of order, until such time as it is known that the operation is required by the sequential execution model. The only other permitted side effects (other than machine check) of performing an operation out of order are the following:

- Referenced and changed bits may be set as described in Section 7.2.5, “Page History Information.”
- Nonguarded memory locations that could be fetched into a cache by in-order execution may be fetched out of order into that cache.

5.2.1.5.2 Guarded Memory

Memory is said to be well behaved if the corresponding physical memory exists and is not defective, and if the effects of a single access to it are indistinguishable from the effects of multiple identical accesses to it. Data and instructions can be fetched out of order from well-behaved memory without causing undesired side effects.

Memory is said to be guarded if either (a) the G bit is 1 in the relevant PTE or DBAT register, or (b) the processor is in real addressing mode ($MSR[IR] = 0$ or $MSR[DR] = 0$ for instruction fetches or data accesses respectively). In case (b), all of memory is guarded for the corresponding accesses. In general, memory that is not well-behaved should be guarded. Because such memory may represent an I/O device or may include locations that do not exist, an out-of-order access to such memory may cause an I/O device to perform incorrect operations or may result in a machine check.

Note that if separate store instructions access memory that is both caching-inhibited and guarded, the accesses are performed in the order specified by the program. If an aligned, elementary load or store to caching-inhibited, guarded memory has accessed main memory and an external, decremter, or imprecise-mode floating-point enabled exception is pending, the load or store is completed before the exception is taken.

5.2.1.5.3 Out-of-Order Accesses to Guarded Memory

The circumstances in which guarded memory may be accessed out of order are as follows:

- Load instruction

If a copy of the target location is in a cache, the location may be accessed in the cache or in main memory.

- Instruction fetch

In real addressing mode ($MSR[IR] = 0$), an instruction may be fetched if any of the following conditions is met:

- The instruction is in a cache. In this case, it may be fetched from that cache.
- The instruction is in the same physical page as an instruction that is required by the sequential execution model or is in the physical page immediately following such a page.

If $MSR[IR] = 1$, instructions may not be fetched from either no-execute segments or guarded memory. If the effective address of the current instruction is mapped to either of these kinds of memory when $MSR[IR] = 1$, an ISI exception is generated. However, it is permissible for an instruction from either of these kinds of memory to be in the instruction cache if it was fetched into that cache when its effective address was mapped to some other kind of memory. Thus, for example, the operating system can access an application's instruction segments as no-execute without having to invalidate them in the instruction cache.

Additionally, instructions are not fetched from direct-store segments (only applies when $MSR[IR] = 1$). If an instruction fetch is attempted from a direct-store segment, an ISI exception is generated. Note that the direct-store facility is being phased out of the architecture and will not likely be supported in future devices. Thus, software should not depend on its effects.

Note that software should ensure that only well-behaved memory is loaded into a cache, either by marking as caching-inhibited (and guarded) all memory that may not be well-behaved, or by marking such memory caching-allowed (and guarded) and referring only to cache blocks that are well-behaved.

If a physical page contains instructions that will be executed in real addressing mode ($MSR[IR] = 0$), software should ensure that this physical page and the next physical page contain only well-behaved memory.

5.2.2 I/O Interface Considerations

The PowerPC architecture defines two mechanisms for accessing I/O:

- Memory-mapped I/O interface operations. $SR[T] = 0$ or $STE[T] = 0$. These operations are considered to address memory space and are therefore subject to the same coherency control as memory accesses. Depending on the specific I/O interface, the memory/cache access attributes (WIMG) and the degree of access ordering (requiring **ei** or **sync** instructions) need to be considered. This is the recommended way of accessing I/O.
- Direct-store segment operations. $SR[T] = 1$ or $STE[T] = 1$. These operations are considered to address the noncoherent and noncacheable direct-store segment space; therefore, hardware need not maintain coherency for these operations, and the cache is bypassed completely. Although the architecture defines this direct-store functionality, it is being phased out of the architecture and will not likely be supported in future devices. Thus, its use is discouraged, and new software should not use it or depend on its effects.

5.2.3 OEA Cache Management Instruction— Data Cache Block Invalidate (**dcbi**)

As described in Section 5.1.5, “VEA Cache Management Instructions,” the VEA defines instructions for controlling both the instruction and data caches. The OEA defines one instruction, the data cache block invalidate (**dcbi**) instruction, for controlling the data cache. This section briefly describes the cache management instruction available to programs at the supervisor privilege level. Additional descriptions of coding the **dcbi** instruction are provided in Chapter 4, “Addressing Modes and Instruction Set Summary,” and Chapter 8, “Instruction Set.” In the following description, the target is the cache block containing the byte addressed by the effective address.

Any cache management instruction that generates an EA that corresponds to a direct-store segment ($SR[T] = 1$ or $STE[T] = 1$) is treated as a no-op. However, note that the direct-store facility is being phased out of the architecture and will not likely be supported in future devices. Thus, software should not depend on its effects.

The action taken depends on the memory/cache access mode associated with the target, and on the state of the cache block. The following list describes the action taken for the various cases:

- Coherency required
 - Unmodified cache block—Invalidates copies of the cache block in the data caches of all processors.
 - Modified cache block—Invalidates copies of the cache block in the data caches of all processors. (Discards the modified data in the cache block.)

Target block not in cache—If copies of the target are in the data caches of other processors, **dcbi** causes those copies to be invalidated, regardless of whether the data is modified or unmodified.

- Coherency not required

Unmodified cache block—Invalidates the cache block in the executing processor's data cache.

Modified cache block—Invalidates the cache block in the executing processor's data cache. (Discards the modified data in the cache block.)

Target block not in cache—No action is taken.

The processor treats the **dcbi** instruction as a store to the addressed byte with respect to address translation and protection. It is not necessary to set the referenced and changed bits.

The function of this instruction is independent of the write-through/write-back and caching-inhibited/caching-allowed attributes of the target. To ensure coherency, aliased effective addresses (two effective addresses that map to the same physical address) must have the same page offset.

Chapter 6 Exceptions

The operating environment architecture (OEA) portion of the PowerPC architecture defines the mechanism by which PowerPC processors implement exceptions (referred to as interrupts in the architecture specification). Exception conditions may be defined at other levels of the architecture. For example, the user instruction set architecture (UISA) defines conditions that may cause floating-point exceptions; the OEA defines the mechanism by which the exception is taken.

The PowerPC exception mechanism allows the processor to change to supervisor state as a result of external signals, errors, or unusual conditions arising in the execution of instructions. When exceptions occur, information about the state of the processor is saved to certain registers and the processor begins execution at an address (exception vector) predetermined for each exception. Processing of exceptions begins in supervisor mode.

Although multiple exception conditions can map to a single exception vector, a more specific condition may be determined by examining a register associated with the exception—for example, the DSISR and the floating-point status and control register (FPSCR). Additionally, certain exception conditions can be explicitly enabled or disabled by software.

The PowerPC architecture requires that exceptions be taken in program order; therefore, although a particular implementation may recognize exception conditions out of order, they are handled strictly in order with respect to the instruction stream. When an instruction-caused exception is recognized, any unexecuted instructions that appear earlier in the instruction stream, including any that have not yet entered the execute state, are required to complete before the exception is taken. For example, if a single instruction encounters multiple exception conditions, those exceptions are taken and handled sequentially. Likewise, exceptions that are asynchronous and precise are recognized when they occur, but are not handled until all instructions currently in the execute stage successfully complete execution and report their results.

Note that exceptions can occur while an exception handler routine is executing, and multiple exceptions can become nested. It is up to the exception handler to save the appropriate machine state if it is desired to allow control to ultimately return to the excepting program.

In many cases, after the exception handler handles an exception, there is an attempt to execute the instruction that caused the exception. Instruction execution continues until the next exception condition is encountered. This method of recognizing and handling exception conditions sequentially guarantees that the machine state is recoverable and processing can resume without losing instruction results.

To prevent the loss of state information, exception handlers must save the information stored in SRR0 and SRR1 soon after the exception is taken to prevent this information from being lost due to another exception being taken.

In this chapter, the following terminology is used to describe the various stages of exception processing:

Recognition	Exception recognition occurs when the condition that can cause an exception is identified by the processor.
Taken	An exception is said to be taken when control of instruction execution is passed to the exception handler; that is, the context is saved and the instruction at the appropriate vector offset is fetched and the exception handler routine is begun in supervisor mode.
Handling	Exception handling is performed by the software linked to the appropriate vector offset. Exception handling is begun in supervisor mode (referred to as privileged state in the architecture specification).

6.1 Exception Classes

As specified by the PowerPC architecture, all exceptions can be described as either precise or imprecise and either synchronous or asynchronous. Asynchronous exceptions are caused by events external to the processor's execution; synchronous exceptions are caused by instructions.

The PowerPC exception types are shown in Table 6-1.

Table 6-1. PowerPC Exception Classifications

Type	Exception
Asynchronous/nonmaskable	Machine Check System Reset
Asynchronous/maskable	External interrupt Decrementer
Synchronous/Precise	Instruction-caused exceptions, excluding floating-point imprecise exceptions
Synchronous/Imprecise	Instruction-caused imprecise exceptions (Floating-point imprecise exceptions)

Exceptions, their offsets, and conditions that cause them, are summarized in Table 6-2. The exception vectors described in the table correspond to physical address locations, depending on the value of MSR[IP]. Refer to Section 7.2.1.2, "Predefined Physical Memory Locations," for a complete list of the predefined physical memory areas. Remaining sections in this chapter provide more complete descriptions of the exceptions and of the conditions that cause them.

Table 6-2. Exceptions and Conditions—Overview

Exception Type	Vector Offset (hex)	Causing Conditions
System reset	00100	The causes of system reset exceptions are implementation-dependent. If the conditions that cause the exception also cause the processor state to be corrupted such that the contents of SRR0 and SRR1 are no longer valid or such that other processor resources are so corrupted that the processor cannot reliably resume execution, the copy of the RI bit copied from the MSR to SRR1 is cleared.
Machine check	00200	The causes for machine check exceptions are implementation-dependent, but typically these causes are related to conditions such as bus parity errors or attempting to access an invalid physical address. Typically, these exceptions are triggered by an input signal to the processor. Note that not all processors provide the same level of error checking. The machine check exception is disabled when MSR[ME] = 0. If a machine check exception condition exists and the ME bit is cleared, the processor goes into the checkstop state. If the conditions that cause the exception also cause the processor state to be corrupted such that the contents of SRR0 and SRR1 are no longer valid or such that other processor resources are so corrupted that the processor cannot reliably resume execution, the copy of the RI bit written from the MSR to SRR1 is cleared. (Note that physical address is referred to as real address in the architecture specification.)
DSI	00300	A DSI exception occurs when a data memory access cannot be performed for any of the reasons described in Section 6.4.3, "DSI Exception (0x00300)." Such accesses can be generated by load/store instructions, certain memory control instructions, and certain cache control instructions.
ISI	00400	An ISI exception occurs when an instruction fetch cannot be performed for a variety of reasons described in Section 6.4.4, "ISI Exception (0x00400)."
External interrupt	00500	An external interrupt is generated only when an external interrupt is pending (typically signalled by a signal defined by the implementation) and the interrupt is enabled (MSR[EE] = 1).
Alignment	00600	An alignment exception may occur when the processor cannot perform a memory access for reasons described in Section 6.4.6, "Alignment Exception (0x00600)." Note that an implementation is allowed to perform the operation correctly and not cause an alignment exception.

Table 6-2. Exceptions and Conditions—Overview (Continued)

Exception Type	Vector Offset (hex)	Causing Conditions
Program	00700	<p>A program exception is caused by one of the following exception conditions, which correspond to bit settings in SRR1 and arise during execution of an instruction:</p> <ul style="list-style-type: none"> • Floating-point enabled exception—A floating-point enabled exception condition is generated when $MSR[FE0-FE1] \neq 00$ and $FPSCR[FEX]$ is set. The settings of FE0 and FE1 are described in Table 6-3. $FPSCR[FEX]$ is set by the execution of a floating-point instruction that causes an enabled exception or by the execution of a Move to FPSCR instruction that sets both an exception condition bit and its corresponding enable bit in the FPSCR. These exceptions are described in Section 3.3.6, “Floating-Point Program Exceptions.” • Illegal instruction—An illegal instruction program exception is generated when execution of an instruction is attempted with an illegal opcode or illegal combination of opcode and extended opcode fields or when execution of an optional instruction not provided in the specific implementation is attempted (these do not include those optional instructions that are treated as no-ops). The PowerPC instruction set is described in Chapter 4, “Addressing Modes and Instruction Set Summary.” See Section 6.4.7, “Program Exception (0x00700),” for a complete list of causes for an illegal instruction program exception. • Privileged instruction—A privileged instruction type program exception is generated when the execution of a privileged instruction is attempted and the MSR user privilege bit, $MSR[PR]$, is set. This exception is also generated for $mtspr$ or $mfspr$ with an invalid SPR field if $spr[0] = 1$ and $MSR[PR] = 1$. • Trap—A trap type program exception is generated when any of the conditions specified in a trap instruction is met. <p>For more information, refer to Section 6.4.7, “Program Exception (0x00700).”</p>
Floating-point unavailable	00800	A floating-point unavailable exception is caused by an attempt to execute a floating-point instruction (including floating-point load, store, and move instructions) when the floating-point available bit is cleared, $MSR[FP] = 0$.
Decrementer	00900	The decrementer interrupt exception is taken if the exception is enabled ($MSR[EE] = 1$), and it is pending. The exception is created when the most-significant bit of the decrementer changes from 0 to 1. If it is not enabled, the exception remains pending until it is taken.
Reserved	00A00	This is reserved for implementation-specific exceptions. For example, the 601 uses this vector offset for direct-store exceptions.
Reserved	00B00	—
System call	00C00	A system call exception occurs when a System Call (sc) instruction is executed.
Trace	00D00	Implementation of the trace exception is optional. If implemented, it occurs if either the $MSR[SE] = 1$ and almost any instruction successfully completed or $MSR[BE] = 1$ and a branch instruction is completed. See Section 6.4.11, “Trace Exception (0x00D00),” for more information.
Floating-point assist	00E00	Implementation of the floating-point assist exception is optional. This exception can be used to provide software assistance for infrequent and complex floating-point operations such as denormalization.
Reserved	00E10–00FFF	—
Reserved	01000–02FFF	This is reserved for implementation-specific purposes. May be used for implementation-specific exception vectors or other uses.

6.1.1 Precise Exceptions

When any precise exceptions occur, SRR0 is set to point to an instruction such that all prior instructions in the instruction stream have completed execution and no subsequent instruction has begun execution. However, depending on the exception type, the instruction addressed by SRR0 may not have completed execution.

When an exception occurs, instruction dispatch (the issuance of instructions by the instruction fetch unit to any instruction execution mechanism) is halted and the following synchronization is performed:

1. The exception mechanism waits for all previous instructions in the instruction stream to complete to a point where they report all exceptions they will cause.
2. The processor ensures that all previous instructions in the instruction stream complete in the context in which they began execution.
3. The exception mechanism implemented in hardware and the software handler is responsible for saving and restoring the processor state.

The synchronization described conforms to the requirements for context synchronization. A complete description of context synchronization is described in the following section.

6.1.2 Synchronization

The synchronization described in this section refers to the state of activities within the processor that performs the synchronization.

6.1.2.1 Context Synchronization

An instruction or event is context synchronizing if it satisfies all the requirements listed below. Such instructions and events are collectively called context-synchronizing operations. Examples of context-synchronizing operations include the **sc** and **rfd** (or **rft**) instructions and most exceptions. A context-synchronizing operation has the following characteristics:

1. The operation causes instruction dispatching (the issuance of instructions by the instruction fetch mechanism to any instruction execution mechanism) to be halted.
2. The operation is not initiated or, in the case of **isync**, does not complete, until all instructions in execution have completed to a point at which they have reported all exceptions they will cause.

If a prior memory access instruction causes one or more direct-store interface error exceptions, the results are guaranteed to be determined before this instruction is executed. However, note that the direct-store facility is being phased out of the architecture and will not likely be supported in future devices.

3. Instructions that precede the operation complete execution in the context (for example, the privilege, translation mode, and memory protection) in which they were initiated.

4. If the operation either directly causes an exception (for example, the **sc** instruction causes a system call exception) or is an exception, the operation is not initiated until no exception exists having higher priority than the exception associated with the context-synchronizing operation.

A context-synchronizing operation is necessarily execution synchronizing. Unlike the **sync** instruction, a context-synchronizing operation need not wait for memory-related operations to complete on other processors, or for referenced and changed bits in the page table to be updated.

6.1.2.2 Execution Synchronization

An instruction is execution synchronizing if it satisfies the conditions of the first two items described above for context synchronization. The **sync** instruction is treated like **isync** with respect to the second item described above (that is, the conditions described in the second item apply to the completion of **sync**). The **sync** and **mtmsr** instructions are examples of execution-synchronizing instructions.

All context-synchronizing instructions are execution-synchronizing. Unlike a context-synchronizing operation, an execution-synchronizing instruction need not ensure that the subsequent instructions execute in the context established by that instruction. This new context becomes effective sometime after the execution-synchronizing instruction completes and before or at a subsequent context-synchronizing operation.

6.1.2.3 Synchronous/Precise Exceptions

When instruction execution causes a precise exception, the following conditions exist at the exception point:

- Depending on the type of exception, **SRR0** addresses either the instruction causing the exception or the immediately following instruction. The instruction addressed can be determined from the exception type and status bits, which are defined in the description of each exception.
- All instructions that precede the excepting instruction complete before the exception is processed. However, some memory accesses generated by these preceding instructions may not have been performed with respect to all other processors or system devices.
- The instruction causing the exception may not have begun execution, may have partially completed, or may have completed, depending on the exception type. Handling of partially executed instructions is described in Section 6.1.4, “Partially Executed Instructions.”
- Architecturally, no subsequent instruction has begun execution.

While instruction parallelism allows the possibility of multiple instructions reporting exceptions during the same cycle, they are handled one at a time in program order. Exception priorities are described in Section 6.1.5, “Exception Priorities.”

6.1.2.4 Asynchronous Exceptions

There are four asynchronous exceptions—system reset and machine check, which are nonmaskable and highest-priority exceptions, and external interrupt and decremter exceptions which are maskable and low-priority. These two types of asynchronous exceptions are discussed separately.

6.1.2.4.1 System Reset and Machine Check Exceptions

System reset and machine check exceptions have the highest priority and can occur while other exceptions are being processed. Note that nonmaskable, asynchronous exceptions are never delayed; therefore, if two of these exceptions occur in immediate succession, the state information saved by the first exception may be overwritten when the subsequent exception occurs. Note that these exceptions are context-synchronizing if they are recoverable (MSR[RI] is copied from the MSR to SRR1 if the exception does not cause loss of state.) If the RI bit is clear (nonrecoverable), the exception is context-synchronizing only with respect to subsequent instructions.

These exceptions cannot be masked by using the MSR[EE] bit. However, if the machine check enable bit, MSR[ME], is cleared and a machine check exception condition occurs, the processor goes directly into checkstop state as the result of the exception condition. When one of these exceptions occur, the following conditions exist at the exception point:

- For system reset exceptions, SRR0 addresses the instruction that would have attempted to execute next if the exception had not occurred.
- For machine check exceptions, SRR0 holds either an instruction that would have completed or some instruction following it that would have completed if the exception had not occurred.
- An exception is generated such that all instructions preceding the instruction addressed by SRR0 appear to have completed with respect to the executing processor.

Note that a bit in the MSR (MSR[RI]) indicates whether enough of the machine state was saved to allow the processor to resume processing.

6.1.2.4.2 External Interrupt and Decrementer Exceptions

For the external interrupt and decremter exceptions, the following conditions exist at the exception point (assuming these exceptions are enabled (MSR[EE] bit is set)):

- All instructions issued before the exception is taken and any instructions that precede those instructions in the instruction stream appear to have completed before the exception is processed.
- No subsequent instructions in the instruction stream have begun execution.
- SRR0 addresses the instruction that would have been executed had the exception not occurred.

That is, these exceptions are context-synchronizing. The external interrupt and decremented exceptions are maskable. When the machine state register external interrupt enable bit is cleared ($MSR[EE] = 0$), these exception conditions are not recognized until the EE bit is set. MSR[EE] is cleared automatically when an exception is taken, to delay recognition of subsequent exception conditions. No two precise exceptions can be recognized simultaneously. Exception handling does not begin until all currently executing instructions complete and any synchronous, precise exceptions caused by those instructions have been handled. Exception priorities are described in Section 6.1.5, “Exception Priorities.”

6.1.3 Imprecise Exceptions

The PowerPC architecture defines one imprecise exception, the imprecise floating-point enabled exception. This is implemented as one of the conditions that can cause a program exception.

6.1.3.1 Imprecise Exception Status Description

When the execution of an instruction causes an imprecise exception, SRR0 contains information related to the address of the excepting instruction as follows:

- SRR0 contains the address of either the instruction that caused the exception or of some instruction following that instruction.
- The exception is generated such that all instructions preceding the instruction addressed by SRR0 have completed with respect to the processor.
- If the imprecise exception is caused by the context-synchronizing mechanism (due to an instruction that caused another exception—for example, an alignment or DSI exception), then SRR0 contains the address of the instruction that caused the exception, and that instruction may have been partially executed (refer to Section 6.1.4, “Partially Executed Instructions”).
- If the imprecise exception is caused by an execution-synchronizing instruction other than **sync** or **isync**, SRR0 addresses the instruction causing the exception. Additionally, besides causing the exception, that instruction is considered not to have begun execution. If the exception is caused by the **sync** or **isync** instruction, SRR0 may address either the **sync** or **isync** instruction, or the following instruction.
- If the imprecise exception is not forced by either the context-synchronizing mechanism or the execution-synchronizing mechanism, the instruction addressed by SRR0 is considered not to have begun execution if it is not the instruction that caused the exception.
- When an imprecise exception occurs, no instruction following the instruction addressed by SRR0 is considered to have begun execution.

6.1.3.2 Recoverability of Imprecise Floating-Point Exceptions

The enabled IEEE floating-point exception mode bits in the MSR (FE0 and FE1) together define whether IEEE floating-point exceptions are handled precisely, imprecisely, or whether they are taken at all. The possible settings are shown in Table 6-3. For further details, see Section 3.3.6, “Floating-Point Program Exceptions.”

Table 6-3. IEEE Floating-Point Program Exception Mode Bits

FE0	FE1	Mode
0	0	Floating-point exceptions ignored
0	1	Floating-point imprecise nonrecoverable
1	0	Floating-point imprecise recoverable
1	1	Floating-point precise mode

As shown in the table, the imprecise floating-point enabled exception has two modes—nonrecoverable and recoverable. These modes are specified by setting the MSR[FE0] and MSR[FE1] bits and are described as follows:

- Imprecise nonrecoverable floating-point enabled mode. MSR[FE0] = 0; MSR[FE1] = 1. When an exception occurs, the exception handler is invoked at some point at or beyond the instruction that caused the exception. It may not be possible to identify the excepting instruction or the data that caused the exception. Results from the excepting instruction may have been used by or affected subsequent instructions executed before the exception handler was invoked.
- Imprecise recoverable floating-point enabled mode. MSR[FE0] = 1; MSR[FE1] = 0. When an exception occurs, the floating-point enabled exception handler is invoked at some point at or beyond the instruction that caused the exception. Sufficient information is provided to the exception handler that it can identify the excepting instruction and correct any faulty results. In this mode, no incorrect results caused by the excepting instruction have been used by or affected subsequent instructions that are executed before the exception handler is invoked.

Although these exceptions are maskable with these bits, they differ from other maskable exceptions in that the masking is usually controlled by the application program rather than by the operating system.

6.1.4 Partially Executed Instructions

The architecture permits certain instructions to be partially executed when an alignment exception or DSI exception occurs, or an imprecise floating-point exception is forced by an instruction that causes an alignment or DSI exception. They are as follows:

- Load multiple/string instructions that cause an alignment or DSI exception—Some registers in the range of registers to be loaded may have been loaded.
- Store multiple/string instructions that cause an alignment or DSI exception—Some bytes in the addressed memory range may have been updated.
- Non-multiple/string store instructions that cause an alignment or DSI exception—Some bytes just before the boundary may have been updated. If the instruction normally alters CR0 (**stwex.** or **stdcx.**), CR0 is set to an undefined value. For instructions that perform register updates, the update register (**rA**) is not altered.
- Floating-point load instructions that cause an alignment or DSI exception—The target register may be altered. For update forms, the update register (**rA**) is not altered.
- A load or store to a direct-store segment that causes a DSI exception due to a direct-store interface error exception—Some of the associated address/data transfers may not have been initiated. All initiated transfers are completed before the exception is reported, and the transfers that have not been initiated are aborted. Thus the instruction completes before the DSI exception occurs. However, note that the direct-store facility is being phased out of the architecture and will not likely be supported in future devices.

In the cases above, the number of registers and the amount of memory altered are implementation-, instruction-, and boundary-dependent. However, memory protection is not violated. Furthermore, if some of the data accessed is in a direct-store segment and the instruction is not supported for use in such memory space, the locations in the direct-store segment are not accessed. Again, note that the direct-store facility is being phased out of the architecture and will not likely be supported in future devices.

Partial execution is not allowed when integer load operations (except multiple/string operations) cause an alignment or DSI exception. The target register is not altered. For update forms of the integer load instructions, the update register (**rA**) is not altered.

6.1.5 Exception Priorities

Exceptions are roughly prioritized by exception class, as follows:

1. Nonmaskable, asynchronous exceptions have priority over all other exceptions—system reset and machine check exceptions (although the machine check exception condition can be disabled so that the condition causes the processor to go directly into the checkstop state). These two types of exceptions in this class cannot be delayed by exceptions in other classes, and do not wait for the completion of any precise exception handling.
2. Synchronous, precise exceptions are caused by instructions and are taken in strict program order.
3. If an imprecise exception exists (the instruction that caused the exception has been completed and is required by the sequential execution model), exceptions signaled by instructions subsequent to the instruction that caused the exception are not permitted to change the architectural state of the processor. The exception causes an imprecise program exception unless a machine check or system reset exception is pending.
4. Maskable asynchronous exceptions (external interrupt and decremter exceptions) have lowest priority.

The exceptions are listed in Table 6-4 in order of highest to lowest priority.

Table 6-4. Exception Priorities

Exception Class	Priority	Exception
Nonmaskable, asynchronous	1	System reset—The system reset exception has the highest priority of all exceptions. If this exception exists, the exception mechanism ignores all other exceptions and generates a system reset exception. When the system reset exception is generated, previously issued instructions can no longer generate exception conditions that cause a nonmaskable exception.
	2	Machine check—The machine check exception is the second-highest priority exception. If this exception occurs, the exception mechanism ignores all other exceptions (except reset) and generates a machine check exception. When the machine check exception is generated, previously issued instructions can no longer generate exception conditions that cause a nonmaskable exception.

Table 6-4. Exception Priorities (Continued)

Exception Class	Priority	Exception
Synchronous, precise	3	<p>Instruction dependent— When an instruction causes an exception, the exception mechanism waits for any instructions prior to the excepting instruction in the instruction stream to complete. Any exceptions caused by these instructions are handled first. It then generates the appropriate exception if no higher priority exception exists when the exception is to be generated.</p> <p>Note that a single instruction can cause multiple exceptions. When this occurs, those exceptions are ordered in priority as indicated in the following:</p> <p>A. Integer loads and stores</p> <ul style="list-style-type: none"> a. Alignment b. DSI c. Trace (if implemented) <p>B. Floating-point loads and stores</p> <ul style="list-style-type: none"> a. Floating-point unavailable b. Alignment c. DSI d. Trace (if implemented) <p>C. Other floating-point instructions</p> <ul style="list-style-type: none"> a. Floating-point unavailable b. Program—Precise-mode floating-point enabled exception c. Floating-point assist (if implemented) d. Trace (if implemented) <p>D. rfid (or rfi) and mtmsrd (or mtmsr)</p> <ul style="list-style-type: none"> a. Program—Privileged Instruction b. Program—Precise-mode floating-point enabled exception c. Trace (if implemented), for mtmsrd (or mtmsr) only <p>If precise-mode IEEE floating-point enabled exceptions are enabled and the FPSCR[FEX] bit is set, a program exception occurs no later than the next synchronizing event.</p> <p>E. Other instructions</p> <ul style="list-style-type: none"> a. These exceptions are mutually exclusive and have the same priority: <ul style="list-style-type: none"> —Program: Trap — System call (sc) —Program: Privileged Instruction —Program: Illegal Instruction b. Trace (if implemented) <p>F. ISI exception</p> <p>The ISI exception has the lowest priority in this category. It is only recognized when all instructions prior to the instruction causing this exception appear to have completed and that instruction is to be executed. The priority of this exception is specified for completeness and to ensure that it is not given more favorable treatment. An implementation can treat this exception as though it had a lower priority.</p>
Imprecise	4	<p>Program imprecise floating-point mode enabled exceptions—When this exception occurs, the exception handler is invoked at or beyond the floating-point instruction that caused the exception. The PowerPC architecture supports recoverable and nonrecoverable imprecise modes, which are enabled by setting MSR[FE0] ≠ MSR[FE1]. For more information see, Section 6.1.3, "Imprecise Exceptions."</p>

Table 6-4. Exception Priorities (Continued)

Exception Class	Priority	Exception
Maskable, asynchronous	5	External interrupt—The external interrupt mechanism waits for instructions currently or previously dispatched to complete execution. After all such instructions are completed, and any exceptions caused by those instructions have been handled, the exception mechanism generates this exception if no higher priority exception exists. This exception is enabled only if MSR[EE] is currently set. If EE is zero when the exception is detected, it is delayed until the bit is set.
	6	Decrementer—This exception is the lowest priority exception. When this exception is created, the exception mechanism waits for all other possible exceptions to be reported. It then generates this exception if no higher priority exception exists. This exception is enabled only if MSR[EE] is currently set. If EE is zero when the exception is detected, it is delayed until the bit is set.

Nonmaskable, asynchronous exceptions (namely, system reset or machine check exceptions) may occur at any time. That is, these exceptions are not delayed if another exception is being handled (although machine check exceptions can be delayed by system reset exceptions). As a result, state information for the interrupted exception handler may be lost.

All other exceptions have lower priority than system reset and machine check exceptions, and the exception may not be taken immediately when it is recognized. Only one synchronous, precise exception can be reported at a time. If a maskable, asynchronous or an imprecise exception condition occurs while instruction-caused exceptions are being processed, its handling is delayed until all exceptions caused by previous instructions in the program flow are handled and those instructions complete execution.

6.2 Exception Processing

When an exception is taken, the processor uses the save/restore registers, SRR1 and SRR0, respectively, to save the contents of the MSR for the interrupted process and to help determine where instruction execution should resume after the exception is handled.

When an exception occurs, the address saved in SRR0 is used to help calculate where instruction processing should resume when the exception handler returns control to the interrupted process. Depending on the exception, this may be the address in SRR0 or at the next address in the program flow. All instructions in the program flow preceding this one will have completed execution and no subsequent instruction will have begun execution. This may be the address of the instruction that caused the exception or the next one (as in the case of a system call or trap exception). The SRR0 register is shown in Figure 6-1.

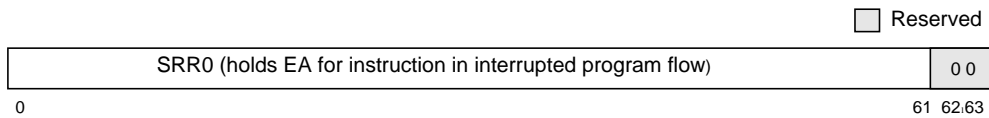

Figure 6-1. Machine Status Save/Restore Register 0

This register is 32 bits wide in 32-bit implementations.

The save/restore register 1 (SRR1) is used to save machine status (selected bits from the MSR and other implementation-specific status bits as well) on exceptions and to restore those values when **rfid** (or **rfi**) is executed. SRR1 is shown in Figure 6-2.

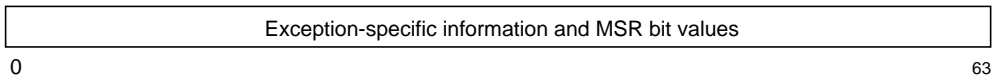

Figure 6-2. Machine Status Save/Restore Register 1

This register is 32 bits wide in 32-bit implementations. When an exception occurs, SRR1 bits 33–36 and 42–47 (bits 1–4 and 10–15 in 32-bit implementations) are loaded with exception-specific information and MSR bits 0, 48–55, 57–59 and 62–63 (bits 16–23, 25–27, and 30–31 in 32-bit implementations) are placed into the corresponding bit positions of SRR1. Depending on the implementation, additional bits of the MSR may be copied to SRR1.

Note that, in some implementations, every instruction fetch when MSR[IR] = 1, and every data access requiring address translation when MSR[DR] = 1, may modify SRR0 and SRR1.

The MSR bits for 64-bit implementations are shown in Figure 6-3.

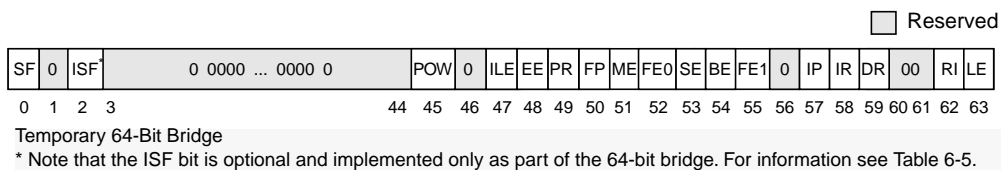

Figure 6-3. Machine State Register (MSR)—64-Bit Implementation

In 32-bit PowerPC implementations, the MSR is 32 bits wide as shown in Figure 6-4. Note that the 32-bit implementation of the MSR is comprised of the 32 least-significant bits of the 64-bit MSR.

Table 6-5. MSR Bit Settings (Continued)

Bit(s)		Name	Description
64 Bit	32 Bit		
52	20	FE0	Floating-point exception mode 0 (see Table 2-10 on page 23).
53	21	SE	Single-step trace enable (optional) 0 The processor executes instructions normally. 1 The processor generates a single-step trace exception upon the successful execution of the next instruction. Note: If the function is not implemented, this bit is treated as reserved.
54	22	BE	Branch trace enable (optional) 0 The processor executes branch instructions normally. 1 The processor generates a branch trace exception after completing the execution of a branch instruction, regardless of whether the branch was taken. Note: If the function is not implemented, this bit is treated as reserved.
55	23	FE1	Floating-point exception mode 1 (see Table 2-10 on page 23).
56	24	—	Reserved
57	25	IP	Exception prefix. The setting of this bit specifies whether an exception vector offset is prepended with Fs or 0s. In the following description, <i>nnnn</i> is the offset of the exception vector. See Table 6-2. 0 Exceptions are vectored to the physical address 0x000n_nnnn in 32-bit implementations and 0x0000_0000_000n_nnnn in 64-bit implementations. 1 Exceptions are vectored to the physical address 0xFFFFn_nnnn in 32-bit implementations and 0x0000_0000_FFFn_nnnn in 64-bit implementations. In most systems, IP is set to 1 during system initialization, and then cleared to 0 when initialization is complete.
58	26	IR	Instruction address translation 0 Instruction address translation is disabled. 1 Instruction address translation is enabled. For more information see Chapter 7, "Memory Management."
59	27	DR	Data address translation 0 Data address translation is disabled. 1 Data address translation is enabled. For more information see Chapter 7, "Memory Management."
60–61	28–29	—	Reserved
62	30	RI	Recoverable exception (for system reset and machine check exceptions). 0 Exception is not recoverable. 1 Exception is recoverable. For more information see Section 6.4.1, "System Reset Exception (0x00100)," and Section 6.4.2, "Machine Check Exception (0x00200)."
63	31	LE	Little-endian mode enable 0 The processor runs in big-endian mode. 1 The processor runs in little-endian mode.

TEMPORARY 64-BIT BRIDGE

Bit 2 of the MSR (MSR[ISF]) may optionally be used by a 64-bit implementation to control the mode (64-bit or 32-bit) that is entered when an exception is taken. If this bit is implemented, it has the following properties:

- When an exception is taken, the value of MSR[ISF] is copied to MSR[SF].
- When an exception is taken, MSR[ISF] is not altered.
- No software synchronization is required before or after altering MSR[ISF]. Refer to Section 2.3.18, “Synchronization Requirements for Special Registers and for Lookaside Buffers,” for more information on synchronization requirements for altering other bits in the MSR.

If the MSR[ISF] bit is not implemented, it is treated as reserved except that the value is assumed to be 1 for exception processing.

Those MSR bits that are written to SRR1 are written when the first instruction of the exception handler is encountered. The data address register (DAR) is used by several exceptions (for example, DSI and alignment exceptions) to identify the address of a memory element.

6.2.1 Enabling and Disabling Exceptions

When a condition exists that may cause an exception to be generated, it must be determined whether the exception is enabled for that condition as follows:

- IEEE floating-point enabled exceptions (a type of program exception) are ignored when both MSR[FE0] and MSR[FE1] are cleared. If either of these bits is set, all IEEE enabled floating-point exceptions are taken and cause a program exception.
- Asynchronous, maskable exceptions (that is, the external and decremter interrupts) are enabled by setting the MSR[EE] bit. When MSR[EE] = 0, recognition of these exception conditions is delayed. MSR[EE] is cleared automatically when an exception is taken, to delay recognition of conditions causing those exceptions.
- A machine check exception can only occur if the machine check enable bit, MSR[ME], is set. If MSR[ME] is cleared, the processor goes directly into checkstop state when a machine check exception condition occurs.

6.2.2 Steps for Exception Processing

After it is determined that the exception can be taken (by confirming that any instruction-caused exceptions occurring earlier in the instruction stream have been handled, and by confirming that the exception is enabled for the exception condition), the processor does the following:

1. The machine status save/restore register 0 (SRR0) is loaded with an instruction address that depends on the type of exception. See the individual exception description for details about how this register is used for specific exceptions.
2. SRR1 bits 33–36 and 42–47 (bits 1–4 and 10–15 in 32-bit implementations) are loaded with information specific to the exception type.
3. MSR bits 0, 48–55, 57–59 and 62–63 (bits 16–23, 25–27, and 30–31 in 32-bit implementations) are loaded with a copy of the corresponding bits of the MSR. Note that depending on the implementation, additional bits from the MSR may be saved in SRR1.
4. The MSR is set as described in Table 6-6. The new values take effect beginning with the fetching of the first instruction of the exception-handler routine located at the exception vector address.

Note that MSR[IR] and MSR[DR] are cleared for all exception types; therefore, address translation is disabled for both instruction fetches and data accesses beginning with the first instruction of the exception-handler routine.

Also, note that the MSR[ILE] bit setting at the time of the exception is copied to MSR[LE] when the exception is taken (as shown in Table 6-6).

TEMPORARY 64-BIT BRIDGE

Similar to MSR[ILE], the MSR[ISF] bit setting at the time of the exception is copied to MSR[SF] when the exception is taken (if the ISF bit is implemented).

5. Instruction fetch and execution resumes, using the new MSR value, at a location specific to the exception type. The location is determined by adding the exception's vector offset (see Table 6-2) to the base address determined by MSR[IP]. If IP is cleared, exceptions are vectored to the physical address 0x0000_0000_000n_nnnn in 64-bit implementations and 0x000n_nnnn in 32-bit implementations. If IP is set, exceptions are vectored to the physical address 0x0000_0000_FFFn_nnnn in 64-bit implementations and 0xFFFFn_nnnn in 32-bit implementations. For a machine check exception that occurs when MSR[ME] = 0 (machine check exceptions are disabled), the checkstop state is entered (the machine stops executing instructions). See Section 6.4.2, “Machine Check Exception (0x00200).”

In some implementations, any instruction fetch with MSR[IR] = 1 and any load or store with MSR[DR] = 1 may cause SRR0 and SRR1 to be modified.

6.2.3 Returning from an Exception Handler

The Return from Interrupt (**rfd** [or **rfi**]) instruction performs context synchronization by allowing previously issued instructions to complete before returning to the interrupted process. Execution of the **rfd** (or **rfi**) instruction ensures the following:

- All previous instructions have completed to a point where they can no longer cause an exception.
If a previous instruction causes a direct-store interface error exception, the results are determined before this instruction is executed. However, note that the direct-store facility is being phased out of the architecture and will not likely be supported in future devices.
- Previous instructions complete execution in the context (privilege, protection, and address translation) under which they were issued.
- The **rfd** (or **rfi**) instruction copies SRR1 bits back into the MSR.
- The instructions following this instruction execute in the context established by this instruction.

For a complete description of context synchronization, refer to Section 6.1.2.1, “Context Synchronization.”

TEMPORARY 64-BIT BRIDGE

The 64-bit bridge facility affects the operation of the return from exception mechanism in that the **rfi** instruction can optionally be allowed to execute in 64-bit implementations. In this case, the **mtmsr** instruction must also be implemented. When these instructions are implemented on a 64-bit implementation, their operation is identical to their operation in a 32-bit implementation. For an **rfi** instruction, in addition to the actions described above, the following occurs:

- The SRR1 bits that are copied to the corresponding bits of the MSR are bits 48–55, 57–59 and 62–63 of SRR1. Note that depending on the implementation, additional bits from SRR1 may be restored to the MSR. The remaining bits of the MSR, including the high-order 32 bits are unchanged.
- If the new MSR value does not enable any pending exceptions, then the next instruction is fetched, under control of the new MSR value from the address specified in SRR0[0–61] concatenated with 0b00 (when MSR[SF] = 1 in the new MSR value). Alternately, when MSR[SF] = 0 in the new MSR value, the next instruction is fetched from the address specified by thirty-two 0’s concatenated with SRR0[32–61], concatenated with 0b00.

6.3 Process Switching

The operating system should execute the following when processes are switched:

- The **sync** instruction, which orders the effects of instruction execution. All instructions previously initiated appear to have completed before the **sync** instruction completes, and no subsequent instructions appear to be initiated until the **sync** instruction completes.
- The **isync** instruction, which waits for all previous instructions to complete and then discards any fetched instructions, causing subsequent instructions to be fetched (or refetched) from memory and to execute in the context (privilege, translation, protection, etc.) established by the previous instructions.
- The **stwcx./stdcx.** instruction, to clear any outstanding reservations, which ensures that an **lwarx/ldarx** instruction in the old process is not paired with an **stwcx./stdcx.** instruction in the new process.

The operating system should handle MSR[RI] as follows:

- In machine check and system reset exception handlers—If the SRR1 bit corresponding to MSR[RI] is cleared, the exception is not recoverable.
- In each exception handler—When enough state information has been saved that a machine check or system reset exception can reconstruct the previous state, set MSR[RI].
- At the end of each exception handler—Clear MSR[RI], set the SRR0 and SRR1 registers appropriately, and then execute **rfid** (or **rfi**).

Note that the RI bit being set indicates that, with respect to the processor, enough processor state data is valid for the processor to continue, but it does not guarantee that the interrupted process can resume.

6.4 Exception Definitions

Table 6-6 shows all the types of exceptions that can occur and certain MSR bit settings when the exception handler is invoked. Depending on the exception, certain of these bits are stored in SRR1 when an exception is taken. The following subsections describe each exception in detail.

Table 6-6. MSR Setting Due to Exception

Exception Type	MSR Bit																
	SF ^{1,2}	ISF ²	POW	ILE	EE	PR	FP	ME	FE0	SE	BE	FE1	IP	IR	DR	RI	LE
System reset	1	—	0	—	0	0	0	—	0	0	0	0	—	0	0	0	ILE
Machine check	1	—	0	—	0	0	0	0	0	0	0	0	—	0	0	0	ILE
DSI	1	—	0	—	0	0	0	—	0	0	0	0	—	0	0	0	ILE
ISI	1	—	0	—	0	0	0	—	0	0	0	0	—	0	0	0	ILE
External	1	—	0	—	0	0	0	—	0	0	0	0	—	0	0	0	ILE
Alignment	1	—	0	—	0	0	0	—	0	0	0	0	—	0	0	0	ILE
Program	1	—	0	—	0	0	0	—	0	0	0	0	—	0	0	0	ILE
Floating-point unavailable	1	—	0	—	0	0	0	—	0	0	0	0	—	0	0	0	ILE
Decrementer	1	—	0	—	0	0	0	—	0	0	0	0	—	0	0	0	ILE
System call	1	—	0	—	0	0	0	—	0	0	0	0	—	0	0	0	ILE
Trace exception	1	—	0	—	0	0	0	—	0	0	0	0	—	0	0	0	ILE
Floating-point assist exception	1	—	0	—	0	0	0	—	0	0	0	0	—	0	0	0	ILE

0 Bit is cleared.
1 Bit is set.
ILE Bit is copied from the ILE bit in the MSR.
— Bit is not altered.
Reading of reserved bits may return 0, even if the value last written to it was 1.

¹64-bit implementations only.

TEMPORARY 64-BIT BRIDGE

²When the 64-bit bridge is implemented in a 64-bit processor and the MSR[ISF] bit is implemented, the value of the MSR[ISF] bit is copied to the MSR[SF] bit when an exception is taken.

6.4.1 System Reset Exception (0x00100)

The system reset exception is a nonmaskable, asynchronous exception signaled to the processor typically through the assertion of a system-defined signal; see Table 6-7.

Table 6-7. System Reset Exception—Register Settings

Register	Setting Description			
SRR0	Set to the effective address of the instruction that the processor would have attempted to execute next if no exception conditions were present.			
SRR1	64-Bit	32-Bit		
	0	—	Loaded with equivalent bit from the MSR	
	33–36	1–4	Cleared	
	42–47	10–15	Cleared	
	48–55	16–23	Loaded with equivalent bits from the MSR	
	57–59	25–27	Loaded with equivalent bits from the MSR	
	62	30	Loaded from the equivalent MSR bit, MSR[RI], if the exception is recoverable; otherwise cleared.	
	63	31	Loaded with equivalent bit from the MSR	
Note that depending on the implementation, additional bits in the MSR may be copied to SRR1. If the processor state is corrupted to the extent that execution cannot resume reliably, the bit corresponding to MSR[RI], (SRR1[62] in 64-bit implementations and SRR1[30] in 32-bit implementations), is cleared.				
MSR	SF [*] 1	PR 0	SE 0	IR 0
	ISF [*] —	FP 0	BE 0	DR 0
	POW 0	ME —	FE1 0	RI 0
	ILE —	FE0 0	IP —	LE Set to value of ILE
	EE 0			
TEMPORARY 64-BIT BRIDGE				
* ² If the MSR[ISF] bit is implemented, the value of the MSR[ISF] bit is copied to the MSR[SF] bit when an exception is taken.				

When a system reset exception is taken, instruction execution continues at offset 0x00100 from the physical base address determined by MSR[IP].

If the exception is recoverable, the value of the MSR[RI] bit is copied to the corresponding SRR1 bit. The exception functions as a context-synchronizing operation. If a reset exception causes the loss of:

- an external exception (interrupt or decremter),
- direct-store error type DSI (the direct-store facility is being phased out of the architecture—not likely to be supported in future devices), or
- floating-point enabled type program exception,

then the exception is not recoverable. If the SRR1 bit corresponding to MSR[RI] is cleared, the exception is context-synchronizing only with respect to subsequent instructions. Note that each implementation provides a means for software to distinguish between power-on reset and other types of system resets (such as soft reset).

6.4.2 Machine Check Exception (0x00200)

If no higher-priority exception is pending (namely, a system reset exception), the processor initiates a machine check exception when the appropriate condition is detected. Note that the causes of machine check exceptions are implementation- and system-dependent, and are typically signalled to the processor by the assertion of a specified signal on the processor interface.

When a machine check condition occurs and $MSR[ME] = 1$, the exception is recognized and handled. If $MSR[ME] = 0$ and a machine check occurs, the processor generates an internal checkstop condition. When a processor is in checkstop state, instruction processing is suspended and generally cannot continue without resetting the processor. Some implementations may preserve some or all of the internal state of the processor when entering the checkstop state, so that the state can be analyzed as an aid in problem determination.

In general, it is expected that a bus error signal would be used by a memory controller to indicate a memory parity error or an uncorrectable memory ECC error. Note that the resulting machine check exception has priority over any exceptions caused by the instruction that generated the bus operation.

If a machine check exception causes an exception that is not context-synchronizing, the exception is not recoverable. Also, a machine check exception is not recoverable if it causes the loss of one of the following:

- An external exception (interrupt or decremter)
- Direct-store error type DSI (the direct-store facility is being phased out of the architecture and is not likely to be supported in future devices)
- Floating-point enabled type program exception

If the $SRR1$ bit corresponding to $MSR[RI]$ is cleared, the exception is context-synchronizing only with respect to subsequent instructions. If the exception is recoverable, the $SRR1$ bit corresponding to $MSR[RI]$ is set and the exception is context-synchronizing.

Note that if the error is caused by the memory subsystem, incorrect data could be loaded into the processor and register contents could be corrupted regardless of whether the exception is considered recoverable by the $SRR1$ bit corresponding to $MSR[RI]$.

On some implementations, a machine check exception may be caused by referring to a nonexistent physical (real) address, either because translation is disabled ($MSR[IR] = 0$) or through an invalid translation. On such a system, execution of the **dcbz** or **dcba** instruction can cause a delayed machine check exception by introducing a block into the data cache that is associated with an invalid physical (real) address. A machine check exception could eventually occur when and if a subsequent attempt is made to store that block to memory (for example, as the block becomes the target for replacement, or as the result of executing a **dcbst** instruction).

When a machine check exception is taken, registers are updated as shown in Table 6-8.

Table 6-8. Machine Check Exception—Register Settings

Register	Setting Description																																								
SRR0	On a best-effort basis, implementations can set this to an EA of some instruction that was executing or about to be executing when the machine check condition occurred.																																								
SRR1	Bit 62 (bit 30 in 32-bit implementations) is loaded from MSR[R] if the processor is in a recoverable state. Otherwise cleared. The setting of all other SRR1 bits is implementation-dependent.																																								
MSR	<table> <tr> <td>SF¹</td> <td>1</td> <td>PR</td> <td>0</td> <td>SE</td> <td>0</td> <td>IR</td> <td>0</td> </tr> <tr> <td>ISF¹</td> <td>—</td> <td>FP</td> <td>0</td> <td>BE</td> <td>0</td> <td>DR</td> <td>0</td> </tr> <tr> <td>POW</td> <td>0</td> <td>ME²</td> <td>—</td> <td>FE1</td> <td>0</td> <td>RI</td> <td>0</td> </tr> <tr> <td>ILE</td> <td>—</td> <td>FE0</td> <td>0</td> <td>IP</td> <td>—</td> <td>LE</td> <td>Set to value of ILE</td> </tr> <tr> <td>EE</td> <td>0</td> <td></td> <td></td> <td></td> <td></td> <td></td> <td></td> </tr> </table>	SF ¹	1	PR	0	SE	0	IR	0	ISF ¹	—	FP	0	BE	0	DR	0	POW	0	ME ²	—	FE1	0	RI	0	ILE	—	FE0	0	IP	—	LE	Set to value of ILE	EE	0						
SF ¹	1	PR	0	SE	0	IR	0																																		
ISF ¹	—	FP	0	BE	0	DR	0																																		
POW	0	ME ²	—	FE1	0	RI	0																																		
ILE	—	FE0	0	IP	—	LE	Set to value of ILE																																		
EE	0																																								
TEMPORARY 64-BIT BRIDGE																																									
¹ If the MSR[ISF] bit is implemented, the value of the MSR[ISF] bit is copied to the MSR[SF] bit when an exception is taken																																									
² Note that when a machine check exception is taken, the exception handler should set MSR[ME] as soon as it is practical to handle another machine check exception. Otherwise, subsequent machine check exceptions cause the processor to automatically enter the checkstop state.																																									

If MSR[RI] is set, the machine check exception may still be unrecoverable in the sense that execution cannot resume in the same context that existed before the exception.

When a machine check exception is taken, instruction execution resumes at offset 0x00200 from the physical base address determined by MSR[IP].

6.4.3 DSI Exception (0x00300)

A DSI exception occurs when no higher priority exception exists and a data memory access cannot be performed. The condition that caused the DSI exception can be determined by reading the DSISR, a supervisor-level SPR (SPR18) that can be read by using the **mfspr** instruction. Bit settings are provided in Table 6-9. Table 6-9 also indicates which memory element is pointed to by the DAR. DSI exceptions can be generated by load/store instructions, cache-control instructions (**icbi**, **dcbi**, **dcbz**, **dcbst**, and **dcbf**), or the **eciwx/ecowx** instructions for any of the following reasons:

- A load or a store instruction results in a direct-store error exception. Note that the direct-store facility is being phased out of the architecture and is not likely to be supported in future devices.
- The effective address cannot be translated. That is, there is a page fault for this portion of the translation, so a DSI exception must be taken to retrieve the translation, for example from a storage device such as a hard disk drive.

- The instruction is not supported for the type of memory addressed.
 - For **lwarx/stwrx.** and **ldarx/stdcx.** instructions that reference a memory location that is write-through required. If the exception is not taken, the instructions execute correctly.
 - For **lwarx/stwrx., ldarx/stdcx.,** or **eciwx/ecowx** instructions that attempt to access direct-store segments (direct-store facility is being phased out of the architecture—not likely to be supported in future devices). If the exception does not occur, the results are boundedly undefined.
- The access violates memory protection.
- The execution of an **eciwx** or **ecowx** instruction is disallowed because the external access register enable bit (EAR[E]) is cleared.
- A data address breakpoint register (DABR) match occurs. The DABR facility is optional to the PowerPC architecture, but if one is implemented, it is recommended, but not required, that it be implemented as follows. A data address breakpoint match is detected for a load or store instruction if the three following conditions are met for any byte accessed:
 - EA[0–60] (EA[0–28] in 32-bit implementations) = DABR[DAB]
 - MSR[DR] = DABR[BT]
 - The instruction is a store and DABR[DW] = 1, or the instruction is a load and DABR[DR] = 1.

The DABR is described in Section 2.3.15, “Data Address Breakpoint Register (DABR).” In 32-bit mode of 64-bit implementations, the high-order 32 bits of the EA are treated as zero for the purpose of detecting a match; the DAR settings are described in Table 6-9. If the above conditions are satisfied, it is undefined whether a match occurs in the following cases:

- The instruction is store conditional but the store is not performed.
- The instruction is a load/store string of zero length.
- The instruction is **dcbz**, **eciwx**, or **ecowx**.

The cache management instructions other than **dcbz** never cause a match. If **dcbz** causes a match, some or all of the target memory locations may have been updated. For the purpose of determining whether a match occurs, **eciwx** is treated as a load, and **ecowx** and **dcbz** are treated as stores.

If an **stwrx./stdcx.** instruction has an EA for which a normal store operation would cause a DSI exception but the processor does not have the reservation from **lwarx/ldarx**, whether a DSI exception is taken is implementation-dependent.

If the value in XER[25–31] indicates that a load or store string instruction has a length of zero, a DSI exception does not occur, regardless of the effective address.

The condition that caused the exception is defined in the DSISR. As shown in Table 6-9, this exception also sets the data address register (DAR).

Table 6-9. DSI Exception—Register Settings

Register	Setting Description																																								
SRR0	Set to the effective address of the instruction that caused the exception.																																								
SRR1	<table border="0"> <thead> <tr> <th>64-Bit</th> <th>32-Bit</th> <th></th> </tr> </thead> <tbody> <tr> <td>0</td> <td>—</td> <td>Loaded with equivalent bit from the MSR</td> </tr> <tr> <td>33–36</td> <td>1–4</td> <td>Cleared</td> </tr> <tr> <td>42–47</td> <td>10–15</td> <td>Cleared</td> </tr> <tr> <td>48–55</td> <td>16–23</td> <td>Loaded with equivalent bits from the MSR</td> </tr> <tr> <td>57–59</td> <td>25–27</td> <td>Loaded with equivalent bits from the MSR</td> </tr> <tr> <td>62–63</td> <td>30–31</td> <td>Loaded with equivalent bits from the MSR</td> </tr> </tbody> </table> <p>Note that depending on the implementation, additional bits in the MSR may be copied to SRR1.</p>	64-Bit	32-Bit		0	—	Loaded with equivalent bit from the MSR	33–36	1–4	Cleared	42–47	10–15	Cleared	48–55	16–23	Loaded with equivalent bits from the MSR	57–59	25–27	Loaded with equivalent bits from the MSR	62–63	30–31	Loaded with equivalent bits from the MSR																			
64-Bit	32-Bit																																								
0	—	Loaded with equivalent bit from the MSR																																							
33–36	1–4	Cleared																																							
42–47	10–15	Cleared																																							
48–55	16–23	Loaded with equivalent bits from the MSR																																							
57–59	25–27	Loaded with equivalent bits from the MSR																																							
62–63	30–31	Loaded with equivalent bits from the MSR																																							
MSR	<table border="0"> <tbody> <tr> <td>SF *</td> <td>1</td> <td>PR</td> <td>0</td> <td>SE</td> <td>0</td> <td>IR</td> <td>0</td> </tr> <tr> <td>ISF *</td> <td>—</td> <td>FP</td> <td>0</td> <td>BE</td> <td>0</td> <td>DR</td> <td>0</td> </tr> <tr> <td>POW</td> <td>0</td> <td>ME</td> <td>—</td> <td>FE1</td> <td>0</td> <td>RI</td> <td>0</td> </tr> <tr> <td>ILE</td> <td>—</td> <td>FE0</td> <td>0</td> <td>IP</td> <td>—</td> <td>LE</td> <td>Set to value of ILE</td> </tr> <tr> <td>EE</td> <td>0</td> <td></td> <td></td> <td></td> <td></td> <td></td> <td></td> </tr> </tbody> </table>	SF *	1	PR	0	SE	0	IR	0	ISF *	—	FP	0	BE	0	DR	0	POW	0	ME	—	FE1	0	RI	0	ILE	—	FE0	0	IP	—	LE	Set to value of ILE	EE	0						
SF *	1	PR	0	SE	0	IR	0																																		
ISF *	—	FP	0	BE	0	DR	0																																		
POW	0	ME	—	FE1	0	RI	0																																		
ILE	—	FE0	0	IP	—	LE	Set to value of ILE																																		
EE	0																																								
<p>TEMPORARY 64-BIT BRIDGE</p> <p>* If the MSR[ISF] bit is implemented, the value of the MSR[ISF] bit is copied to the MSR[SF] bit when an exception is taken.</p>																																									
DSISR	<table border="0"> <tbody> <tr> <td>0</td> <td>Set if a load or store instruction results in a direct-store error exception; otherwise cleared. Note that the direct-store facility is being phased out of the architecture and is not likely to be supported in future devices.</td> </tr> <tr> <td>1</td> <td>Set if the translation of an attempted access is not found in the primary hash table entry group (HTEG), or in the rehashed secondary HTEG, or in the range of a DBAT register (page fault condition); otherwise cleared.</td> </tr> <tr> <td>2–3</td> <td>Cleared</td> </tr> <tr> <td>4</td> <td>Set if a memory access is not permitted by the page or DBAT protection mechanism; otherwise cleared.</td> </tr> <tr> <td>5</td> <td>Set if the eciw_x, ecow_x, lwar_x/ldar_x, or stwc_x/stdc_x instruction is attempted to direct-store interface space, or if the lwar_x/ldar_x or stwc_x/stdc_x instruction is used with addresses that are marked as write-through. Otherwise cleared to 0. Note that the direct-store facility is being phased out of the architecture and is not likely to be supported in future devices.</td> </tr> <tr> <td>6</td> <td>Set for a store operation and cleared for a load operation.</td> </tr> <tr> <td>7–8</td> <td>Cleared</td> </tr> <tr> <td>9</td> <td>Set if a DABR match occurs. Otherwise cleared.</td> </tr> <tr> <td>10</td> <td>For 64-bit implementations, set if the segment table search fails to find a translation for the effective address (segment fault condition); otherwise cleared. Cleared in 32-bit implementations.</td> </tr> <tr> <td>11</td> <td>Set if the instruction is an eciw_x or ecow_x and EAR[E] = 0; otherwise cleared.</td> </tr> <tr> <td>12–31</td> <td>Cleared</td> </tr> </tbody> </table> <p>Due to the multiple exception conditions possible from the execution of a single instruction, the following combinations of bits of DSISR may be set concurrently:</p> <ul style="list-style-type: none"> • Bits 1 and 11 • Bits 4 and 5 • Bits 4 and 11 • Bits 5 and 11 • Bits 10 and 11 <p>Additionally, bit 6 is set if the instruction that caused the exception is a store, ecow_x, dcbz, dcb_a, or dcbi and bit 6 would otherwise be cleared. Also, bit 9 (DABR match) may be set alone, or in combination with any other bit, or with any of the other combinations shown above.</p>	0	Set if a load or store instruction results in a direct-store error exception; otherwise cleared. Note that the direct-store facility is being phased out of the architecture and is not likely to be supported in future devices.	1	Set if the translation of an attempted access is not found in the primary hash table entry group (HTEG), or in the rehashed secondary HTEG, or in the range of a DBAT register (page fault condition); otherwise cleared.	2–3	Cleared	4	Set if a memory access is not permitted by the page or DBAT protection mechanism; otherwise cleared.	5	Set if the eciw_x , ecow_x , lwar_x/ldar_x , or stwc_x/stdc_x instruction is attempted to direct-store interface space, or if the lwar_x/ldar_x or stwc_x/stdc_x instruction is used with addresses that are marked as write-through. Otherwise cleared to 0. Note that the direct-store facility is being phased out of the architecture and is not likely to be supported in future devices.	6	Set for a store operation and cleared for a load operation.	7–8	Cleared	9	Set if a DABR match occurs. Otherwise cleared.	10	For 64-bit implementations, set if the segment table search fails to find a translation for the effective address (segment fault condition); otherwise cleared. Cleared in 32-bit implementations.	11	Set if the instruction is an eciw_x or ecow_x and EAR[E] = 0; otherwise cleared.	12–31	Cleared																		
0	Set if a load or store instruction results in a direct-store error exception; otherwise cleared. Note that the direct-store facility is being phased out of the architecture and is not likely to be supported in future devices.																																								
1	Set if the translation of an attempted access is not found in the primary hash table entry group (HTEG), or in the rehashed secondary HTEG, or in the range of a DBAT register (page fault condition); otherwise cleared.																																								
2–3	Cleared																																								
4	Set if a memory access is not permitted by the page or DBAT protection mechanism; otherwise cleared.																																								
5	Set if the eciw_x , ecow_x , lwar_x/ldar_x , or stwc_x/stdc_x instruction is attempted to direct-store interface space, or if the lwar_x/ldar_x or stwc_x/stdc_x instruction is used with addresses that are marked as write-through. Otherwise cleared to 0. Note that the direct-store facility is being phased out of the architecture and is not likely to be supported in future devices.																																								
6	Set for a store operation and cleared for a load operation.																																								
7–8	Cleared																																								
9	Set if a DABR match occurs. Otherwise cleared.																																								
10	For 64-bit implementations, set if the segment table search fails to find a translation for the effective address (segment fault condition); otherwise cleared. Cleared in 32-bit implementations.																																								
11	Set if the instruction is an eciw_x or ecow_x and EAR[E] = 0; otherwise cleared.																																								
12–31	Cleared																																								

Table 6-9. DSI Exception—Register Settings (Continued)

Register	Setting Description
DAR	<p>Set to the effective address of a memory element as described in the following list:</p> <ul style="list-style-type: none"> • A byte in the first word accessed in the segment or BAT area that caused the DSI exception, for a byte, half word, or word memory access (to a segment or BAT area). • A byte in the first double word accessed in the segment or BAT area that caused the DSI exception, for a double-word memory access (to a segment or BAT area). • A byte in the block that caused the exception for a cache management instruction. • Any EA in the memory range addressed (for direct-store error exceptions). Note that the direct-store facility is being phased out of the architecture and is not likely to be supported in future devices. • The EA computed by the instruction for the attempted execution of an eciw_x or ecow_x instruction when EAR[E] is cleared. • If the exception is caused by a DABR match, the DAR is set to the effective address of any byte in the range from A to B inclusive, where A is the effective address of the word (for a byte, half word, or word access) or double word (for a double word access) specified by the EA computed by the instruction, and B is the EA of the last byte in the word or double word in which the match occurred. <p>Note that if the exception occurs when a 64-bit processor is running in 32-bit mode, the 32 high-order bits are cleared.</p>

When a DSI exception is taken, instruction execution resumes at offset 0x00300 from the physical base address determined by MSR[IP].

6.4.4 ISI Exception (0x00400)

An ISI exception occurs when no higher priority exception exists and an attempt to fetch the next instruction to be executed fails for any of the following reasons:

- The effective address cannot be translated. For example, when there is a page fault for this portion of the translation, an ISI exception must be taken to retrieve the page (and possibly the translation), typically from a storage device.
- An attempt is made to fetch an instruction from a no-execute segment.
- An attempt is made to fetch an instruction from guarded memory and MSR[IR] = 1.
- The fetch access violates memory protection.
- An attempt is made to fetch an instruction from a direct-store segment. Note that the direct-store facility is being phased out of the architecture and is not likely to be supported in future devices.

Register settings for ISI exceptions are shown in Table 6-10.

Table 6-10. ISI Exception—Register Settings

Register	Setting Description							
SRR0	Set to the effective address of the instruction that the processor would have attempted to execute next if no exception conditions were present (if the exception occurs on attempting to fetch a branch target, SRR0 is set to the branch target address).							
SRR1	<u>64-Bit</u>	<u>32-Bit</u>						
	0	—	Loaded with equivalent bit from the MSR					
	33	1	Set if the translation of an attempted access is not found in the primary hash table entry group (HTEG), or in the rehashed secondary HTEG, or in the range of an IBAT register (page fault condition); otherwise cleared.					
	34	2	Cleared					
	35	3	Set if the fetch access occurs to a direct-store segment (SR[T] = 1 or STE = 1), to a no-execute segment (N bit set in segment descriptor), or to guarded memory when MSR[IR] = 1. Otherwise, cleared. Note that the direct-store facility is being phased out of the architecture and is not likely to be supported in future devices.					
	36	4	Set if a memory access is not permitted by the page or IBAT protection mechanism, described in Chapter 7, "Memory Management"; otherwise cleared.					
	42	—	For 64-bit implementations, set if the segment table search fails to find a translation for the effective address (segment fault condition); otherwise cleared.					
	43–47	10–15	Cleared					
	48–55	16–23	Loaded with equivalent bits from the MSR					
	57–59	25–27	Loaded with equivalent bits from the MSR					
	62–63	30–31	Loaded with equivalent bits from the MSR					
Note that only one of bits 33, 35, 36, and 42 (bits 1, 3, and 4 in 32-bit implementations) can be set. Also, note that depending on the implementation, additional bits in the MSR may be copied to SRR1.								
MSR	SF *	1	PR	0	SE	0	IR	0
	ISF *	—	FP	0	BE	0	DR	0
	POW	0	ME	—	FE1	0	RI	0
	ILE	—	FE0	0	IP	—	LE	Set to value of ILE
	EE	0						
	TEMPORARY 64-BIT BRIDGE							
* If the MSR[ISF] bit is implemented, the value of the MSR[ISF] bit is copied to the MSR[SF] bit when an exception is taken.								

When an ISI exception is taken, instruction execution resumes at offset 0x00400 from the physical base address determined by MSR[IP].

6.4.5 External Interrupt (0x00500)

An external interrupt exception is signaled to the processor by the assertion of the external interrupt signal. The exception may be delayed by other higher priority exceptions or if the MSR[EE] bit is zero when the exception is detected. Note that the occurrence of this exception does not cancel the external request.

The register settings for the external interrupt exception are shown in Table 6-11.

Table 6-11. External Interrupt—Register Settings

Register	Setting Description							
SRR0	Set to the effective address of the instruction that the processor would have attempted to execute next if no interrupt conditions were present.							
SRR1	<u>64-Bit</u>	<u>32-Bit</u>						
	0	—	Loaded with equivalent bit from the MSR					
	33–36	1–4	Cleared					
	42–47	10–15	Cleared					
	48–55	16–23	Loaded with equivalent bits from the MSR					
	57–59	25–27	Loaded with equivalent bits from the MSR					
	62–63	30–31	Loaded with equivalent bits from the MSR					
Note that depending on the implementation, additional bits in the MSR may be copied to SRR1.								
MSR	SF *	1	PR	0	SE	0	IR	0
	ISF *	—	FP	0	BE	0	DR	0
	POW	0	ME	—	FE1	0	RI	0
	ILE	—	FE0	0	IP	—	LE	Set to value of ILE
	EE	0						
	TEMPORARY 64-BIT BRIDGE							
* If the MSR[ISF] bit is implemented, the value of the MSR[ISF] bit is copied to the MSR[SF] bit when an exception is taken.								

When an external interrupt exception is taken, instruction execution resumes at offset 0x00500 from the physical base address determined by MSR[IP].

6.4.6 Alignment Exception (0x00600)

This section describes conditions that can cause alignment exceptions in the processor. Similar to DSI exceptions, alignment exceptions use the SRR0 and SRR1 to save the machine state and the DSISR to determine the source of the exception. An alignment exception occurs when no higher priority exception exists and the implementation cannot perform a memory access for one of the following reasons:

- The operand of a floating-point load or store instruction is not word-aligned.
- The operand of an integer double-word load or store instruction is not word-aligned.
- The operand of **lmw**, **stmw**, **lwarx**, **ldarx**, **stwcx.**, **stdcx.**, **eciwx**, or **ecowx** is not aligned.
- The instruction is **lmw**, **stmw**, **lswi**, **lswx**, **stswi**, or **stswx** and the processor is in little-endian mode.
- The operand of an elementary or string load or store crosses a protection boundary.
- The operand of **lmw** or **stmw** crosses a segment or BAT boundary.

- The operand of **dcbz** is in memory that is write-through-required or caching inhibited, or **dcbz** is executed in an implementation that has either no data cache or a write-through data cache.
- The operand of a floating-point load or store instruction is in a direct-store segment (T = 1). Note that the direct-store facility is being phased out of the architecture and is not likely to be supported in future devices.

For **lmw**, **stmw**, **lswi**, **lswx**, **stswi**, and **stswx** instructions in little-endian mode, an alignment exception always occurs. For **lmw** and **stmw** instructions with an operand that is not aligned in big-endian mode, and for **lwarx**, **ldarx**, **stwcx.**, **stdcx.**, **eciwx**, and **ecowx** with an operand that is not aligned in either endian mode, an implementation may yield boundedly-undefined results instead of causing an alignment exception (for **eciwx** and **ecowx** when EAR[E] = 0, a third alternative is to cause a DSI exception). For all other cases listed above, an implementation may execute the instruction correctly instead of causing an alignment exception. For the **dcbz** instruction, correct execution means clearing each byte of the block in main memory. See Section 3.1, “Data Organization in Memory and Data Transfers,” for a complete definition of alignment in the PowerPC architecture.

The term, ‘protection boundary’, refers to the boundary between protection domains. A protection domain is a segment, a block of memory defined by a BAT entry, a virtual 4-Kbyte page, or a range of unmapped effective addresses. Protection domains are defined only when the corresponding address translation (instruction or data) is enabled (MSR[IR] or MSR[DR] = 1).

The register settings for alignment exceptions are shown in Table 6-12.

Table 6-12. Alignment Exception—Register Settings

Register	Setting Description							
SRR0	Set to the effective address of the instruction that caused the exception.							
SRR1	64-Bit	32-Bit						
	0	—	Loaded with equivalent bit from the MSR					
	33–36	1–4	Cleared					
	42–47	10–15	Cleared					
	48–55	16–23	Loaded with equivalent bits from the MSR					
	57–59	25–27	Loaded with equivalent bits from the MSR					
	62–63	30–31	Loaded with equivalent bits from the MSR					
Note that depending on the implementation, additional bits in the MSR may be copied to SRR1.								
MSR	SF *	1	PR	0	SE	0	IR	0
	ISF *	—	FP	0	BE	0	DR	0
	POW	0	ME	—	FE1	0	RI	0
	ILE	—	FE0	0	IP	—	LE	Set to value of ILE
	EE	0						

Table 6-12. Alignment Exception—Register Settings (Continued)

Register	Setting Description																														
DSISR	<p>0–14 (32-bit implementations) Cleared 10–11 (64-bit implementations) Cleared 2–13 (64-bit implementations) For 64-bit instructions that use immediate addressing—set to bits 30 and 31. Otherwise cleared. 14 (64-bit implementations) Cleared 15–16 For instructions that use register indirect with index addressing—set to bits 29–30 of the instruction encoding. For instructions that use register indirect with immediate index addressing—cleared 17 For instructions that use register indirect with index addressing—set to bit 25 of the instruction encoding. For instructions that use register indirect with immediate index addressing— set to bit 5 of the instruction encoding. 18–21 For instructions that use register indirect with index addressing—set to bits 21–24 of the instruction encoding. For instructions that use register indirect with immediate index addressing—set to bits 1–4 of the instruction encoding. 22–26 Set to bits 6–10 (identifying either the source or destination) of the instruction encoding. Undefined for dcbz. 27–31 Set to bits 11–15 of the instruction encoding (rA) for update-form instructions Set to either bits 11–15 of the instruction encoding or to any register number not in the range of registers loaded by a valid form instruction for lmw, lswi, and lswx instructions. Otherwise undefined.</p> <p>Note that for load or store instructions that use register indirect with index addressing, the DSISR can be set to the same value that would have resulted if the corresponding instruction uses register indirect with immediate index addressing had caused the exception. Similarly, for load or store instructions that use register indirect with immediate index addressing, DSISR can hold a value that would have resulted from an instruction that uses register indirect with index addressing. For example, a misaligned lwarx instruction that crosses a protection boundary would normally cause the DSISR to be set to the following binary value:</p> <pre>000000000000 00 0 01 0 0101 tttt ?????</pre> <p>The value tttt refers to the destination and ????? indicates undefined bits. However, this register may be set as if the instruction were lwa, as follows: <pre>000000000000 10 0 00 0 1101 tttt ?????</pre></p> <p>If there is no corresponding instruction (such as for the lwarx instruction), no alternative value can be specified.</p> <p>The instruction pairs that can use the same DSISR values are as follows:</p> <table border="0"> <tr> <td>lbz/lbzx</td> <td>lbzu/lbzux</td> <td>lhz/lhzx</td> <td>lhzu/lhzux</td> <td>lha/lhax</td> <td>lhau/lhaux</td> </tr> <tr> <td>lwz/lwzx</td> <td>lwzu/lwzux</td> <td>lwa/lwax</td> <td>ld/ldx</td> <td>ldu/ldux</td> <td>stb/stbx</td> </tr> <tr> <td>stbu/stbux</td> <td>sth/sthx</td> <td>sth/sthux</td> <td>stw/stwx</td> <td>stwu/stwux</td> <td>std/stdx</td> </tr> <tr> <td>stdu/stdux</td> <td>lfs/lfsx</td> <td>lfsu/lfsux</td> <td>lfd/lfdx</td> <td>lfdu/lfdux</td> <td>stfs/stfsx</td> </tr> <tr> <td>stfsu/stfsux</td> <td>stfd/stfdx</td> <td>stfdu/stfdux</td> <td></td> <td></td> <td></td> </tr> </table>	lbz/lbzx	lbzu/lbzux	lhz/lhzx	lhzu/lhzux	lha/lhax	lhau/lhaux	lwz/lwzx	lwzu/lwzux	lwa/lwax	ld/ldx	ldu/ldux	stb/stbx	stbu/stbux	sth/sthx	sth/sthux	stw/stwx	stwu/stwux	std/stdx	stdu/stdux	lfs/lfsx	lfsu/lfsux	lfd/lfdx	lfdu/lfdux	stfs/stfsx	stfsu/stfsux	stfd/stfdx	stfdu/stfdux			
lbz/lbzx	lbzu/lbzux	lhz/lhzx	lhzu/lhzux	lha/lhax	lhau/lhaux																										
lwz/lwzx	lwzu/lwzux	lwa/lwax	ld/ldx	ldu/ldux	stb/stbx																										
stbu/stbux	sth/sthx	sth/sthux	stw/stwx	stwu/stwux	std/stdx																										
stdu/stdux	lfs/lfsx	lfsu/lfsux	lfd/lfdx	lfdu/lfdux	stfs/stfsx																										
stfsu/stfsux	stfd/stfdx	stfdu/stfdux																													
DAR	Set to the EA of the data access as computed by the instruction causing the alignment exception. Note that if a 64-bit processor is running in 32-bit mode, the 32 high-order bits are cleared.																														
<p>TEMPORARY 64-BIT BRIDGE</p> <p>* If the MSR[ISF] bit is implemented, the value of the MSR[ISF] bit is copied to the MSR[SF] bit when an exception is taken.</p>																															

The architecture does not support the use of a misaligned EA by load/store with reservation instructions or by the **eciwx** and **ecowx** instructions. If one of these instructions specifies a misaligned EA, the exception handler should not emulate the instruction but should treat the occurrence as a programming error.

6.4.6.1 Integer Alignment Exceptions

Operations that are not naturally aligned may suffer performance degradation, depending on the processor design, the type of operation, the boundaries crossed, and the mode that the processor is in during execution. More specifically, these operations may either cause an alignment exception or they may cause the processor to break the memory access into multiple, smaller accesses with respect to the cache and the memory subsystem.

6.4.6.1.1 Page Address Translation Access Considerations

A page address translation access occurs when MSR[DR] is set, SR[T] is cleared, and there is no BAT match. Note that a **dcbz** instruction causes an alignment exception if the access is to a page or block with the W (write-through) or I (cache-inhibit) bit set.

Misaligned memory accesses that do not cause an alignment exception may not perform as well as an aligned access of the same type. The resulting performance degradation due to misaligned accesses depends on how well each individual access behaves with respect to the memory hierarchy.

Particular details regarding page address translation is implementation-dependent; the reader should consult the user's manual for the appropriate processor for more information.

6.4.6.1.2 Direct-Store Interface Access Considerations

The following apply for direct-store interface accesses:

- If a 256-Mbyte boundary will be crossed by any portion of the direct-store interface space accessed by an instruction (the entire string for strings/multiples), an alignment exception is taken.
- Floating-point loads and stores to direct-store segments may cause an alignment exception, regardless of operand alignment.
- The load/store word/double word with reservation instructions that map into a direct-store segment always cause a DSI exception. However, if the instruction crosses a segment boundary an alignment exception is taken instead.

Note that the direct-store facility is being phased out of the architecture and is not likely to be supported in future devices.

6.4.6.2 Little-Endian Mode Alignment Exceptions

The OEA allows implementations to take alignment exceptions on misaligned accesses (as described in Section 3.1.4, "PowerPC Byte Ordering") in little-endian mode but does not require them to do so. Some implementations may perform some misaligned accesses without taking an alignment exception.

6.4.6.3 Interpretation of the DSISR as Set by an Alignment Exception

For most alignment exceptions, an exception handler may be designed to emulate the instruction that causes the exception. To do this, the handler requires the following characteristics of the instruction:

- Load or store
- Length (half word, word, or double word)
- String, multiple, or normal load/store
- Integer or floating-point
- Whether the instruction performs update
- Whether the instruction performs byte reversal
- Whether it is a **dcbz** instruction

The PowerPC architecture provides this information implicitly, by setting opcode bits in the DSISR that identify the excepting instruction type. The exception handler does not need to load the excepting instruction from memory. The mapping for all exception possibilities is unique except for the few exceptions discussed below.

Table 6-13 shows the inverse mapping—how the DSISR bits identify the instruction that caused the exception.

The alignment exception handler cannot distinguish a floating-point load or store that causes an exception because it is misaligned, or because it addresses the direct-store interface space. However, this does not matter; in either case it is emulated with integer instructions. Note that the direct-store facility is being phased out of the architecture and is not likely to be supported in future devices.

Table 6-13. DSISR(15–21) Settings to Determine Misaligned Instruction

DSISR[15–21]	Instruction	DSISR[15–21]	Instruction
00 0 0000	lwarx , lwz , special cases ¹	01 1 0010	stdux
00 0 0010	ldarx	01 1 0101	lwaux
00 0 0010	stw	10 0 0010	stwcx.
00 0 0100	lhz	10 0 0011	stdcx.
00 0 0101	lha	10 0 1000	lwbrx
00 0 0110	sth	10 0 1010	stwbrx
00 0 0111	lmw	10 0 1100	lhbrx
00 0 1000	lfs	10 0 1110	sthbrx
00 0 1001	lfd	10 1 0100	eciwx
00 0 1010	stfs	10 1 0110	ecowx
00 0 1011	stfd	10 1 1111	dcbz

Table 6-13. DSISR(15–21) Settings to Determine Misaligned Instruction (Continued)

DSISR[15–21]	Instruction	DSISR[15–21]	Instruction
00 0 1101	ld, ldu, lwa ²	11 0 0000	lwzx
00 0 1111	std, stdu ²	11 0 0010	stwx
00 1 0000	lwzu	11 0 0100	lhzx
00 1 0010	stwu	11 0 0101	lhax
00 1 0100	lhzu	11 0 0110	sthx
00 1 0101	lhau	11 0 1000	lfsx
00 1 0110	sthu	11 0 1001	lfdx
00 1 0111	stmw	11 0 1010	stfsx
00 1 1000	lfsu	11 0 1011	stfdx
00 1 1001	lfdx	11 0 1111	stfiwx
00 1 1010	stfsu	11 1 0000	lwzux
00 1 1011	stfdu	11 1 0010	stwux
01 0 0000	ldx	11 1 0100	lhzux
01 0 0010	stdx	11 1 0101	lhaux
01 0 0101	lwax	11 1 0110	sthux
01 0 1000	lswx	11 1 1000	lfsux
01 0 1001	lswi	11 1 1001	lfdux
01 0 1010	stswx	11 1 1010	stfsux
01 0 1011	stswi	11 1 1011	stfdux
01 1 0000	ldux	—	—

¹The instructions **lwz** and **lwarx** give the same DSISR bits (all zero). But if **lwarx** causes an alignment exception, it is an invalid form, so it need not be emulated in any precise way. It is adequate for the alignment exception handler to simply emulate the instruction as if it were an **lwz**. It is important that the emulator use the address in the DAR, rather than computing it from rA/rB/D, because **lwz** and **lwarx** use different addressing modes.

If opcode 0 (“illegal or reserved”) can cause an alignment exception, it will be indistinguishable to the exception handler from **lwarx** and **lwz**.

²These instructions are distinguished by DSISR[12–13], which are not shown in this table.

6.4.7 Program Exception (0x00700)

A program exception occurs when no higher priority exception exists and one or more of the following exception conditions, which correspond to bit settings in SRR1, occur during execution of an instruction:

- System IEEE floating-point enabled exception—A system IEEE floating-point enabled exception can be generated when FPSCR[FEX] is set and either (or both) of the MSR[FE0] or MSR[FE1] bits is set.

FPSCR[FEX] is set by the execution of a floating-point instruction that causes an enabled exception or by the execution of a “move to FPSCR” type instruction that sets an exception bit when its corresponding enable bit is set. Floating-point exceptions are described in Section 3.3.6, “Floating-Point Program Exceptions.”

- Illegal instruction—An illegal instruction program exception is generated when execution of an instruction is attempted with an illegal opcode or illegal combination of opcode and extended opcode fields (these include PowerPC instructions not implemented in the processor), or when execution of an optional or a reserved instruction not provided in the processor is attempted.

Note that implementations are permitted to generate an illegal instruction program exception when encountering the following instructions. If an illegal instruction exception is not generated, then the alternative is shown in parenthesis.

- An instruction corresponds to an invalid class (the results may be boundedly undefined)
- An **lswx** instruction for which **rA** or **rB** is in the range of registers to be loaded (may cause results that are boundedly undefined)
- A move to/from SPR instruction with an SPR field that does not contain one of the defined values
 - MSR[PR] = 1 and spr[0] = 1 (this can cause a privileged instruction program exception)
 - MSR[PR] = 0 or spr[0] = 0 (may cause boundedly-undefined results.)
- An unimplemented floating-point instruction that is not optional (may cause a floating-point assist exception)

- Privileged instruction—A privileged instruction type program exception is generated when the execution of a privileged instruction is attempted and the processor is operating in user mode (MSR[PR] is set). It is also generated for **mtspr** or **mfspr** instructions that have an invalid SPR field that contain one of the defined values having spr[0] = 1 and if MSR[PR] = 1. Some implementations may also generate a privileged instruction program exception if a specified SPR field (for a move to/from SPR instruction) is not defined for a particular implementation, but spr[0] = 1; in this case, the implementation may cause either a privileged instruction program exception, or an illegal instruction program exception may occur instead.
- Trap—A trap program exception is generated when any of the conditions specified in a trap instruction is met. Trap instructions are described in Section 4.2.4.6, “Trap Instructions.”

The register settings when a program exception is taken are shown in Table 6-14.

Table 6-14. Program Exception—Register Settings

Register	Setting Description																																												
SRR0	The contents of SRR0 differ according to the following situations: <ul style="list-style-type: none"> • For all program exceptions except floating-point enabled exceptions when operating in imprecise mode (MSR[FE0] ≠ MSR[FE1]), SRR0 contains the EA of the excepting instruction. • When the processor is in floating-point imprecise mode, SRR0 may contain the EA of the excepting instruction or that of a subsequent unexecuted instruction. If the subsequent instruction is sync or isync, SRR0 points no more than four bytes beyond the sync or isync instruction. • If FPSCR[FEX] = 1, but IEEE floating-point enabled exceptions are disabled (MSR[FE0] = MSR[FE1] = 0), the program exception occurs before the next synchronizing event if an instruction alters those bits (thus enabling the program exception). When this occurs, SRR0 points to the instruction that would have executed next and not to the instruction that modified MSR. 																																												
SRR1	<table border="0"> <tr> <th>64-Bit</th> <th>32-Bit</th> <th></th> </tr> <tr> <td>0</td> <td>—</td> <td>Loaded with equivalent bit from the MSR</td> </tr> <tr> <td>33–36</td> <td>1–4</td> <td>Cleared</td> </tr> <tr> <td>42</td> <td>10</td> <td>Cleared</td> </tr> <tr> <td>43</td> <td>11</td> <td>Set for an IEEE floating-point enabled program exception; otherwise cleared.</td> </tr> <tr> <td>44</td> <td>12</td> <td>Set for an illegal instruction program exception; otherwise cleared.</td> </tr> <tr> <td>45</td> <td>13</td> <td>Set for a privileged instruction program exception; otherwise cleared.</td> </tr> <tr> <td>46</td> <td>14</td> <td>Set for a trap program exception; otherwise cleared.</td> </tr> <tr> <td>47</td> <td>15</td> <td>Cleared if SRR0 contains the address of the instruction causing the exception, and set if SRR0 contains the address of a subsequent instruction.</td> </tr> <tr> <td>48–55</td> <td>16–23</td> <td>Loaded with equivalent bits from the MSR</td> </tr> <tr> <td>57–59</td> <td>25–27</td> <td>Loaded with equivalent bits from the MSR</td> </tr> <tr> <td>62–63</td> <td>30–31</td> <td>Loaded with equivalent bits from the MSR</td> </tr> </table> <p>Note that depending on the implementation, additional bits in the MSR may be copied to SRR1.</p>	64-Bit	32-Bit		0	—	Loaded with equivalent bit from the MSR	33–36	1–4	Cleared	42	10	Cleared	43	11	Set for an IEEE floating-point enabled program exception; otherwise cleared.	44	12	Set for an illegal instruction program exception; otherwise cleared.	45	13	Set for a privileged instruction program exception; otherwise cleared.	46	14	Set for a trap program exception; otherwise cleared.	47	15	Cleared if SRR0 contains the address of the instruction causing the exception, and set if SRR0 contains the address of a subsequent instruction.	48–55	16–23	Loaded with equivalent bits from the MSR	57–59	25–27	Loaded with equivalent bits from the MSR	62–63	30–31	Loaded with equivalent bits from the MSR								
64-Bit	32-Bit																																												
0	—	Loaded with equivalent bit from the MSR																																											
33–36	1–4	Cleared																																											
42	10	Cleared																																											
43	11	Set for an IEEE floating-point enabled program exception; otherwise cleared.																																											
44	12	Set for an illegal instruction program exception; otherwise cleared.																																											
45	13	Set for a privileged instruction program exception; otherwise cleared.																																											
46	14	Set for a trap program exception; otherwise cleared.																																											
47	15	Cleared if SRR0 contains the address of the instruction causing the exception, and set if SRR0 contains the address of a subsequent instruction.																																											
48–55	16–23	Loaded with equivalent bits from the MSR																																											
57–59	25–27	Loaded with equivalent bits from the MSR																																											
62–63	30–31	Loaded with equivalent bits from the MSR																																											
MSR	<table border="0"> <tr> <td>SF *</td> <td>1</td> <td>PR</td> <td>0</td> <td>SE</td> <td>0</td> <td>IR</td> <td>0</td> </tr> <tr> <td>ISF *</td> <td>—</td> <td>FP</td> <td>0</td> <td>BE</td> <td>0</td> <td>DR</td> <td>0</td> </tr> <tr> <td>POW</td> <td>0</td> <td>ME</td> <td>—</td> <td>FE1</td> <td>0</td> <td>RI</td> <td>0</td> </tr> <tr> <td>ILE</td> <td>—</td> <td>FE0</td> <td>0</td> <td>IP</td> <td>—</td> <td>LE</td> <td>Set to value of ILE</td> </tr> <tr> <td>EE</td> <td>0</td> <td></td> <td></td> <td></td> <td></td> <td></td> <td></td> </tr> </table>	SF *	1	PR	0	SE	0	IR	0	ISF *	—	FP	0	BE	0	DR	0	POW	0	ME	—	FE1	0	RI	0	ILE	—	FE0	0	IP	—	LE	Set to value of ILE	EE	0										
SF *	1	PR	0	SE	0	IR	0																																						
ISF *	—	FP	0	BE	0	DR	0																																						
POW	0	ME	—	FE1	0	RI	0																																						
ILE	—	FE0	0	IP	—	LE	Set to value of ILE																																						
EE	0																																												
TEMPORARY 64-BIT BRIDGE																																													
* If the MSR[ISF] bit is implemented, the value of the MSR[ISF] bit is copied to the MSR[SF] bit when an exception is taken.																																													

When a program exception is taken, instruction execution resumes at offset 0x00700 from the physical base address determined by MSR[IP].

6.4.8 Floating-Point Unavailable Exception (0x00800)

A floating-point unavailable exception occurs when no higher priority exception exists, an attempt is made to execute a floating-point instruction (including floating-point load, store, or move instructions), and the floating-point available bit in the MSR is cleared, (MSR[FP] = 0).

The register settings for floating-point unavailable exceptions are shown in Table 6-15.

Table 6-15. Floating-Point Unavailable Exception—Register Settings

Register	Setting Description							
SRR0	Set to the effective address of the instruction that caused the exception.							
SRR1	64-Bit	32-Bit						
	0	—	Loaded with equivalent bit from the MSR					
	33–36	1–4	Cleared					
	42–47	10–15	Cleared					
	48–55	16–23	Loaded with equivalent bits from the MSR					
	57–59	25–27	Loaded with equivalent bits from the MSR					
	62–63	30–31	Loaded with equivalent bits from the MSR					
Note that depending on the implementation, additional bits in the MSR may be copied to SRR1.								
MSR	SF *	1	PR	0	SE	0	IR	0
	ISF *	—	FP	0	BE	0	DR	0
	POW	0	ME	—	FE1	0	RI	0
	ILE	—	FE0	0	IP	—	LE	Set to value of ILE
	EE	0						
	TEMPORARY 64-BIT BRIDGE							
* If the MSR[ISF] bit is implemented, the value of the MSR[ISF] bit is copied to the MSR[SF] bit when an exception is taken.								

When a floating-point unavailable exception is taken, instruction execution resumes at offset 0x00800 from the physical base address determined by MSR[IP].

6.4.9 Decrementer Exception (0x00900)

A decrementer exception occurs when no higher priority exception exists, a decrementer exception condition occurs (for example, the decrementer register has completed decrementing), and MSR[EE] = 1. The decrementer register counts down, causing an exception request when it passes through zero. A decrementer exception request remains pending until the decrementer exception is taken and then it is cancelled. The decrementer implementation meets the following requirements:

- The counters for the decrementer and the time-base counter are driven by the same fundamental time base.
- Loading a GPR from the decrementer does not affect the decrementer.

- Storing a GPR value to the decremter replaces the value in the decremter with the value in the GPR.
- Whenever bit 0 of the decremter changes from 0 to 1, a decremter exception request is signaled. If multiple decremter exception requests are received before the first can be reported, only one exception is reported. The occurrence of a decremter exception cancels the request.
- If the decremter is altered by software and if bit 0 is changed from 0 to 1, an exception request is signaled.

The register settings for the decremter exception are shown in Table 6-16.

Table 6-16. Decremter Exception—Register Settings

Register	Setting Description																																								
SRR0	Set to the effective address of the instruction that the processor would have attempted to execute next if no exception conditions were present.																																								
SRR1	<table border="0"> <tr> <td><u>64-Bit</u></td> <td><u>32-Bit</u></td> <td></td> </tr> <tr> <td>0</td> <td>—</td> <td>Loaded with equivalent bit from the MSR</td> </tr> <tr> <td>33–36</td> <td>1–4</td> <td>Cleared</td> </tr> <tr> <td>42–47</td> <td>10–15</td> <td>Cleared</td> </tr> <tr> <td>48–55</td> <td>16–23</td> <td>Loaded with equivalent bits from the MSR</td> </tr> <tr> <td>57–59</td> <td>25–27</td> <td>Loaded with equivalent bits from the MSR</td> </tr> <tr> <td>62–63</td> <td>30–31</td> <td>Loaded with equivalent bits from the MSR</td> </tr> </table> <p>Note that depending on the implementation, additional bits in the MSR may be copied to SRR1.</p>	<u>64-Bit</u>	<u>32-Bit</u>		0	—	Loaded with equivalent bit from the MSR	33–36	1–4	Cleared	42–47	10–15	Cleared	48–55	16–23	Loaded with equivalent bits from the MSR	57–59	25–27	Loaded with equivalent bits from the MSR	62–63	30–31	Loaded with equivalent bits from the MSR																			
<u>64-Bit</u>	<u>32-Bit</u>																																								
0	—	Loaded with equivalent bit from the MSR																																							
33–36	1–4	Cleared																																							
42–47	10–15	Cleared																																							
48–55	16–23	Loaded with equivalent bits from the MSR																																							
57–59	25–27	Loaded with equivalent bits from the MSR																																							
62–63	30–31	Loaded with equivalent bits from the MSR																																							
MSR	<table border="0"> <tr> <td>SF *</td> <td>1</td> <td>PR</td> <td>0</td> <td>SE</td> <td>0</td> <td>IR</td> <td>0</td> </tr> <tr> <td>ISF *</td> <td>—</td> <td>FP</td> <td>0</td> <td>BE</td> <td>0</td> <td>DR</td> <td>0</td> </tr> <tr> <td>POW</td> <td>0</td> <td>ME</td> <td>—</td> <td>FE1</td> <td>0</td> <td>RI</td> <td>0</td> </tr> <tr> <td>ILE</td> <td>—</td> <td>FE0</td> <td>0</td> <td>IP</td> <td>—</td> <td>LE</td> <td>Set to value of ILE</td> </tr> <tr> <td>EE</td> <td>0</td> <td></td> <td></td> <td></td> <td></td> <td></td> <td></td> </tr> </table>	SF *	1	PR	0	SE	0	IR	0	ISF *	—	FP	0	BE	0	DR	0	POW	0	ME	—	FE1	0	RI	0	ILE	—	FE0	0	IP	—	LE	Set to value of ILE	EE	0						
SF *	1	PR	0	SE	0	IR	0																																		
ISF *	—	FP	0	BE	0	DR	0																																		
POW	0	ME	—	FE1	0	RI	0																																		
ILE	—	FE0	0	IP	—	LE	Set to value of ILE																																		
EE	0																																								
<p>TEMPORARY 64-BIT BRIDGE</p> <p>* If the MSR[ISF] bit is implemented, the value of the MSR[ISF] bit is copied to the MSR[SF] bit when an exception is taken.</p>																																									

When a decremter exception is taken, instruction execution resumes at offset 0x00900 from the physical base address determined by MSR[IP].

6.4.10 System Call Exception (0x00C00)

A system call exception occurs when a System Call (sc) instruction is executed. The effective address of the instruction following the sc instruction is placed into SRR0. MSR bits are saved in SRR1, as shown in Table 6-17. Then a system call exception is generated.

The system call exception causes the next instruction to be fetched from offset 0x00C00 from the physical base address determined by the new setting of MSR[IP]. As with most other exceptions, this exception is context-synchronizing. Refer to Section 6.1.2.1, “Context Synchronization,” for more information on the actions performed by a context-synchronizing operation. Register settings are shown in Table 6-17.

Table 6-17. System Call Exception—Register Settings

Register	Setting Description																																								
SRR0	Set to the effective address of the instruction following the System Call instruction																																								
SRR1	<table border="0"> <tr> <td>64-Bit</td> <td>32-Bit</td> <td></td> </tr> <tr> <td>0</td> <td>—</td> <td>Loaded with equivalent bit from the MSR</td> </tr> <tr> <td>33–36</td> <td>1–4</td> <td>Cleared</td> </tr> <tr> <td>42–47</td> <td>10–15</td> <td>Cleared</td> </tr> <tr> <td>48–55</td> <td>16–23</td> <td>Loaded with equivalent bits from the MSR</td> </tr> <tr> <td>57–59</td> <td>25–27</td> <td>Loaded with equivalent bits from the MSR</td> </tr> <tr> <td>62–63</td> <td>30–31</td> <td>Loaded with equivalent bits from the MSR</td> </tr> </table> <p>Note that depending on the implementation, additional bits in the MSR may be copied to SRR1.</p>	64-Bit	32-Bit		0	—	Loaded with equivalent bit from the MSR	33–36	1–4	Cleared	42–47	10–15	Cleared	48–55	16–23	Loaded with equivalent bits from the MSR	57–59	25–27	Loaded with equivalent bits from the MSR	62–63	30–31	Loaded with equivalent bits from the MSR																			
64-Bit	32-Bit																																								
0	—	Loaded with equivalent bit from the MSR																																							
33–36	1–4	Cleared																																							
42–47	10–15	Cleared																																							
48–55	16–23	Loaded with equivalent bits from the MSR																																							
57–59	25–27	Loaded with equivalent bits from the MSR																																							
62–63	30–31	Loaded with equivalent bits from the MSR																																							
MSR	<table border="0"> <tr> <td>SF *</td> <td>1</td> <td>PR</td> <td>0</td> <td>SE</td> <td>0</td> <td>IR</td> <td>0</td> </tr> <tr> <td>ISF *</td> <td>—</td> <td>FP</td> <td>0</td> <td>BE</td> <td>0</td> <td>DR</td> <td>0</td> </tr> <tr> <td>POW</td> <td>0</td> <td>ME</td> <td>—</td> <td>FE1</td> <td>0</td> <td>RI</td> <td>0</td> </tr> <tr> <td>ILE</td> <td>—</td> <td>FE0</td> <td>0</td> <td>IP</td> <td>—</td> <td>LE</td> <td>Set to value of ILE</td> </tr> <tr> <td>EE</td> <td>0</td> <td></td> <td></td> <td></td> <td></td> <td></td> <td></td> </tr> </table>	SF *	1	PR	0	SE	0	IR	0	ISF *	—	FP	0	BE	0	DR	0	POW	0	ME	—	FE1	0	RI	0	ILE	—	FE0	0	IP	—	LE	Set to value of ILE	EE	0						
SF *	1	PR	0	SE	0	IR	0																																		
ISF *	—	FP	0	BE	0	DR	0																																		
POW	0	ME	—	FE1	0	RI	0																																		
ILE	—	FE0	0	IP	—	LE	Set to value of ILE																																		
EE	0																																								
<p>TEMPORARY 64-BIT BRIDGE</p> <p>* If the MSR[ISF] bit is implemented, the value of the MSR[ISF] bit is copied to the MSR[SF] bit when an exception is taken.</p>																																									

When a system call exception is taken, instruction execution resumes at offset 0x00C00 from the physical base address determined by MSR[IP].

6.4.11 Trace Exception (0x00D00)

The trace exception is optional to the PowerPC architecture, and specific information about how it is implemented can be found in user’s manuals for individual processors.

The trace exception provides a means of tracing the flow of control of a program for debugging and performance analysis purposes. It is controlled by MSR bits SE and BE as follows:

- MSR[SE] = 1: the processor generates a single-step type trace exception after each instruction that completes without causing an exception or context change (such as occurs when an **sc**, **rfd** (or **rfi**), or a load instruction that causes an exception, for example, is executed).
- MSR[BE] = 1: the processor generates a branch-type trace exception after completing the execution of a branch instruction, whether or not the branch is taken.

If this facility is implemented, a trace exception occurs when no higher priority exception exists and either of the conditions described above exist. The following are not traced:

- **rfd** (or **rfi**) instruction
- **sc**, and trap instructions that trap
- Other instructions that cause exceptions (other than trace exceptions)
- The first instruction of any exception handler
- Instructions that are emulated by software

MSR[SE, BE] are both cleared when the trace exception is taken. In the normal use of this function, MSR[SE, BE] are restored when the exception handler returns to the interrupted program using an **rfd** (or **rfi**) instruction.

Register settings for the trace mode are described in Table 6-18.

Table 6-18. Trace Exception—Register Settings

Register	Setting Description																																								
SRR0	Set to the effective address of the next instruction to be executed in the program for which the trace exception was generated.																																								
SRR1	<table border="0"> <tr> <td>64-Bit</td> <td>32-Bit</td> <td></td> </tr> <tr> <td>0</td> <td>—</td> <td>Loaded with equivalent bit from the MSR</td> </tr> <tr> <td>33–36</td> <td>1–4</td> <td>Cleared</td> </tr> <tr> <td>42–47</td> <td>10–15</td> <td>Cleared</td> </tr> <tr> <td>48–55</td> <td>16–23</td> <td>Loaded with equivalent bits from the MSR</td> </tr> <tr> <td>57–59</td> <td>25–27</td> <td>Loaded with equivalent bits from the MSR</td> </tr> <tr> <td>62–63</td> <td>30–31</td> <td>Loaded with equivalent bits from the MSR</td> </tr> </table> <p>Note that depending on the implementation, additional bits in the MSR may be copied to SRR1.</p>	64-Bit	32-Bit		0	—	Loaded with equivalent bit from the MSR	33–36	1–4	Cleared	42–47	10–15	Cleared	48–55	16–23	Loaded with equivalent bits from the MSR	57–59	25–27	Loaded with equivalent bits from the MSR	62–63	30–31	Loaded with equivalent bits from the MSR																			
64-Bit	32-Bit																																								
0	—	Loaded with equivalent bit from the MSR																																							
33–36	1–4	Cleared																																							
42–47	10–15	Cleared																																							
48–55	16–23	Loaded with equivalent bits from the MSR																																							
57–59	25–27	Loaded with equivalent bits from the MSR																																							
62–63	30–31	Loaded with equivalent bits from the MSR																																							
MSR	<table border="0"> <tr> <td>SF *</td> <td>1</td> <td>PR</td> <td>0</td> <td>SE</td> <td>0</td> <td>IR</td> <td>0</td> </tr> <tr> <td>ISF *</td> <td>—</td> <td>FP</td> <td>0</td> <td>BE</td> <td>0</td> <td>DR</td> <td>0</td> </tr> <tr> <td>POW</td> <td>0</td> <td>ME</td> <td>—</td> <td>FE1</td> <td>0</td> <td>RI</td> <td>0</td> </tr> <tr> <td>ILE</td> <td>—</td> <td>FE0</td> <td>0</td> <td>IP</td> <td>—</td> <td>LE</td> <td>Set to value of ILE</td> </tr> <tr> <td>EE</td> <td>0</td> <td></td> <td></td> <td></td> <td></td> <td></td> <td></td> </tr> </table>	SF *	1	PR	0	SE	0	IR	0	ISF *	—	FP	0	BE	0	DR	0	POW	0	ME	—	FE1	0	RI	0	ILE	—	FE0	0	IP	—	LE	Set to value of ILE	EE	0						
SF *	1	PR	0	SE	0	IR	0																																		
ISF *	—	FP	0	BE	0	DR	0																																		
POW	0	ME	—	FE1	0	RI	0																																		
ILE	—	FE0	0	IP	—	LE	Set to value of ILE																																		
EE	0																																								
<p>TEMPORARY 64-BIT BRIDGE</p> <p>* If the MSR[ISF] bit is implemented, the value of the MSR[ISF] bit is copied to the MSR[SF] bit when an exception is taken.</p>																																									

When a trace exception is taken, instruction execution resumes at offset 0x00D00 from the base address determined by MSR[IP].

6.4.12 Floating-Point Assist Exception (0x00E00)

The floating-point assist exception is optional to the PowerPC architecture. It can be used to allow software to assist in the following situations:

- Execution of floating-point instructions for which an implementation uses software routines to perform certain operations, such as those involving denormalization.
- Execution of floating-point instructions that are not optional and are not implemented in hardware. In this case, the processor may generate an illegal instruction type program exception instead.

Register settings for the floating-point assist exceptions are described in Table 6-19.

Table 6-19. Floating-Point Assist Exception—Register Settings

Register	Setting Description			
SRR0	Set to the address of the next instruction to be executed in the program for which the floating-point assist exception was generated.			
SRR1	64-Bit	32-Bit		
	0	—	Loaded with equivalent bit from the MSR	
	33–36	1–4	Implementation-specific information	
	42–47	10–15	Implementation-specific information	
	48–55	16–23	Loaded with equivalent bits from the MSR	
	57–59	25–27	Loaded with equivalent bits from the MSR	
	62–63	30–31	Loaded with equivalent bits from the MSR	
	Note that depending on the implementation, additional bits in the MSR may be copied to SRR1.			
MSR	SF [*] 1	PR 0	SE 0	IR 0
	ISF [*] —	FP 0	BE 0	DR 0
	POW 0	ME —	FE1 0	RI 0
	ILE —	FE0 0	IP —	LE Set to value of ILE
	EE 0			
TEMPORARY 64-BIT BRIDGE				
* If the MSR[ISF] bit is implemented, the value of the MSR[ISF] bit is copied to the MSR[SF] bit when an exception is taken..				

When a floating-point assist exception is taken, instruction execution resumes as offset 0x00E00 from the base address determined by MSR[IP].

Chapter 7

Memory Management

This chapter describes the memory management unit (MMU) specifications provided by the PowerPC operating environment architecture (OEA) for PowerPC processors. The primary function of the MMU in a PowerPC processor is to translate logical (effective) addresses to physical addresses (referred to as real addresses in the architecture specification) for memory accesses and I/O accesses (most I/O accesses are assumed to be memory-mapped). In addition, the MMU provides various levels of access protection on a segment, block, or page basis. Note that there are many aspects of memory management that are implementation-dependent. This chapter describes the conceptual model of a PowerPC MMU; however, PowerPC processors may differ in the specific hardware used to implement the MMU model of the OEA, depending on the many design trade-offs inherent in each implementation.

Two general types of accesses generated by PowerPC processors require address translation—instruction accesses, and data accesses to memory generated by load and store instructions. In addition, the addresses specified by cache instructions and the optional external control instructions also require translation. Generally, the address translation mechanism is defined in terms of segment descriptors and page tables used by PowerPC processors to locate the effective to physical address mapping for instruction and data accesses. The segment information translates the effective address to an interim virtual address, and the page table information translates the virtual address to a physical address.

The definition of the segment and page table data structures provides significant flexibility for the implementation of performance enhancement features in a wide range of processors. Therefore, the performance enhancements used to store the segment or page table information on-chip vary from implementation to implementation.

Translation lookaside buffers (TLBs) are commonly implemented in PowerPC processors to keep recently-used page address translations on-chip. Although their exact characteristics are not specified in the OEA, the general concepts that are pertinent to the system software are described.

The segment information, used to generate the interim virtual addresses, is stored as segment descriptors. These descriptors may reside in on-chip segment registers (32-bit implementations) or as segment table entries (STEs) in memory (64-bit implementations). In much the same way that TLBs cache recently-used page address translations, 64-bit

processors may contain segment lookaside buffers (SLBs) on-chip that cache recently-used segment table entries. Although the exact characteristics of SLBs are not specified, there is general information pertinent to those implementations that provide SLBs.

TEMPORARY 64-BIT BRIDGE

The OEA defines an additional, optional bridge to the 64-bit architecture that may make it easier for 32-bit operating systems to migrate to 64-bit processors. The 64-bit bridge retains certain aspects of the 32-bit architecture that otherwise are not supported, and in some cases not permitted, by the 64-bit version of the architecture. In processors that implement this bridge, segment descriptors are implemented by using 16 SLB entries to emulate segment registers, which, like those defined for the 32-bit architecture, divide the 32-bit memory space (4 Gbytes) into sixteen 256-Mbyte segments. These segment descriptors however use the format of the segment table entries as defined in the 64-bit architecture and are maintained in SLBs rather than in architecture-defined segment registers.

The block address translation (BAT) mechanism is a software-controlled array that stores the available block address translations on-chip. BAT array entries are implemented as pairs of BAT registers that are accessible as supervisor special-purpose registers (SPRs).

The MMU, together with the exception processing mechanism, provides the necessary support for the operating system to implement a paged virtual memory environment and for enforcing protection of designated memory areas. Exception processing is described in Chapter 6, “Exceptions.” Section 2.3.1, “Machine State Register (MSR),” describes the MSR, which controls some of the critical functionality of the MMU. (Note that the architecture specification refers to exceptions as interrupts.)

7.1 MMU Features

The memory management specification of the PowerPC OEA includes models for both 64- and 32-bit implementations. The MMU of a 64-bit PowerPC processor provides 2^{64} bytes of effective address space accessible to supervisor and user programs with a 4-Kbyte page size and 256-Mbyte segment size. PowerPC processors also have a block address translation (BAT) mechanism for mapping large blocks of memory. Block sizes range from 128 Kbyte to 256 Mbyte and are software-selectable. In addition, the MMU of 64-bit PowerPC processors uses an interim virtual address (80 bits or 64 bits) and hashed page tables in the generation of physical addresses that are ≤ 64 bits in length.

The MMU of a 32-bit PowerPC processor is similar except that it provides 4 Gbytes of effective address space, a 52-bit interim virtual address and physical addresses that are ≤ 32 bits in length. Table 7-1 summarizes the features of PowerPC MMUs for 64-bit implementations and highlights the differences for 32-bit implementations.

Table 7-1. MMU Features Summary

Feature Category	64-Bit Implementations		32-Bit Implementations
	Conventional	TEMPORARY 64-BIT BRIDGE	
Address ranges	2^{64} bytes of effective address	2^{32} bytes of effective address	2^{32} bytes of effective address
	2^{80} bytes of virtual address or 2^{64} bytes of virtual address	2^{52} bytes of virtual address	2^{52} bytes of virtual address
	$\leq 2^{64}$ bytes of physical address	$\leq 2^{32}$ bytes of physical address	$\leq 2^{32}$ bytes of physical address
Page size	4 Kbytes	Same	Same
Segment size	256 Mbytes	Same	Same
Block address translation	Range of 128 Kbyte–256 Mbyte	Same	Same
	Implemented with IBAT and DBAT registers in BAT array	Same	Same
Memory protection	Segments selectable as no-execute	Same	Same
	Pages selectable as user/supervisor and read-only	Same	Same
	Blocks selectable as user/supervisor and read-only	Same	Same
Page history	Referenced and changed bits defined and maintained	Same	Same
Page address translation	Translations stored as PTEs in hashed page tables in memory	Same	Different format for PTEs (supports 32-bit translation)
	Page table size determined by size programmed into SDR1 register	Page table size determined by size programmed into SDR1 register	Different format for SDR1 to support 32-bit translation; page table size programmed into SDR1 as a mask
TLBs	Instructions for maintaining optional TLBs	Same	Same
Segment descriptors	Stored as STEs in hashed segment tables in memory	Stored in 16 SLB entries in the same format as the STEs defined for 64-bit implementations.	Stored as segment registers on-chip (different format)
	Instructions for maintaining optional SLBs	16 SLB entries are required to emulate the segment registers defined for 32-bit addressing. The slbie and slbia instructions should not be executed when using the 64-bit bridge.	No SLBs supported

Note that this chapter describes address translation mechanisms from the perspective of the programming model. As such, it describes the structure of the page and segment tables, the

MMU conditions that cause exceptions, the instructions provided for programming the MMU, and the MMU registers. The hardware implementation details of a particular MMU (including whether the hardware automatically performs a page table search in memory) are not contained in the architectural definition of PowerPC processors and are invisible to the PowerPC programming model; therefore, they are not described in this document. In the case that some of the OEA model is implemented with some software assist mechanism, this software should be contained in the area of memory reserved for implementation-specific use and should not be visible to the operating system.

TEMPORARY 64-BIT BRIDGE

In addition to the features described above, the OEA provides optional features that facilitate the migration of operating systems from 32-bit processor designs to 64-bit processors. These features, which can be implemented in part or in whole, include the following:

- Support for several 32-bit instructions that are otherwise defined as illegal in 64-bit processors. These include the following—**mtsr**, **mtsrin**, **mfsr**, **mfsrin**.
- Additional instructions, **mtsr** and **mtsrin**, that allow software to associate effective segments 0–15 with any of virtual segments 0–($2^{52} - 1$) without otherwise affecting the segment table. These instructions move 64 bits from a specified GPR to a selected SLB entry.
- The **rfi** and **mtmsr** instructions, which are otherwise illegal in the 64-bit architecture may optionally be implemented in 64-bit implementations.
- The bridge defines the following additional optional bits:
 - ASR[V] (bit 63) may be implemented to indicate whether ASR[STABORG] holds a valid physical base address for the segment table.
 - MSR[ISF] (bit 2) is defined as an optional bit that can be used to control the mode (64-bit or 32-bit) that is entered when an exception is taken. If the bit is implemented, it should have the properties described in Section 7.9.1, “ISF Bit of the Machine State Register.” Otherwise, it is treated as reserved, except that ISF is assumed to be set for exception processing.

To determine whether a processor implements any or all of the bridge features, consult the user’s manual for that processor.

7.2 MMU Overview

The PowerPC MMU and exception models support demand-paged virtual memory. Virtual memory management permits execution of programs larger than the size of physical memory; the term demand paged implies that individual pages are loaded into physical memory from backing storage only as they are accessed by an executing program.

The memory management model includes the concept of a virtual address that is not only larger than that of the maximum physical memory allowed but a virtual address space that is also larger than the effective address space. Effective addresses generated by 64-bit implementations are 64 bits wide; those generated by 32-bit implementations are 32 bits wide. In the address translation process, the processor converts an effective address to an 80-bit (or 64-bit) virtual address in 64-bit implementations, or to a 52-bit virtual address in 32-bit implementations, as per the information in the selected descriptor. Then the address is translated back to a physical address the size (or less) of the effective address.

64-bit implementations have the option of supporting either an 80-bit or a 64-bit virtual address range. The remainder of this chapter describes the virtual address for 64-bit processors as consisting of 80 bits. For implementations that support the 64-bit virtual address range, the high-order 16 bits of the 80-bit virtual address are assumed to be zero.

Note that in the cases that 64-bit (or 32-bit) implementations support a physical address range that is smaller than 64 bits (or 32 bits), the higher-order bits of the effective address may be ignored in the address translation process. The remainder of this chapter assumes that implementations support the maximum physical address range.

The operating system manages the system's physical memory resources. Consequently, the operating system initializes the MMU registers (segment registers or address space register (ASR), BAT registers, and SDR1 register) and sets up page tables (and segment tables for 64-bit implementations) in memory appropriately. The MMU then assists the operating system by managing page status and optionally caching the recently-used address translation information on-chip for quick access.

Effective address spaces are divided into 256-Mbyte regions called segments or into other large regions called blocks (128 Kbyte–256 Mbyte). Segments that correspond to memory-mapped areas can be further subdivided into 4-Kbyte pages. For each block or page, the operating system creates an address descriptor (page table entry (PTE) or BAT array entry); the MMU then uses these descriptors to generate the physical address, the protection information, and other access control information each time an address within the block or page is accessed. Address descriptors for pages reside in tables (as PTEs) in physical memory; for faster accesses, the MMU often caches on-chip copies of recently-used PTEs in an on-chip TLB. The MMU keeps the block information on-chip in the BAT array (comprised of the BAT registers).

This section provides an overview of the high-level organization and operational concepts of the MMU in PowerPC processors, and a summary of all MMU control registers. For more information about the MSR, see Section 2.3.1, “Machine State Register (MSR).” Section 7.4.3, “BAT Register Implementation of BAT Array,” describes the BAT registers, Section 7.5.2.1, “Segment Descriptor Definitions,” describes the segment registers, Section 7.6.1.1, “SDR1 Register Definitions,” describes the SDR1, and Section 7.7.1.1, “Address Space Register (ASR),” describes the ASR.

7.2.1 Memory Addressing

A program references memory using the effective (logical) address computed by the processor when it executes a load, store, branch, or cache instruction, and when it fetches the next instruction. The effective address is translated to a physical address according to the procedures described throughout this chapter. The memory subsystem uses the physical address for the access.

7.2.1.1 Effective Addresses in 32-Bit Mode

In addition to the 64-and 32-bit memory management models defined by the OEA, the PowerPC architecture also defines a 32-bit mode of operation for 64-bit implementations. In this 32-bit mode ($MSR[SF] = 0$), the 64-bit effective address is first calculated as usual, and then the high-order 32 bits of the EA are treated as zero for the purposes of addressing memory. This occurs for both instruction and data accesses, and occurs independently from the setting of the $MSR[IR]$ and $MSR[DR]$ bits that enable instruction and data address translation, respectively. The truncation of the EA is the only way in which memory accesses are affected by the 32-bit mode of operation.

TEMPORARY 64-BIT BRIDGE

Some 64-bit processors implement optional features that simplify the conversion of an operating system from the 32-bit to the 64-bit portion of the architecture. This architecturally-defined bridge allows an operating system to use 16 on-chip SLB entries in the same manner that 32-bit implementations use the segment registers, which are otherwise not supported in the 64-bit architecture. These bridge features are available if the $ASR[V]$ bit is implemented, and they are enabled when both $ASR[V]$ and $MSR[SF]$ are cleared.

For a complete discussion of effective address calculation, see Section 4.1.4.2, “Effective Address Calculation.”

7.2.1.2 Predefined Physical Memory Locations

There are four areas of the physical memory map that have predefined uses. The first 256 bytes of physical memory (or if $MSR[IP] = 1$, the first 256 bytes of memory located at physical address $0xFFFF0_0000$ in 32-bit implementations and $0x0000_0000_FFF0_0000$ in 64-bit implementations) are assigned for arbitrary use by the operating system. The rest of that first page of physical memory defined by the vector base address (determined by $MSR[IP]$) is either used for exception vectors, or reserved for future exception vectors. The third predefined area of memory consists of the second and third physical pages of the memory map, which are used for implementation-specific purposes. In some implementations, the second and third pages located at physical address $0xFFFF0_1000$ in 32-bit implementations and $0x0000_0000_FFF0_1000$ in 64-bit implementations when $MSR[IP] = 1$ are also used for implementation-specific purposes. Fourthly, the system software defines the locations in physical memory that contain the page address translation tables (and segment descriptor tables, in 64-bit implementations). These predefined

memory areas are summarized in Table 7-2 in terms of the variable ‘Base’ and Table 7-3 decodes the actual value of ‘Base’. Refer to Chapter 6, “Exceptions,” for more detailed information on the assignment of the exception vector offsets.

Table 7-2. Predefined Physical Memory Locations

Memory Area	Physical Address Range	Predefined Use
1	Base 0x0_0000–Base 0x0_00FF	Operating system
2	Base 0x0_0100–Base 0x0_0FFF	Exception vectors
3	Base 0x0_1000–Base 0x0_2FFF	Implementation-specific ¹
4	Software-specified—contiguous sequence of physical pages	Page table
	Software-specified—single physical page	Segment table (64-bit implementations only)

¹Only valid for MSR[IP] = 1 on some implementations

Table 7-3. Value of Base for Predefined Memory Use

MSR[IP]	Value of Base
0	Base = 0x000 for 32-bit implementations Base = 0x0000_0000_000 for 64-bit implementations
1	Base = 0xFFF for 32-bit implementations Base = 0x0000_0000_FFF for 64-bit implementations

7.2.2 MMU Organization

Figure 7-1 shows the conceptual organization of the MMU in a 64-bit implementation; note that it does not describe the specific hardware used to implement the memory management function for a particular processor, and other hardware features (invisible to the system software) not depicted in the figure may be implemented. For example, the memory management function can be implemented with parallel MMUs that translate addresses for instruction and data accesses independently.

The instruction addresses shown in the figure are generated by the processor for sequential instruction fetches and addresses that correspond to a change of program flow. Memory addresses are generated by load and store instructions, by cache instructions, and by the optional external control instructions.

As shown in Figure 7-1, after an address is generated, the higher-order bits of the effective address, EA0–EA51 (or a smaller set of address bits, EA0–EA n , in the cases of blocks), are translated into physical address bits PA0–PA51. The lower-order address bits, A52–A63 are untranslated and therefore identical for both effective and physical addresses. After translating the address, the MMU passes the resulting 64-bit physical address to the memory subsystem.

In addition to the higher-order address bits, the MMU automatically keeps an indicator of whether each access was generated as an instruction or data access and a supervisor/user indicator that reflects the state of the MSR[PR] bit when the effective address was generated. In addition, for data accesses, there is an indicator of whether the access is for a load or a store operation. This information is then used by the MMU to appropriately direct the address translation and to enforce the protection hierarchy programmed by the operating system. See Section 2.3.1, “Machine State Register (MSR),” for more information about the MSR.

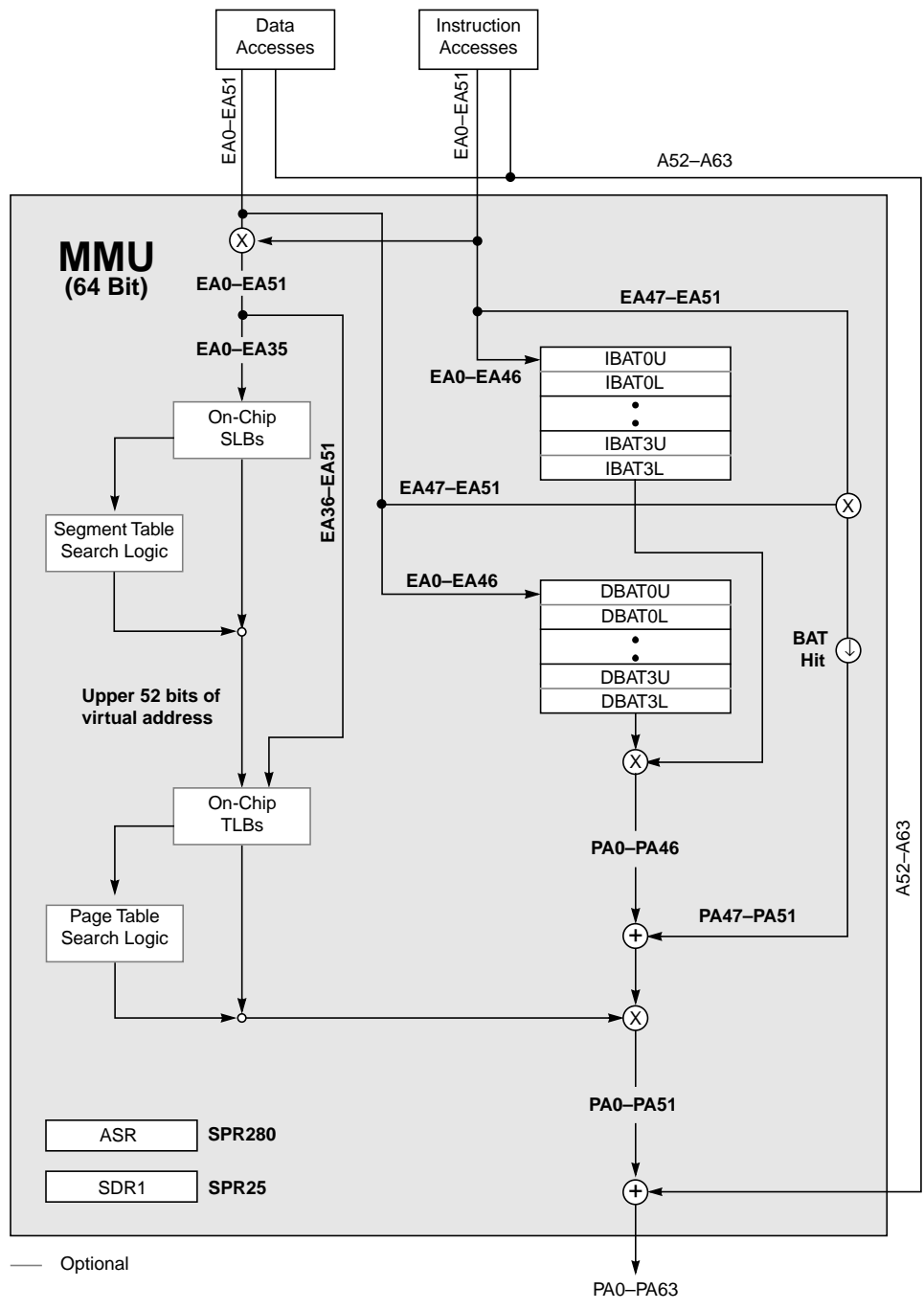

Figure 7-1. MMU Conceptual Block Diagram—64-Bit Implementations

As shown in Figure 7-1, processors optionally implement on-chip translation lookaside buffers (TLBs) and optionally support the automatic search of the page tables for page table entries (PTEs).

In 64-bit implementations, the address space register (ASR) defines the physical address of the base of the segment table in memory. The segment table entries (STEs) contain the segment descriptors, which define the virtual address for the segment. Some 64-bit implementations may have dedicated hardware to search for STEs in memory, and copies of STEs may be cached on-chip in segment lookaside buffers (SLBs) for quicker access.

TEMPORARY 64-BIT BRIDGE

Processors that implement the 64-bit bridge implement segment descriptors as a table of 16 segment table entries.

Figure 7-2 shows a conceptual block diagram of the MMU in a 32-bit implementation. The 32-bit MMU implementation differs from the 64-bit implementation in that after an address is generated, the higher-order bits of the effective address, EA0–EA19 (or a smaller set of address bits, EA0–EA n , in the cases of blocks), are translated into physical address bits PA0–PA19. The lower-order address bits, A20–A31 are untranslated and therefore identical for both effective and physical addresses. After translating the address, the MMU passes the resulting 32-bit physical address to the memory subsystem.

Also, whereas 64-bit implementations use the ASR and a segment table to generate the 80-bit virtual address, 32-bit implementations use the 16 segment registers to generate the 52-bit virtual address.

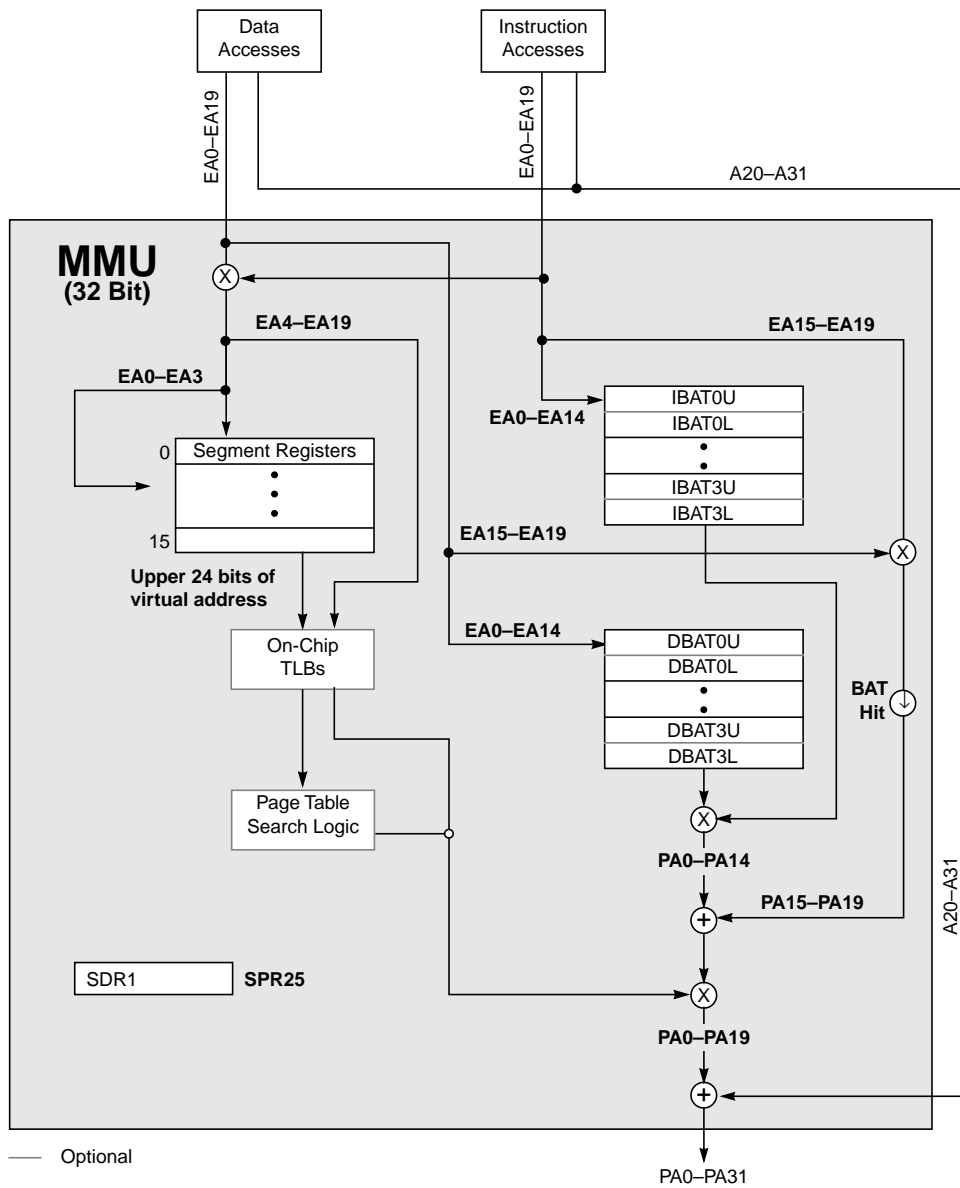

Figure 7-2. MMU Conceptual Block Diagram—32-Bit Implementations

7.2.3 Address Translation Mechanisms

PowerPC processors support the following three types of address translation:

- Page address translation—translates the page frame address for a 4-Kbyte page size
- Block address translation—translates the block number for blocks that range in size from 128 Kbyte to 256 Mbyte
- Real addressing mode address translation—when address translation is disabled, the physical address is identical to the effective address.

In addition, earlier processors implement a direct-store facility that is used to generate direct-store interface accesses on the external bus. Note that this facility is not optimized for performance, was present for compatibility with POWER devices, and is being phased out of the architecture. Future devices are not likely to support it; software should not depend on its effects and new software should not use it.

Figure 7-3 shows the address translation mechanisms provided by the MMU. The segment descriptors shown in the figure control both the page and direct-store segment address translation mechanisms. When an access uses the page or direct-store segment address translation, the appropriate segment descriptor is required. In 64-bit implementations, the segment descriptor is located via a search of the segment table in memory for the appropriate segment table entry (STE). In 32-bit implementations, one of the 16 on-chip segment registers (which contain segment descriptors) is selected by the highest-order effective address bits.

TEMPORARY 64-BIT BRIDGE

Processors that implement the 64-bit bridge divide the 32-bit address space into sixteen 256-Mbyte segments defined by a table of 16 STEs maintained in 16 SLB entries.

A control bit in the corresponding segment descriptor then determines if the access is to memory (memory-mapped) or to a direct-store segment. Note that the direct-store interface is present to allow certain older I/O devices to use this interface. When an access is determined to be to the direct-store interface space, the implementation invokes an elaborate hardware protocol for communication with these devices. The direct-store interface protocol is not optimized for performance, and therefore, its use is discouraged. The most efficient method for accessing I/O is by memory-mapping the I/O areas.

For memory accesses translated by a segment descriptor, the interim virtual address is generated using the information in the segment descriptor. Page address translation corresponds to the conversion of this virtual address into the 64-bit (or 32-bit) physical address used by the memory subsystem. In some cases, the physical address for the page resides in an on-chip TLB and is available for quick access. However, if the page address translation misses in a TLB, the MMU searches the page table in memory (using the virtual address information and a hashing function) to locate the required physical address. Some

implementations may have dedicated hardware to perform the page table search automatically, while others may define an exception handler routine that searches the page table with software.

Block address translation occurs in parallel with page (and direct-store segment) address translation and is similar to page address translation, except that there are fewer upper-order effective address bits to be translated into physical address bits (more lower-order address bits (at least 17) are untranslated to form the offset into a block). Also, instead of segment descriptors and a page table, block address translations use the on-chip BAT registers as a BAT array. If an effective address matches the corresponding field of a BAT register, the information in the BAT register is used to generate the physical address; in this case, the results of the page translation (occurring in parallel) are ignored. Note that a matching BAT array entry takes precedence over a translation provided by the segment descriptor in all cases (even if the segment is a direct-store segment).

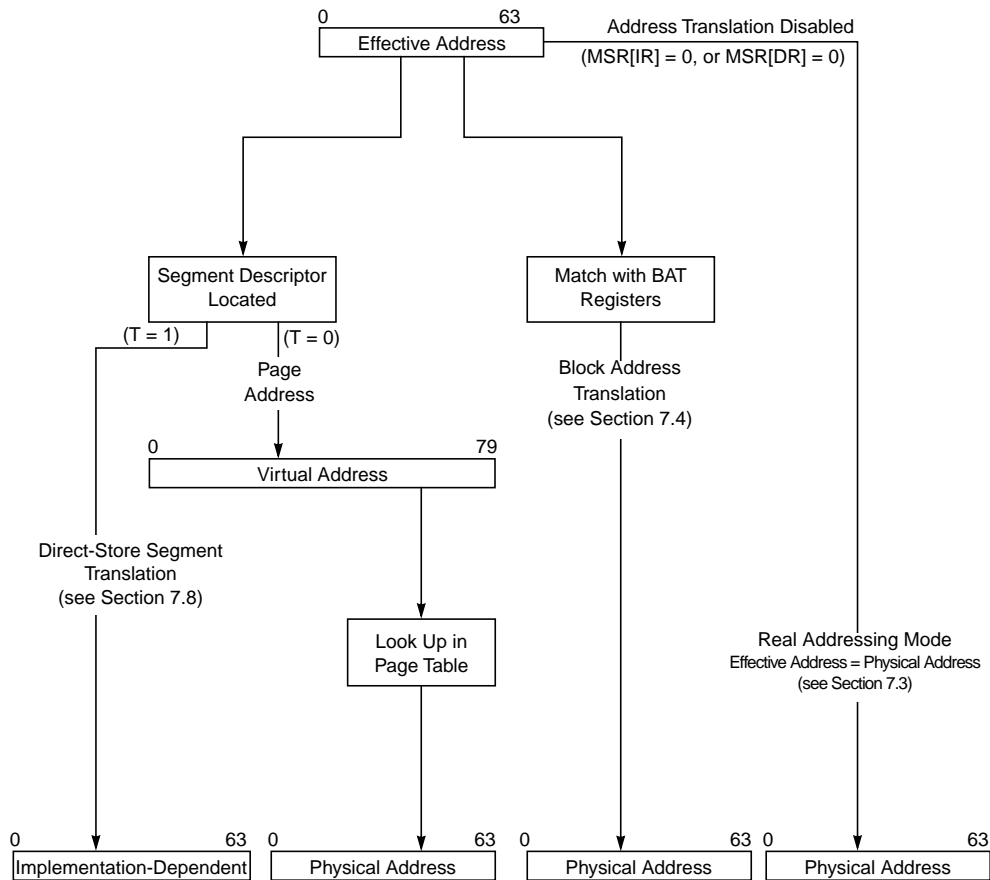

Figure 7-3. Address Translation Types—64-Bit Implementations

TEMPORARY 64-BIT BRIDGE

Note that Figure 7-3 shows address sizes for a 64-bit processor operating in 64-bit mode. If the 64-bit bridge is enabled (ASR[V] is cleared), only the 32-bit address space is available and only 52 bits of the virtual address are used. However, the bridge supports cross-memory operations that permit an operating system to establish addressability to an address space, to copy data to it from another address space, and then to destroy the new addressability, without altering the segment table. For more information, see Section 7.9.5, “Segment Register Instructions Defined Exclusively for the 64-Bit Bridge.”

Direct-store address translation is used when the optional direct-store translation control bit (T bit) in the corresponding segment descriptor is set (being phased out of the architecture). In this case, the remaining information in the segment descriptor is interpreted as identifier information that is used with the remaining effective address bits to generate the protocol used in a direct-store interface access on the external interface; additionally, no TLB lookup or page table search is performed.

Real addressing mode address translation occurs when address translation is disabled; in this case, the physical address generated is identical to the effective address. Instruction and data address translation is enabled with the MSR[IR] and MSR[DR] bits, respectively. Thus, when the processor generates an access, and the corresponding address translation enable bit in MSR (MSR[IR] for instruction accesses and MSR[DR] for data accesses) is cleared, the resulting physical address is identical to the effective address and all other translation mechanisms are ignored. See Section 7.2.6.1, “Real Addressing Mode and Block Address Translation Selection,” for more information.

7.2.4 Memory Protection Facilities

In addition to the translation of effective addresses to physical addresses, the MMU provides access protection of supervisor areas from user access and can designate areas of memory as read-only as well as no-execute. Table 7-4 shows the eight protection options supported by the MMU for pages.

Table 7-4. Access Protection Options for Pages

Option	User Read		User Write	Supervisor Read		Supervisor Write
	I-Fetch	Data		I-Fetch	Data	
Supervisor-only	—	—	—	√	√	√
Supervisor-only-no-execute	—	—	—	—	√	√
Supervisor-write-only	√	√	—	√	√	√
Supervisor-write-only-no-execute	—	√	—	—	√	√
Both user/supervisor	√	√	√	√	√	√
Both user/supervisor-no-execute	—	√	√	—	√	√
Both read-only	√	√	—	√	√	—
Both read-only-no-execute	—	√	—	—	√	—

√ Access permitted
 — Protection violation

The operating system programs whether or not instruction fetches are allowed from an area of memory with the no-execute option provided in the segment descriptor. Each of the remaining options is enforced based on a combination of information in the segment descriptor and the page table entry. Thus, the supervisor-only option allows only read and write operations generated while the processor is operating in supervisor mode (corresponding to MSR[PR] = 0) to access the page. User accesses that map into a supervisor-only page cause an exception to be taken.

Note that independently of the protection mechanisms, care must be taken when writing to instruction areas as coherency must be maintained with on-chip copies of instructions that may have been prefetched into a queue or an instruction cache. Refer to Section 5.1.5.2, “Instruction Cache Instructions,” for more information on coherency within instruction areas.

As shown in the table, the supervisor-write-only option allows both user and supervisor accesses to read from the page, but only supervisor programs can write to that area. There is also an option that allows both supervisor and user programs read and write access (both user/supervisor option), and finally, there is an option to designate a page as read-only, both for user and supervisor programs (both read-only option).

For areas of memory that are translated by the block address translation mechanism, the protection options are similar, except that blocks are translated by separate mechanisms for instruction and data, blocks do not have a no-execute option, and blocks can be designated as enabled for user and supervisor accesses independently. Therefore, a block can be designated as supervisor-only, for example, but this block can be programmed such that all user accesses simply ignore the block translation, rather than take an exception in the case of a match. This allows a flexible way for supervisor and user programs to use overlapping effective address space areas that map to unique physical address areas (without exceptions occurring).

For direct-store segments, the MMU calculates a key bit based on the protection values programmed in the segment descriptor and the specific user/supervisor and read/write information for the particular access. However, this bit is merely passed on to the system interface to be transmitted in the context of the direct-store interface protocol. The MMU does not itself enforce any protection or cause any exception based on the state of the key bit for these accesses. The I/O controller device or other external hardware can optionally use this bit to enforce any protection required. Note that the direct-store facility is being phased out of the architecture and future devices are not likely to implement it.

Finally, a facility defined in the VEA and OEA allows pages or blocks to be designated as guarded, preventing out-of-order accesses that may cause undesired side effects. For example, areas of the memory map that are used to control I/O devices can be marked as guarded so that accesses (for example, instruction prefetches) do not occur unless they are explicitly required by the program. Refer to Section 5.2.1.5.3, “Out-of-Order Accesses to Guarded Memory,” for a complete description of how accesses to guarded memory are restricted.

7.2.5 Page History Information

The MMU of PowerPC processors also defines referenced (R) and changed (C) bits in the page address translation mechanism that can be used as history information relevant to the virtual page. This information can then be used by the operating system to determine which areas of memory to write back to disk when new pages must be allocated in main memory. While these bits are initially programmed by the operating system into the page table, the architecture specifies that the R and C bits are maintained by the processor and the processor updates these bits when required.

7.2.6 General Flow of MMU Address Translation

The following sections describe the general flow used by PowerPC processors to translate effective addresses to virtual and then physical addresses. Note that although there are references to the concept of an on-chip TLB and SLB, these entities may not be present in a particular hardware implementation for performance enhancement (and a particular implementation may have one or more TLBs and SLBs). Thus, they are shown here as optional and only the software ramifications of the existence of a TLB or SLB are discussed.

7.2.6.1 Real Addressing Mode and Block Address Translation Selection

When an instruction or data access is generated and the corresponding instruction or data translation is disabled ($MSR[IR] = 0$ or $MSR[DR] = 0$), real addressing mode translation is used (physical address equals effective address) and the access continues to the memory subsystem as described in Section 7.3, “Real Addressing Mode.”

Figure 7-4 shows the flow used by the MMU in determining whether to select real addressing mode or block address translation or to use the segment descriptor to select either direct-store or page address translation.

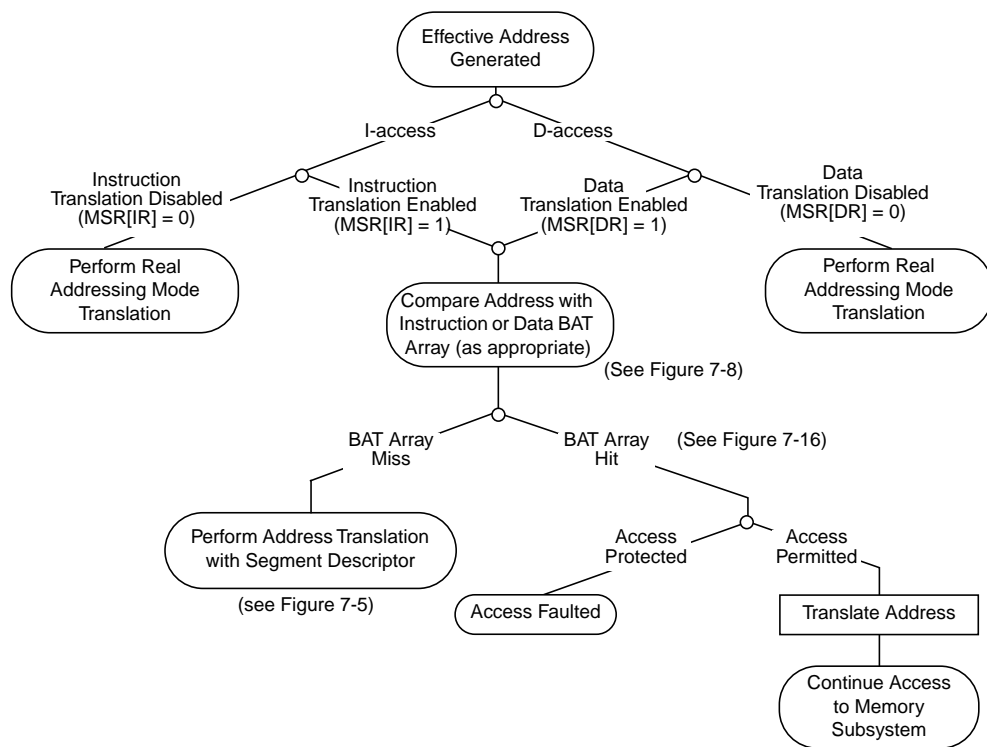
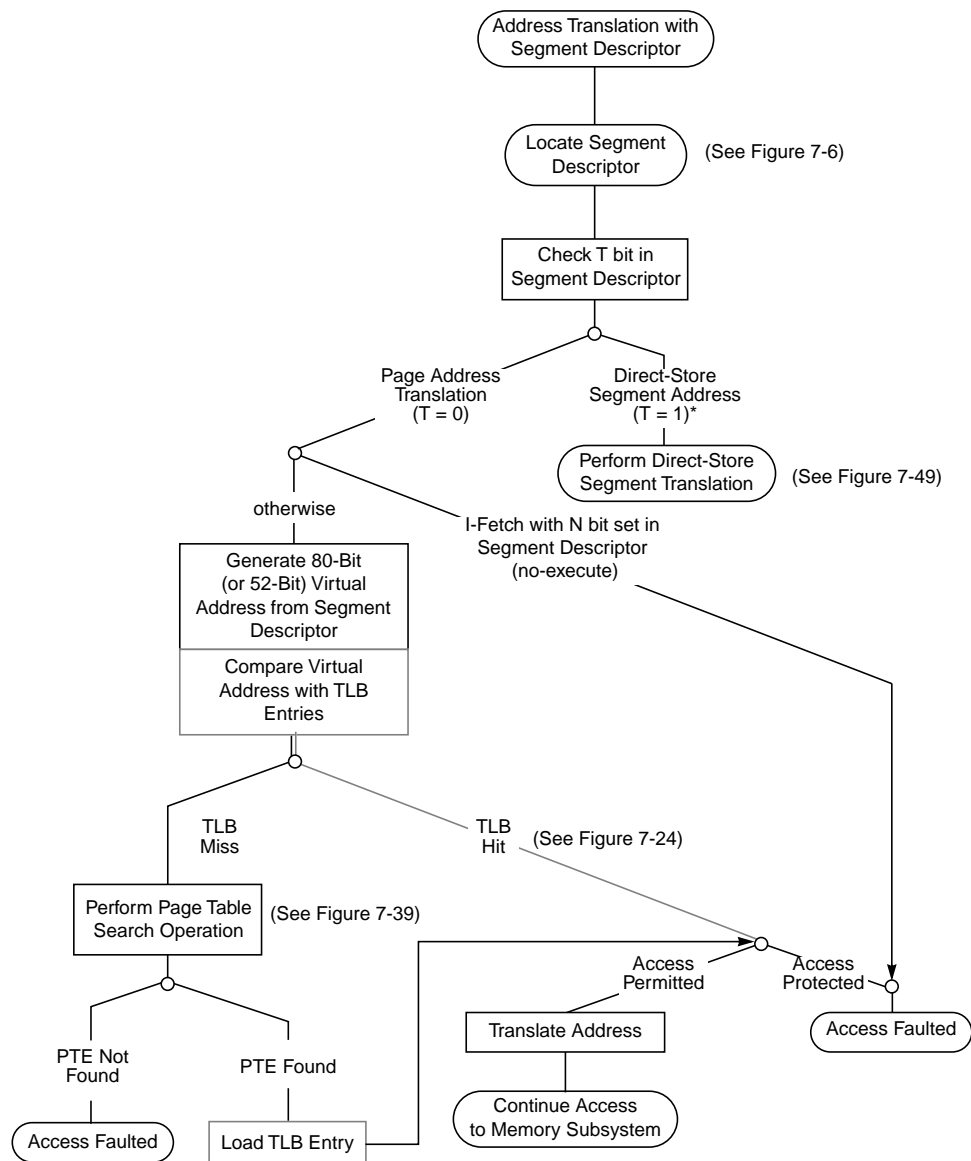

Figure 7-4. General Flow of Address Translation (Real Addressing Mode and Block)

Note that if the BAT array search results in a hit, the access is qualified with the appropriate protection bits. If the access is determined to be protected (not allowed), an exception (ISI or DSI exception) is generated.

7.2.6.2 Page and Direct-Store Address Translation Selection

If address translation is enabled (real addressing mode translation not selected) and the effective address information does not match with a BAT array entry, then the segment descriptor must be located. Once the segment descriptor is located, the T bit in the segment descriptor selects whether the translation is to a page or to a direct-store segment as shown in Figure 7-5. In addition, Figure 7-5 also shows the way in which the no-execute protection is enforced; if the N bit in the segment descriptor is set and the access is an instruction fetch, the access is faulted.



Notes:
 * Not allowed for instruction accesses (causes ISI exception)
 — Implementation-specific

Figure 7-5. General Flow of Page and Direct-Store Address Translation

The segment descriptor is contained in different constructs for 64- and 32-bit implementations as shown in Figure 7-6. For 64-bit implementations, the segment descriptor for each access is located in an STE that resides in a segment table in memory. The base address of this segment table is specified in the address space register (ASR) and the entries of the table are located by using a hashing function. Although it is not architecturally required, hardware implementations may have one or more on-chip SLBs that keep recently-used STEs for quick access.

For 32-bit implementations, the segment descriptor for an access is contained in one of 16 on-chip segment registers; effective address bits EA0–EA3 select one of the 16 segment registers.

TEMPORARY 64-BIT BRIDGE

Processors that implement the 64-bit bridge maintain segment descriptors on-chip by emulating segment tables in 16 SLB entries. As shown in Figure 7-6, this feature is enabled by clearing the optional ASR[V] bit. This indicates that any value in the STABORG is invalid and that segment table hashing is not implemented.

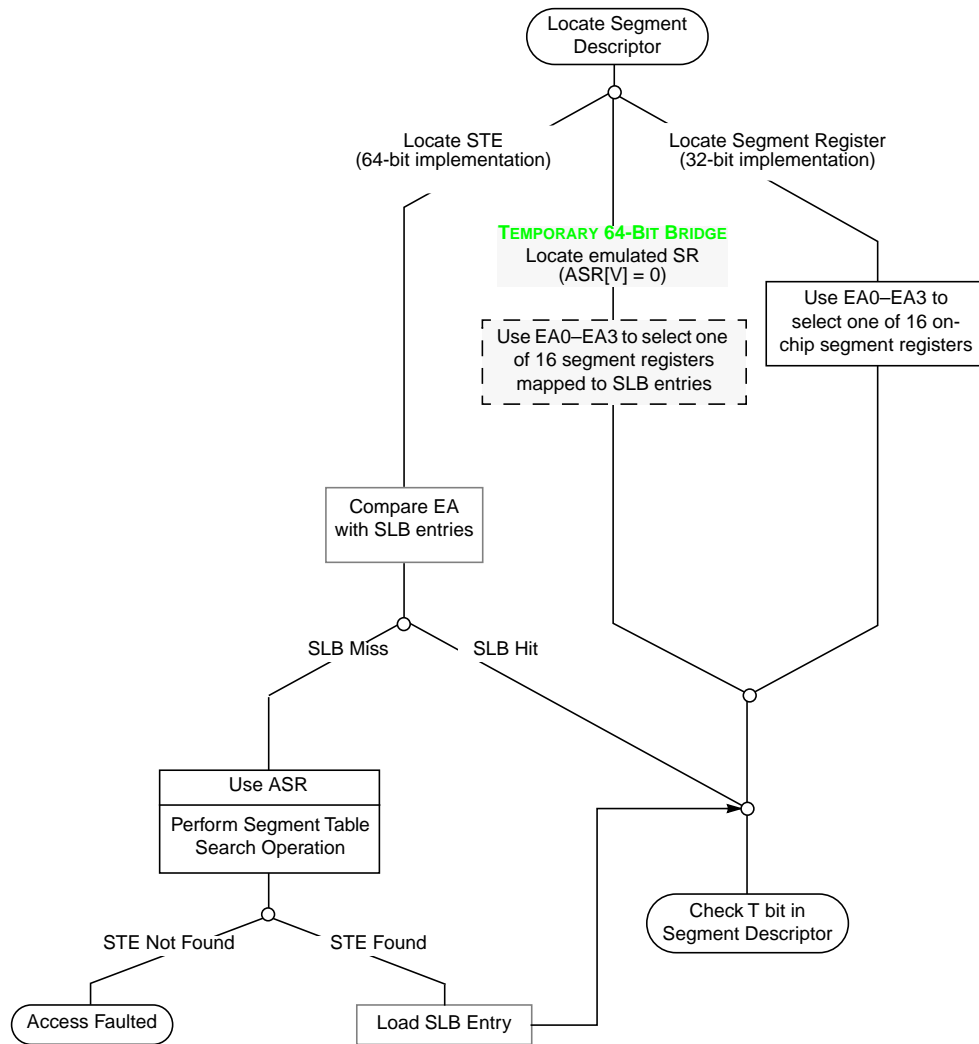

Note: — Implementation-specific

Figure 7-6. Location of Segment Descriptors

7.2.6.2.1 Selection of Page Address Translation

If the T bit in the corresponding segment descriptor is 0, page address translation is selected. The information in the segment descriptor is then used to generate the 80-bit (or 52-bit) virtual address. The virtual address is then used to identify the page address translation information (stored as page table entries (PTEs) in a page table in memory). Once again, although the architecture does not require the existence of a TLB, one or more

TLBs may be implemented in the hardware to store copies of recently-used PTEs on-chip for increased performance.

If an access hits in the TLB, the page translation occurs and the physical address bits are forwarded to the memory subsystem. If the translation is not found in the TLB, the MMU requires a search of the page table. The hardware of some implementations may perform the table search automatically, while others may trap to an exception handler for the system software to perform the page table search. If the translation is found, a new TLB entry is created and the page translation is once again attempted. This time, the TLB is guaranteed to hit. Once the PTE is located, the access is qualified with the appropriate protection bits. If the access is determined to be protected (not allowed), an exception (ISI or DSI exception) is generated.

If the PTE is not found by the table search operation, an ISI or DSI exception is generated.

7.2.6.2.2 Selection of Direct-Store Address Translation

When the segment descriptor has the T bit set, the access is considered a direct-store access and the direct-store interface protocol of the external interface is used to perform the access. The selection of address translation type differs for instruction and data accesses only in that instruction accesses are not allowed from direct-store segments; attempting to fetch an instruction from a direct-store segment causes an ISI exception.

Note that this facility is not optimized for performance, was present for compatibility with POWER devices, and is being phased out of the architecture. Future devices are not likely to support it; software should not depend on its effects and new software should not use it. See Section 7.8, “Direct-Store Segment Address Translation,” for more detailed information about the translation of addresses in direct-store segments in those processors that implement this.

7.2.7 MMU Exceptions Summary

In order to complete any memory access, the effective address must be translated to a physical address. A translation exception condition occurs if this translation fails for one of the following reasons:

- There is no valid entry in the page table for the page specified by the effective address (and segment descriptor) and there is no valid BAT translation.
- There is no valid segment descriptor and there is no valid BAT translation.
- An address translation is found but the access is not allowed by the memory protection mechanism.

The translation exception conditions cause either the ISI or the DSI exception to be taken as shown in Table 7-5. The state saved by the processor for each of these exceptions contains information that identifies the address of the failing instruction. Refer to Chapter 6, “Exceptions,” for a more detailed description of exception processing, and the bit settings of SRR1 and DSISR when an exception occurs. Note that the bit settings shown for the SRR1 register are shown for 64-bit implementations. Since the SRR1 register is a 32-bit register in 32-bit implementations, the value 32 must be subtracted from the bit numbers shown for SRR1 in these cases.

Table 7-5. Translation Exception Conditions

Condition	Description	Exception
Page fault (no PTE found)	No matching PTE found in page tables (and no matching BAT array entry)	I access: ISI exception SRR1[1] = 1 (32 bit) SRR1[33] = 1 (64 bit)
		D access: DSI exception DSISR[1] = 1
Segment fault (no STE found)	No matching STE found in the segment tables (for 64-bit implementations) and no matching BAT array entry	I access: ISI exception SRR1[42] = 1
		D access: DSI exception DSISR[10] = 1
Block protection violation	Conditions described in Table 7-12 for block	I access: ISI exception SRR1[4] = 1 (32 bit) SRR1[36] = 1 (64 bit)
		D access: DSI exception DSISR[4] = 1
Page protection violation	Conditions described in Table 7-22 for page	I access: ISI exception SRR1[4] = 1 (32 bit) SRR1[36] = 1 (64 bit)
		D access: DSI exception DSISR[4] = 1
No-execute protection violation	Attempt to fetch instruction when SR[N] = 1 or STE[N] = 1	ISI exception SRR1[3] = 1 (32 bit) SRR1[35] = 1 (64 bit)
Instruction fetch from direct-store segment—note that the direct-store facility is optional and being phased out of the architecture.	Attempt to fetch instruction when SR[T] = 1 or STE[T] = 1	ISI exception SRR1[3] = 1 (32 bit) SRR1[35] = 1 (64 bit)
Instruction fetch from guarded memory	Attempt to fetch instruction when MSR[IR] = 1 and either: matching xBAT[G] = 1, or no matching BAT entry and PTE[G] = 1	ISI exception SRR1[3] = 1 (32 bit) SRR1[35] = 1 (64 bit)

In addition to the translation exceptions, there are other MMU-related conditions (some of them implementation-specific) that can cause an exception to occur. These conditions map to the exceptions as shown in Table 7-6. The only MMU exception conditions that occur when MSR[DR] = 0 are the conditions that cause the alignment exception for data accesses.

For more detailed information about the conditions that cause the alignment exception (in particular for string/multiple instructions), see Section 6.4.6, “Alignment Exception (0x00600).” Refer to Chapter 6, “Exceptions,” for a complete description of the SRR1 and DSISR bit settings for these exceptions.

Table 7-6. Other MMU Exception Conditions

Condition	Description	Exception
dcbz with $W = 1$ or $I = 1$ (may cause exception or operation may be performed to memory)	dcbz instruction to write-through or cache-inhibited segment or block	Alignment exception (implementation-dependent)
ldarx , stdcx. , lwarx , or stwcx. with $W = 1$ (may cause exception or execute correctly)	Reservation instruction to write-through segment or block	DSI exception (implementation-dependent) DSISR[5] = 1
ldarx , stdcx. , lwarx , stwcx. , eciwX , or ecowX instruction to direct-store segment (may cause exception or may produce boundedly-undefined results)—note that the direct-store facility is optional and being phased out of the architecture	Reservation instruction or external control instruction when $SR[T] = 1$ or $STE[T] = 1$	DSI exception (implementation-dependent) DSISR[5] = 1
Floating-point load or store to direct-store segment (may cause exception or instruction may execute correctly)—note that the direct-store facility is optional and being phased out of the architecture	Floating-point memory access when $SR[T] = 1$ or $STE[T] = 1$	Alignment exception (implementation-dependent)
Load or store operation that causes a direct-store error—note that the direct-store facility is optional and being phased out of the architecture	Direct-store interface protocol signalled with an error condition	DSI exception DSISR[0] = 1
eciwX or ecowX attempted when external control facility disabled	eciwX or ecowX attempted with $EAR[E] = 0$	DSI exception DSISR[11] = 1
lmw , stmw , lswi , lswx , stswi , or stswx instruction attempted in little-endian mode	lmw , stmw , lswi , lswx , stswi , or stswx instruction attempted while $MSR[LE] = 1$	Alignment exception
Operand misalignment	Translation enabled and operand is misaligned as described in Chapter 6, “Exceptions.”	Alignment exception (some of these cases are implementation-dependent)

7.2.8 MMU Instructions and Register Summary

The MMU instructions and registers provide the operating system with the ability to set up the segment descriptors. Additionally, the operating system has the resources to set up the block address translation areas and the page tables in memory.

Note that because the implementation of TLBs and SLBs is optional, the instructions that refer to these structures are also optional. However, as these structures serve as caches of the page table (and segment table, in the case of an SLB), there must be a software protocol for maintaining coherency between these caches and the tables in memory whenever changes are made to the tables in memory. Therefore, the PowerPC OEA specifies that a processor implementing a TLB is guaranteed to have a means for doing the following:

- Invalidating an individual TLB entry
- Invalidating the entire TLB

Similarly, a processor that implements an SLB is guaranteed to have a means for doing the following:

- Invalidating an individual SLB entry (the architecture defines an optional **slbie** instruction for this purpose)
- Invalidating the entire SLB (the architecture defines an optional **slbia** instruction for this purpose)

TEMPORARY 64-BIT BRIDGE

Note that while the implementation of SLBs in 64-bit processors is optional, processors that implement the 64-bit bridge are required to implement at least 16 SLB entries to provide a means of emulating the segment registers as they are defined in the 32-bit architecture. When the processor is using the 64-bit bridge, neither the **slbie** or **slbia** instruction should be executed.

When the tables in memory are changed, the operating system purges these caches of the corresponding entries, allowing the translation caching mechanism to refetch from the tables when the corresponding entries are required.

A processor may implement one or more of the instructions described in this section to support table invalidation. Alternatively, an algorithm may be specified that performs one of the functions listed above (a loop invalidating individual TLB entries may be used to invalidate the entire TLB, for example), or different instructions may be provided.

A processor may also perform additional functions (not described here) as well as those described in the implementation of some of these instructions. For example, the **tlbie** instruction may be implemented so as to purge all TLB entries in a congruence class (that is, all TLB entries indexed by the specified EA which can include corresponding entries in data and instruction TLBs) or the entire TLB.

Note that if a processor does not implement an optional instruction it treats the instruction as a no-op or as an illegal instruction, depending on the implementation. Also, note that the segment register and TLB concepts described here are conceptual; that is, a processor may implement parallel sets of segment registers (and even TLBs) for instructions and data.

Because the MMU specification for PowerPC processors is so flexible, it is recommended that the software that uses these instructions and registers be encapsulated into subroutines to minimize the impact of migrating across the family of implementations.

Table 7-7 summarizes the PowerPC instructions that specifically control the MMU. For more detailed information about the instructions, refer to Chapter 8, “Instruction Set.”

Table 7-7. Instruction Summary—Control MMU

Instruction	Description
mtsr SR,rS	Move to Segment Register SR[SR]← rS 32-bit implementations and 64-bit bridge only
mtsrin rS,rB	Move to Segment Register Indirect SR[rB[0–3]]←rS 32-bit implementations and 64-bit bridge only
TEMPORARY 64-BIT BRIDGE mtsr SR,rS	Move to Segment Register Double Word SLB[SR]← rS 64-bit bridge only
mtsrin rS,rB	Move to Segment Register Indirect Double Word SLB(rB[32-35]) ← (rS) 64-bit bridge only
mfsr rD,SR	Move from Segment Register rD←SR[SR] 32-bit implementations and 64-bit bridge only
mfsrin rD,rB	Move from Segment Register Indirect rD←SR[rB[0–3]] 32-bit implementations and 64-bit bridge only
tlbia (optional)	Translation Lookaside Buffer Invalidate All For all TLB entries, TLB[V]←0 Causes invalidation of TLB entries only for processor that executed the tlbia
tlbie rB (optional)	Translation Lookaside Buffer Invalidate Entry If TLB hit (for effective address specified as rB), TLB[V]←0 Causes TLB invalidation of entry in all processors in system
tlbsync (optional)	Translation Lookaside Buffer Synchronize Ensures that all tlbie instructions previously executed by the processor executing the tlbsync instruction have completed on all processors
slbia (optional)	Segment Table Lookaside Buffer Invalidate All For all SLB entries, SLB[V]←0 64-bit implementations only
slbie rB (optional)	Segment Table Lookaside Buffer Invalidate Entry If SLB hit (for effective address specified as rB), SLB[V]←0 64-bit implementations only

Table 7-8 summarizes the registers that the operating system uses to program the MMU. These registers are accessible to supervisor-level software only (supervisor level is referred to as privileged state in the architecture specification). These registers are described in detail in Chapter 2, “PowerPC Register Set.”

Table 7-8. MMU Registers

Register	Description
Segment registers (SR0–SR15)	The sixteen 32-bit segment registers are present only in 32-bit implementations of the PowerPC architecture. Figure 7-20 shows the format of a segment register. The fields in the segment register are interpreted differently depending on the value of bit 0. The segment registers are accessed by the mtsr , mtsrin , mfsr , and mfsrin instructions.
BAT registers (IBAT0U–IBAT3U, IBAT0L–IBAT3L, DBAT0U–DBAT3U, and DBAT0L–DBAT3L)	There are 16 BAT registers, organized as four pairs of instruction BAT registers (IBAT0U–IBAT3U paired with IBAT0L–IBAT3L) and four pairs of data BAT registers (DBAT0U–DBAT3U paired with DBAT0L–DBAT3L). The BAT registers are defined as 32-bit registers in 32-bit implementations, and 64-bit registers in 64-bit implementations. These are special-purpose registers that are accessed by the mtspr and mfspr instructions.
SDR1 register	The SDR1 register specifies the base and size of the page tables in memory. SDR1 is defined as a 64-bit register for 64-bit implementations and as a 32-bit register for 32-bit implementations. This is a special-purpose register that is accessed by the mtspr and mfspr instructions.
Address space register (ASR)	The 64-bit ASR specifies the physical address in memory of the segment table for 64-bit implementations. This is a special-purpose register that is accessed by the mtspr and mfspr instructions.

7.2.9 TLB Entry Invalidation

Optionally, PowerPC processors implement TLB structures that store on-chip copies of the PTEs that are resident in physical memory. These processors have the ability to invalidate resident TLB entries through the use of the **tlbie** and **tlbia** instructions. Additionally, these instructions may also enable a TLB invalidate signalling mechanism in hardware so that other processors also invalidate their resident copies of the matching PTE. See Chapter 8, “Instruction Set,” for detailed information about the **tlbie** and **tlbia** instructions.

7.3 Real Addressing Mode

If address translation is disabled ($MSR[IR] = 0$ or $MSR[DR] = 0$) for a particular access, the effective address is treated as the physical address and is passed directly to the memory subsystem as a real addressing mode address translation. If an implementation has a smaller physical address range than effective address range, the extra high-order bits of the effective address may be ignored in the generation of the physical address.

Section 2.3.18, “Synchronization Requirements for Special Registers and for Lookaside Buffers,” describes the synchronization requirements for changes to $MSR[IR]$ and $MSR[DR]$.

The addresses for accesses that occur in real addressing mode bypass all memory protection checks as described in Section 7.4.4, “Block Memory Protection,” and Section 7.5.4, “Page Memory Protection” and do not cause the recording of referenced and changed information (described in Section 7.5.3, “Page History Recording”).

For data accesses that use real addressing mode, the memory access mode bits (WIMG) are assumed to be 0b0011. That is, the cache is write-back and memory does not need to be updated immediately ($W = 0$), caching is enabled ($I = 0$), data coherency is enforced with memory, I/O, and other processors (caches) ($M = 1$, so data is global), and the memory is guarded. For instruction accesses in real addressing mode, the memory access mode bits (WIMG) are assumed to be either 0b0001 or 0b0011. That is, caching is enabled ($I = 0$) and the memory is guarded. Additionally, coherency may or may not be enforced with memory, I/O, and other processors (caches) ($M = 0$ or 1 , so data may or may not be considered global). For a complete description of the WIMG bits, refer to Section 5.2.1, “Memory/Cache Access Attributes.”

Note that the attempted execution of the **eciwx** or **ecowx** instructions while $MSR[DR] = 0$ causes boundedly-undefined results.

Whenever an exception occurs, the processor clears both the $MSR[IR]$ and $MSR[DR]$ bits. Therefore, at least at the beginning of all exception handlers (including reset), the processor operates in real addressing mode for instruction and data accesses. If address translation is required for the exception handler code, the software must explicitly enable address translation by accessing the MSR as described in Chapter 2, “PowerPC Register Set.”

Note that an attempt to access a physical address that is not physically present in the system may cause a machine check exception (or even a checkstop condition), depending on the response by the system for this case. Thus, care must be taken when generating addresses in real addressing mode. Note that this can also occur when translation is enabled and the ASR or SDR1 registers set up the translation such that nonexistent memory is accessed. See Section 6.4.2, “Machine Check Exception (0x00200),” for more information on machine check exceptions.

TEMPORARY 64-BIT BRIDGE

Note that if $ASR[V] = 0$, a reference to a nonexistent address in the STABORG field does not cause a machine check exception.

7.4 Block Address Translation

The block address translation (BAT) mechanism in the OEA provides a way to map ranges of effective addresses larger than a single page into contiguous areas of physical memory. Such areas can be used for data that is not subject to normal virtual memory handling (paging), such as a memory-mapped display buffer or an extremely large array of numerical data.

The following sections describe the implementation of block address translation in PowerPC processors, including the block protection mechanism, followed by a block translation summary with a detailed flow diagram.

7.4.1 BAT Array Organization

The block address translation mechanism in PowerPC processors is implemented as a software-controlled BAT array. The BAT array maintains the address translation information for eight blocks of memory. The BAT array in PowerPC processors is maintained by the system software and is implemented as a set of 16 special-purpose registers (SPRs). Each block is defined by a pair of SPRs called upper and lower BAT registers that contain the effective and physical addresses for the block.

The BAT registers can be read from or written to by the **mfspr** and **mtspr** instructions; access to the BAT registers is privileged. Section 7.4.3, “BAT Register Implementation of BAT Array,” gives more information about the BAT registers. Note that the BAT array entries are completely ignored for TLB invalidate operations detected in hardware and in the execution of the **tlbie** or **tlbia** instruction.

Figure 7-7 shows the organization of the BAT array in a 64-bit implementation. Four pairs of BAT registers are provided for translating instruction addresses and four pairs of BAT registers are used for translating data addresses. These eight pairs of BAT registers comprise two four-entry fully-associative BAT arrays (each BAT array entry corresponds to a pair of BAT registers). The BAT array is fully-associative in that any address can reside in any BAT. In addition, the effective address field of all four corresponding entries (instruction or data) is simultaneously compared with the effective address of the access to check for a match.

The BAT array organization for 32-bit implementations is the same as that shown in Figure 7-7 except that the effective address field to be compared with the BEPI field (block effective page index) in the upper BAT register is EA0–EA14 instead of EA0–EA46.

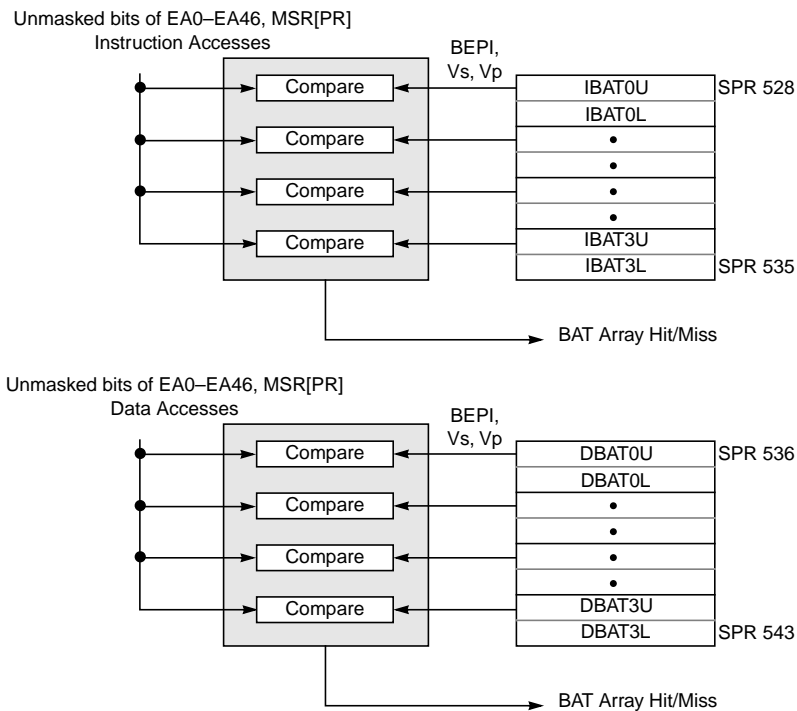

Figure 7-7. BAT Array Organization—64-Bit Implementations

Each pair of BAT registers defines the starting address of a block in the effective address space, the size of the block, and the start of the corresponding block in physical address space. If an effective address is within the range defined by a pair of BAT registers, its physical address is defined as the starting physical address of the block plus the lower-order effective address bits.

Blocks are restricted to a finite set of sizes, from 128 Kbytes (2^{17} bytes) to 256 Mbytes (2^{28} bytes). The starting address of a block in both effective address space and physical address space is defined as a multiple of the block size.

It is an error for system software to program the BAT registers such that an effective address is translated by more than one valid IBAT pair or more than one valid DBAT pair. If this occurs, the results are undefined and may include a spurious violation of the memory protection mechanism, a machine check exception, or a checkstop condition.

The equation for determining whether a BAT entry is valid for a particular access is as follows:

$$\text{BAT_entry_valid} = (Vs \ \& \ \neg\text{MSR}[\text{PR}]) \ | \ (Vp \ \& \ \text{MSR}[\text{PR}])$$

If a BAT entry is not valid for a given access, it does not participate in address translation for that access. Two BAT entries may not map an overlapping effective address range and be valid at the same time.

Entries that have complementary settings of $V[s]$ and $V[p]$ may map overlapping effective address blocks. Complementary settings would be as follows:

BAT entry A: $V_s = 1, V_p = 0$

BAT entry B: $V_s = 0, V_p = 1$

7.4.2 Recognition of Addresses in BAT Arrays

The BAT arrays are accessed in parallel with segmented address translation to determine whether a particular effective address corresponds to a block defined by the BAT arrays. If an effective address is within a valid BAT area, the physical address for the memory access is determined as described in Section 7.4.5, “Block Physical Address Generation.”

Block address translation is enabled only when address translation is enabled ($MSR[IR] = 1$ and/or $MSR[DR] = 1$). Also, a matching BAT array entry always takes precedence over any segment descriptor translation, independent of the setting of the $STE[T]$ (or $SR[T]$) bit, and the segment descriptor information is completely ignored.

Figure 7-8 shows the flow of the BAT array comparison used in block address translation for 64-bit implementations. When an instruction fetch operation is required, the effective address is compared with the four instruction BAT array entries; similarly, the effective addresses of data accesses are compared with the four data BAT array entries. The BAT arrays are fully-associative in that any of the four instruction or data BAT array entries can contain a matching entry (for an instruction or data access, respectively).

Note that Figure 7-8 assumes that the protection bits, $BATL[PP]$, allow an access to occur. If not, an exception is generated, as described in Section 7.4.4, “Block Memory Protection.”

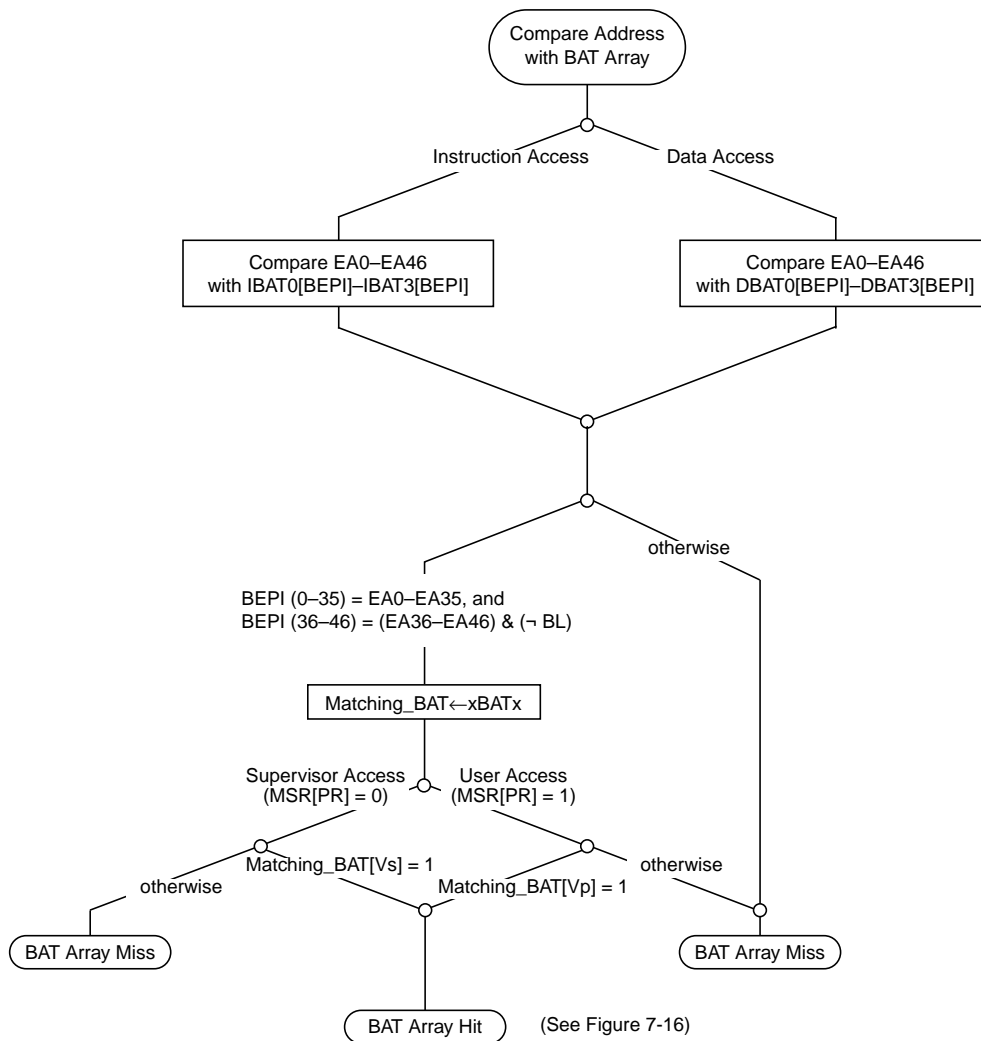

Figure 7-8. BAT Array Hit/Miss Flow—64-Bit Implementations

Two BAT array entry fields are compared to determine if there is a BAT array hit—a block effective page index (BEPI) field, which is compared with the high-order effective address bits, and one of two valid bits (Vs or Vp), which is evaluated relative to the value of MSR[PR]. Note that the figure assumes a block size of 128 Kbytes (all bits of BEPI are used in the comparison); the actual number of bits of the BEPI field that are used are masked by the BL field (block length) as described in Section 7.4.3, “BAT Register Implementation of

BAT Array.” Also, note that the flow for 32-bit implementations is the same as that shown in Figure 7-8 except that the effective address field to be compared with the BEPI field is EA0–EA14 instead of EA0–EA46.

Thus, the specific criteria for determining a BAT array hit are as follows:

- The upper-order 47 bits (or 15 bits for 32-bit implementations) of the effective address, subject to a mask, must match the BEPI field of the BAT array entry.
- The appropriate valid bit in the BAT array entry must set to one as follows:
 - MSR[PR] = 0 corresponds to supervisor mode; in this mode, Vs is checked.
 - MSR[PR] = 1 corresponds to user mode; in this mode, Vp is checked.

The matching entry is then subject to the protection checking described in Section 7.4.4, “Block Memory Protection,” before it is used as the source for the physical address. Note that if a user mode program performs an access with an effective address that matches the BEPI field of a BAT area defined as valid only for supervisor accesses (Vp = 0 and Vs = 1) for example, the BAT mechanism does not generate a protection violation and the BAT entry is simply ignored. Thus, a supervisor program can use the block address translation mechanism to share a portion of the effective address space with a user program (that uses page address translation for this area).

If a memory area is to be mapped by the BAT mechanism for both instruction and data accesses, the mapping must be set up in both an IBAT and DBAT entry; this is the case even on implementations that do not have separate instruction and data caches.

Note that a block can be defined to overlay part of a segment such that the block portion is nonpaged although the rest of the segment can be paged. This allows nonpaged areas to be specified within a segment. Thus, if an area of memory is translated by an instruction BAT entry and data accesses are not also required to that same area of memory, PTEs are not required for that area of memory. Similarly, if an area of memory is translated by a data BAT entry, and instruction accesses are not also required to that same area of memory, PTEs are not required for that area of memory.

7.4.3 BAT Register Implementation of BAT Array

Recall that the BAT array is comprised of four entries used for instruction accesses and four entries used for data accesses. Each BAT array entry consists of a pair of BAT registers—an upper and a lower BAT register for each entry. The BAT registers are accessed with the **mtspr** and **mfspr** instructions and are only accessible to supervisor-level programs. See Appendix F, “Simplified Mnemonics,” for a list of simplified mnemonics for use with the BAT registers. (Note that simplified mnemonics are referred to as extended mnemonics in the architecture specification.)

Table 7-9 describes the bits in the upper and lower BAT registers for 64-bit implementations. Note that the W and G bits are defined for BAT registers that translate data accesses (DBAT registers); attempting to write to the W and G bits in IBAT registers causes boundedly-undefined results. The bit definitions for 32-bit implementations are the same except that the bit numbers from Figure 7-11 and Figure 7-12 should be substituted.

Table 7-9. BAT Registers—Field and Bit Descriptions for 64-Bit Implementations

Upper/ Lower BAT	Bits		Name	Description
	64 Bit	32 Bit		
Upper BAT Register	0–46	0–14	BEPI	Block effective page index. This field is compared with high-order bits of the effective address to determine if there is a hit in that BAT array entry.
	47–50	15–18	—	Reserved
	51–61	19–29	BL	Block length. BL is a mask that encodes the size of the block. Values for this field are listed in Table 2-12.
	62	30	Vs	Supervisor mode valid bit. This bit interacts with MSR[PR] to determine if there is a match with the logical address. For more information, see Section 7.4.2, “Recognition of Addresses in BAT Arrays.”
	63	31	Vp	User mode valid bit. This bit also interacts with MSR[PR] to determine if there is a match with the logical address. For more information, see Section 7.4.2, “Recognition of Addresses in BAT Arrays.”
Lower BAT Register	0–46	0–14	BRPN	This field is used in conjunction with the BL field to generate high-order bits of the physical address of the block.
	47–56	15–24	—	Reserved
	57–60	25–28	WIMG	Memory/cache access mode bits W Write-through I Caching-inhibited M Memory coherence G Guarded Attempting to write to the W and G bits in IBAT registers causes boundedly-undefined results. For detailed information about the WIMG bits, see Section 5.2.1, “Memory/Cache Access Attributes.”
	61	29	—	Reserved
	62–63	30–31	PP	Protection bits for block. This field determines the protection for the block as described in Section 7.4.4, “Block Memory Protection.”

The BL field in the upper BAT register is a mask that encodes the size of the block. Table 7-10 defines the bit encodings for the BL field of the upper BAT register.

Table 7-10. Upper BAT Register Block Size Mask Encodings

Block Size	BL Encoding
128 Kbytes	000 0000 0000
256 Kbytes	000 0000 0001
512 Kbytes	000 0000 0011
1 Mbyte	000 0000 0111
2 Mbytes	000 0000 1111
4 Mbytes	000 0001 1111
8 Mbytes	000 0011 1111
16 Mbytes	000 0111 1111
32 Mbytes	000 1111 1111
64 Mbytes	001 1111 1111
128 Mbytes	011 1111 1111
256 Mbytes	111 1111 1111

Only the values shown in Table 7-10 are valid for BL. An effective address is determined to be within a BAT area if the appropriate bits (determined by the BL field) of the effective address match the value in the BEPI field of the upper BAT register, and if the appropriate valid bit (Vs or Vp) is set. Note that for an access to occur, the protection bits (PP bits) in the lower BAT register must be set appropriately, as described in Section 7.4.4, “Block Memory Protection.”

The number of zeros in the BL field determines the bits of the effective address that are used in the comparison with the BEPI field to determine if there is a hit in that BAT array entry. The rightmost bit of the BL field is aligned with bit 46 (or bit 14 for 32-bit implementations) of the effective address; bits of the effective address corresponding to ones in the BL field are then cleared to zero for the comparison. For 64-bit implementations operating in 32-bit mode, the highest-order 32 bits of the effective address (EA0–EA31) are treated as zeros.

The value loaded into the BL field determines both the size of the block and the alignment of the block in both effective address space and physical address space. The values loaded into the BEPI and BRPN fields must have at least as many low-order zeros as there are ones in BL. Otherwise, the results are undefined. Also, if the processor does not support 64 bits (or 32 bits, for 32-bit implementations) of physical address, software should write zeros to those unsupported bits in the BRPN field (as the implementation treats them as reserved). Otherwise, a machine check exception can occur.

7.4.4 Block Memory Protection

After an effective address is determined to be within a block defined by the BAT array, the access is validated by the memory protection mechanism. If this protection mechanism prohibits the access, a block protection violation exception condition (DSI or ISI exception) is generated.

The memory protection mechanism allows selectively granting read access, granting read/write access, and prohibiting access to areas of memory based on a number of control criteria. The block protection mechanism provides protection at the granularity defined by the block size (128 Kbyte to 256 Mbyte).

As the memory protection mechanism used by the block and page address translation is different, refer to Section 7.5.4, “Page Memory Protection,” for specific information unique to page address translation.

For block address translation, the memory protection mechanism is controlled by the PP bits (which are located in the lower BAT register), which define the access options for the block. Table 7-11 shows the types of accesses that are allowed for the possible PP bit combinations.

Table 7-11. Access Protection Control for Blocks

PP	Accesses Allowed
00	No access
x1	Read only
10	Read/write

Thus, any access attempted (read or write) when PP = 00 results in a protection violation exception condition. When PP = x1, an attempt to perform a write access causes a protection violation exception condition, and when PP = 10, all accesses are allowed. When the memory protection mechanism prohibits a reference, one of the following occurs, depending on the type of access that was attempted:

- For data accesses, a DSI exception is generated and bit 4 of DSISR is set.
- For instruction accesses, an ISI exception is generated and bit 36 of SRR1 (bit 4 in 32-bit implementations) is set.

See Chapter 6, “Exceptions,” for more information about these exceptions.

Table 7-12 shows a summary of the conditions that cause exceptions for supervisor and user read and write accesses within a BAT area. Each BAT array entry is programmed to be either used or ignored for supervisor and user accesses via the BAT array entry valid bits, and the PP bits enforce the read/write protection options. Note that the valid bits (Vs and Vp) are used as part of the match criteria for a BAT array entry and are not explicitly part of the protection mechanism.

Table 7-12. Access Protection Summary for BAT Array

Vs	Vp	PP Field	Block Type	User Read	User Write	Supervisor Read	Supervisor Write
0	0	xx	No BAT array match	Not used	Not used	Not used	Not used
0	1	00	User—no access	Exception	Exception	Not used	Not used
0	1	x1	User-read-only	√	Exception	Not used	Not used
0	1	10	User read/write	√	√	Not used	Not used
1	0	00	Supervisor—no access	Not used	Not used	Exception	Exception
1	0	x1	Supervisor-read-only	Not used	Not used	√	Exception
1	0	10	Supervisor read/write	Not used	Not used	√	√
1	1	00	Both—no access	Exception	Exception	Exception	Exception
1	1	x1	Both-read-only	√	Exception	√	Exception
1	1	10	Both read/write	√	√	√	√

Note: The term 'Not used' implies that the access is not translated by the BAT array and is translated by the page address translation mechanism described in Section 7.5, "Memory Segment Model," instead.

Note that because access to the BAT registers is privileged, only supervisor programs can modify the protection and valid bits for the block.

Figure 7-13 expands on the actions taken by the processor in the case of a memory protection violation. Note that the **dcbt** and **dcbtst** instructions do not cause exceptions; in the case of a memory protection violation for the attempted execution of one of these instructions, the translation is aborted and the instruction executes as a no-op (no violation is reported). Refer to Chapter 6, “Exceptions,” for a complete description of the SRR1 and DSISR bit settings for the protection violation exceptions.

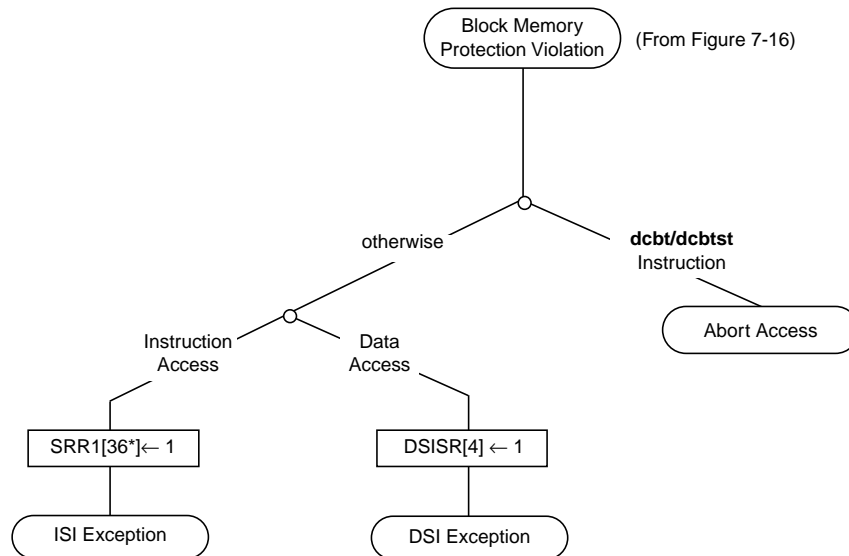

Note: *Subtract 32 from bit number for bit setting in 32-bit implementations.

Figure 7-13. Memory Protection Violation Flow for Blocks

7.4.5 Block Physical Address Generation

If the block protection mechanism validates the access, a physical address is formed as shown in Figure 7-14 for 64-bit implementations. Bits in the effective address corresponding to ones in the BL field, concatenated with the 17 lower-order bits of the effective address, form the offset within the block of memory defined by the BAT array entry. Bits in the effective address corresponding to zeros in the BL field are then logically ORed with the corresponding bits in the BRPN field to form the next higher-order bits of the physical address. Finally, the highest-order 36 bits of the BRPN field form bits 0–35 of the physical address (PA0–PA35).

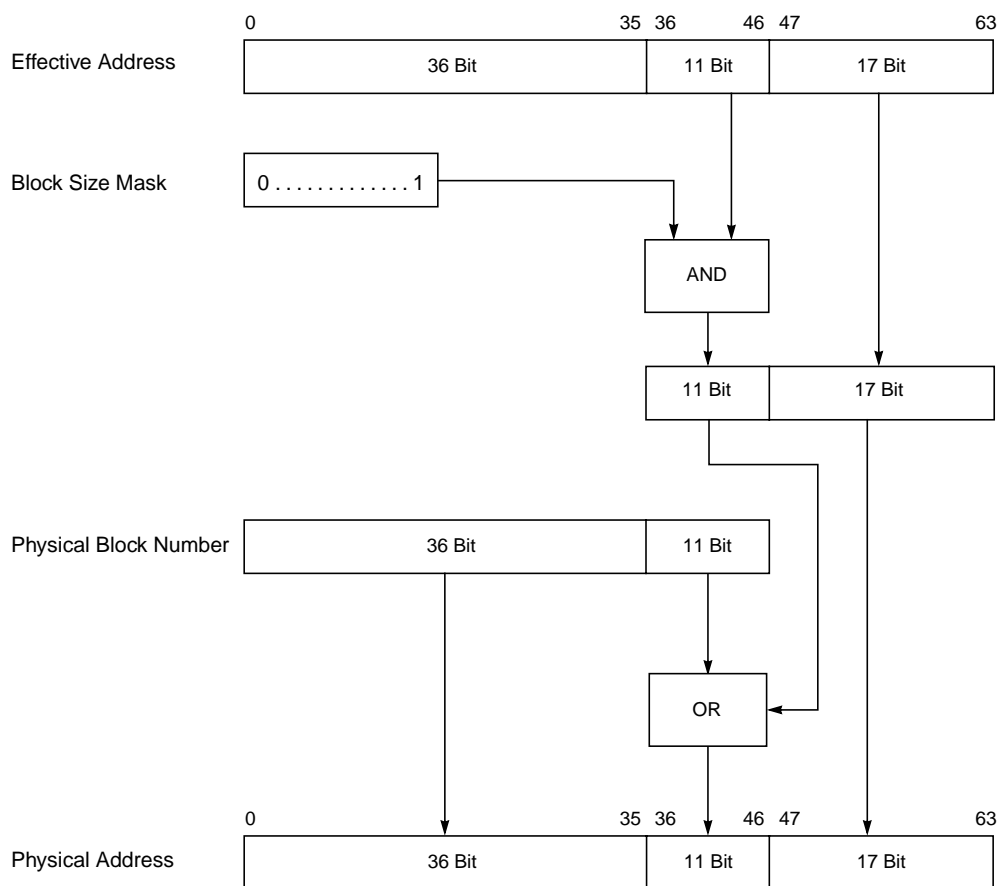

Figure 7-14. Block Physical Address Generation—64-Bit Implementations

The formation of physical addresses for 32-bit implementations is shown in Figure 7-15. In this case the highest-order four bits of the BRPN field form bits 0–3 of the physical address (PA0–PA3).

Access to the physical memory within the block is made according to the memory/cache access mode defined by the WIMG bits in the lower BAT register. These bits apply to the entire block rather than to an individual page as described in Section 5.2.1, “Memory/Cache Access Attributes.”

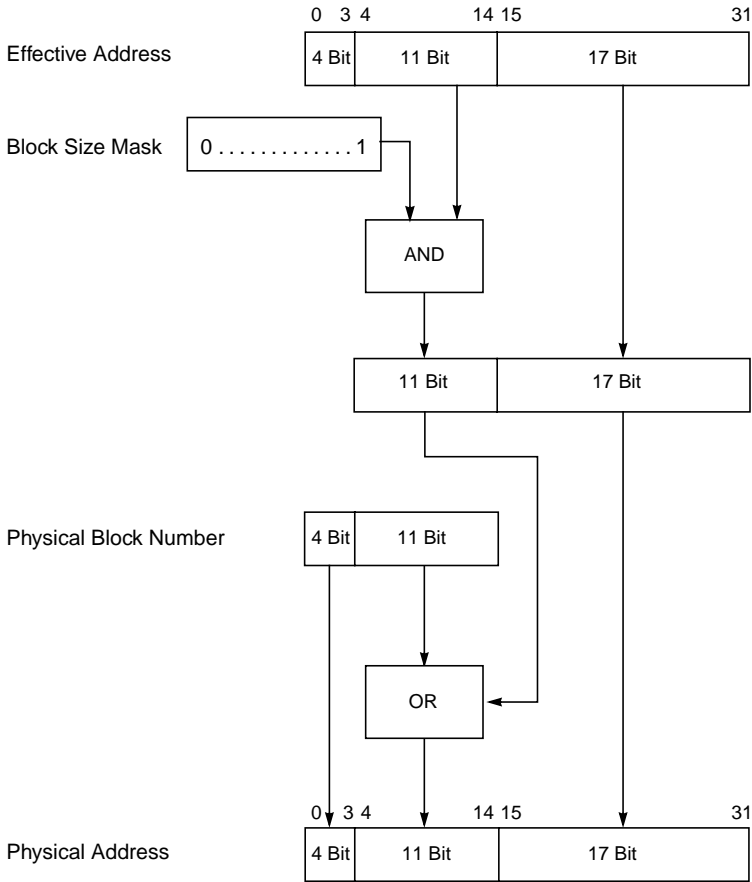

Figure 7-15. Block Physical Address Generation—32-Bit Implementations

7.4.6 Block Address Translation Summary

Figure 7-16 is an expansion of the ‘BAT Array Hit’ branch of Figure 7-4 and shows the translation of address bits for 64-bit implementations. Note that the figure does not show when many of the exceptions in Table 7-6 are detected or taken as this is implementation-specific.

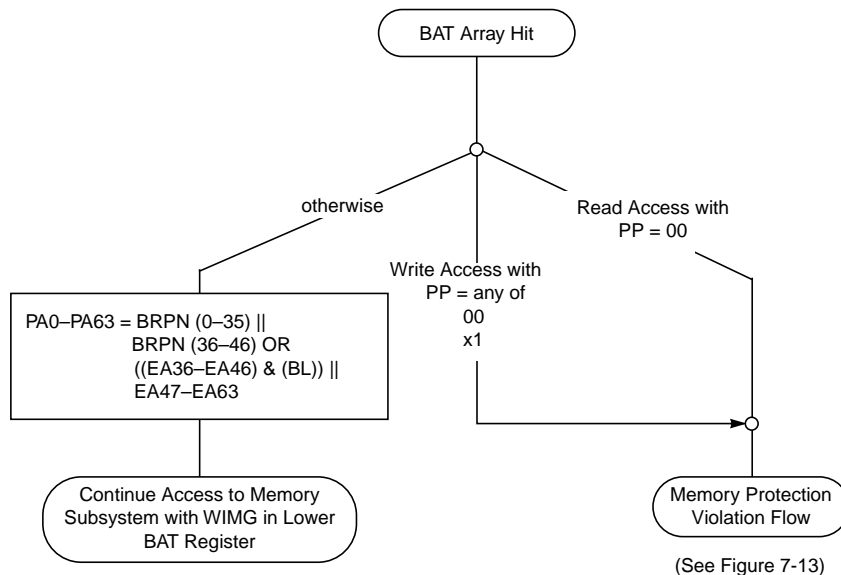

Figure 7-16. Block Address Translation Flow—64-Bit Implementations

7.5 Memory Segment Model

Memory in the PowerPC OEA is divided into 256-Mbyte segments. This segmented memory model provides a way to map 4-Kbyte pages of effective addresses to 4-Kbyte pages in physical memory (page address translation), while providing the programming flexibility afforded by a large virtual address space (80 or 52 bits).

A page address translation may be superseded by a matching block address translation as described in Section 7.4, “Block Address Translation.” If not, the page translation proceeds in the following two steps:

1. from effective address to the virtual address (which never exists as a specific entity but can be considered to be the concatenation of the virtual page number and the byte offset within a page), and
2. from virtual address to physical address.

The page address translation mechanism is described in the following sections, followed by a summary of page address translation with a detailed flow diagram.

7.5.1 Recognition of Addresses in Segments

The page address translation uses segment descriptors, which provide virtual address and protection information, and page table entries (PTEs), which provide the physical address and page protection information. The segment descriptors are programmed by the operating system to provide the virtual ID for a segment. In addition, the operating system also creates the page table in memory that provides the virtual-to-physical address mappings (in the form of PTEs) for the pages in memory.

Segments in the OEA can be classified as one of the following two types:

- Memory segment—An effective address in these segments represents a virtual address that is used to define the physical address of the page.
- Direct-store segment—References made to direct-store segments do not use the virtual paging mechanism of the processor. Note that the direct-store facility is optional and being phased out of the architecture. See Section 7.8, “Direct-Store Segment Address Translation,” for a complete description of the mapping of direct-store segments for those processors that implement it.

The T bit in the segment descriptor selects between memory segments and direct-store segments, as shown in Table 7-13.

Table 7-13. Segment Descriptor Types

Segment Descriptor T Bit	Segment Type
0	Memory segment
1	Direct-store segment—optional, but being phased out of the architecture. Its use is discouraged.

7.5.1.1 Selection of Memory Segments

All accesses generated by the processor can be mapped to a segment descriptor; however, if translation is disabled ($MSR[IR] = 0$ or $MSR[DR] = 0$ for an instruction or data access, respectively), real addressing mode translation is performed as described in Section 7.3, “Real Addressing Mode.” Otherwise, if $T = 0$ in the corresponding segment descriptor (and the address is not translated by the BAT mechanism), the access maps to memory space and page address translation is performed.

After a memory segment is selected, the processor creates the virtual address for the segment and searches for the PTE that dictates the physical page number to be used for the access. Note that I/O devices can be easily mapped into memory space and used as memory-mapped I/O.

7.5.1.2 Selection of Direct-Store Segments

As described for memory segments, all accesses generated by the processor (with translation enabled) map to a segment descriptor. If $T = 1$ for the selected segment descriptor, the access maps to the direct-store interface space and the access proceeds as described in Section 7.8, “Direct-Store Segment Address Translation.” Because the direct-store interface is present only for compatibility with existing I/O devices that used this interface and because the direct-store interface protocol is not optimized for performance, its use is discouraged. Additionally, the direct-store facility is being phased out of the architecture and future devices are not likely to support it. Thus, software should not depend on its results and new software should not use it. The most efficient method for accessing I/O is by mapping the I/O areas to memory segments.

7.5.2 Page Address Translation Overview

The first step in page address translation for 64-bit implementations is the conversion of the 64-bit effective address of an access into the 80-bit (or 64-bit) virtual address. The virtual address is then used to locate the PTE in the page table in memory. The physical page number is then extracted from the PTE and used in the formation of the physical address of the access. Note that for increased performance, some processors may implement on-chip TLBs to store copies of recently-used PTEs.

Figure 7-17 shows an overview of the translation of an effective address to a physical address for 64-bit implementations as follows:

- Bits 0–35 of the effective address comprise the effective segment ID used to select a segment descriptor, from which the virtual segment ID (VSID) is extracted.
- Bits 36–51 of the effective address correspond to the page number within the segment; these are concatenated with the VSID from the segment descriptor to form the virtual page number (VPN). The VPN is used to search for the PTE in either an on-chip TLB or the page table. The PTE then provides the physical page number (RPN). Note that bits 36–40 form the abbreviated page index (API) which is used to compare with page table entries during hashing. This is described in detail in Section 7.6.1.7.1, “PTEG Address Mapping Example—64-Bit Implementation.”
- Bits 52–63 of the effective address are the byte offset within the page; these are concatenated with the RPN field of a PTE to form the physical address used to access memory.

TEMPORARY 64-BIT BRIDGE

Because processors that implement the 64-bit bridge access only a 32-bit address space, only 16 STEs are required to define the entire 4-Gbyte address space. Page address translation for 64-bit processors using the 64-bit bridge uses a subset of the functionality described here for 64-bit implementations. For example, only bits 32–35 are used to select a segment descriptor, and as in the 32-bit portion of the architecture, only 16 on-chip segment registers are required. These segment descriptors are maintained in 16 SLB entries.

For details concerning the 64-bit bridge, see Section 7.9, “Migration of Operating Systems from 32-Bit Implementations to 64-Bit Implementations.”

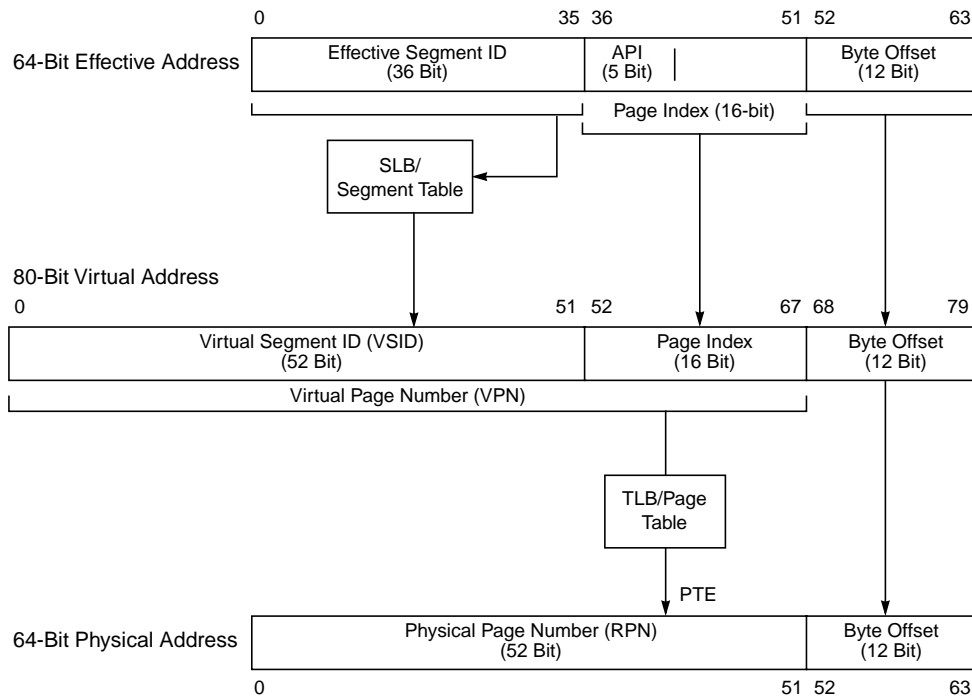

Figure 7-17. Page Address Translation Overview—64-Bit Implementations

The translation of effective addresses to physical addresses for 32-bit implementations is shown in Figure 7-18, and is similar to that for 64-bit implementations, except that 32-bit implementations index into an array of 16 on-chip segment registers instead of segment tables in memory to locate the segment descriptor, and the address ranges are obviously different, as shown in Figure 7-18. Thus, the address translation is as follows:

- Bits 0–3 of the effective address comprise the segment register number used to select a segment descriptor, from which the virtual segment ID (VSID) is extracted.
- Bits 4–19 of the effective address correspond to the page number within the segment; these are concatenated with the VSID from the segment descriptor to form the virtual page number (VPN). The VPN is used to search for the PTE in either an on-chip TLB or the page table. The PTE then provides the physical page number (RPN).
- Bits 20–31 of the effective address are the byte offset within the page; these are concatenated with the RPN field of a PTE to form the physical address used to access memory.

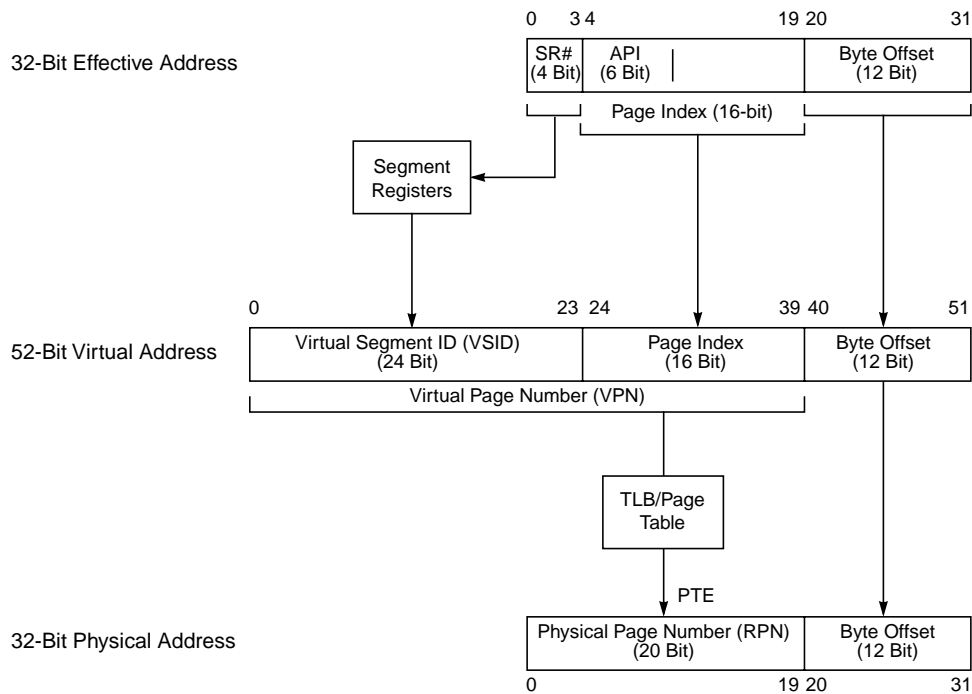

Figure 7-18. Page Address Translation Overview—32-Bit Implementations

7.5.2.1 Segment Descriptor Definitions

The format of the segment descriptors is different for 64-bit and 32-bit implementations. Additionally, the fields in the segment descriptors are interpreted differently depending on the value of the T bit within the descriptor. When T = 1, the segment descriptor defines a direct-store segment, and the format is as described in Section 7.8.1, “Segment Descriptors for Direct-Store Segments.”

TEMPORARY 64-BIT BRIDGE

For 64-bit processors using the 64-bit bridge, as is the case for 32-bit processors, only 16 segment descriptors are required, each defining 256-Mbyte segments (assuming T = 0). Although the 64-bit bridge implements 16 on-chip segment descriptors, it retains the same STE format used by 64-bit processors although values stored in the STEs reflect the smaller address space. The format for the segment descriptor used by 64-bit processors is described in Section 7.5.2.1.1, “STE Format—64-Bit Implementations.”

7.5.2.1.1 STE Format—64-Bit Implementations

In 64-bit implementations, the segment descriptors reside as segment table entries (STEs) in hashed segment tables in memory. These STEs are generated and placed in segment tables in memory by the operating system using the hashing algorithm described in Section 7.7.1.2, “Segment Table Hashing Functions.” Each STE is a 128-bit entity (two double words) that maps one effective segment ID to one virtual segment ID. Information in the STE controls the segment table search process and provides input to the memory protection mechanism. Figure 7-19 shows the format of both double words that comprise a T = 0 segment descriptor (or STE) in a 64-bit implementation.

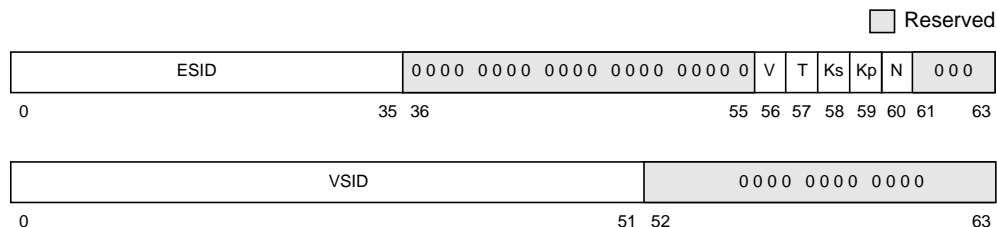

Figure 7-19. STE Format—64-Bit Implementations

Table 7-14 lists the bit definitions for each double word in an STE.

Table 7-14. STE Bit Definitions for Page Address Translation—64-Bit Implementations

Double Word	Bit	Name	Description
0	0–35	ESID	Effective segment ID
	36–55	—	Reserved
	56	V	Entry valid (V = 1) or invalid (V = 0)
	57	T	T = 0 selects this format
	58	Ks	Supervisor-state protection key
	59	Kp	User-state protection key
	60	N	No-execute protection bit
	61–63	—	Reserved
1	0–51	VSID	Virtual segment ID
	52–63	—	Reserved

The Ks and Kp bits partially define the access protection for the pages within the segment. The page protection provided in the PowerPC OEA is described in Section 7.5.4, “Page Memory Protection.” The virtual segment ID field is used as the high-order bits of the virtual page number (VPN) as shown in Figure 7-17.

Note that on implementations that support a virtual address size of only 64 bits, bits 0–15 for the VSID field must be zeros.

The segment descriptors are programmed by the operating system and placed into segment tables in memory, although some processors may additionally have on-chip segment lookaside buffers (SLBs). These SLBs store copies of recently-used STEs that can be accessed quickly, providing increased overall performance. A complete description of the structure of the segment tables is provided in Section 7.7, “Hashed Segment Tables—64-Bit Implementations.” The PowerPC OEA has defined specific instructions for controlling SLBs (if they are implemented). See Chapter 8, “Instruction Set,” for more detail on the encodings of these instructions.

TEMPORARY 64-BIT BRIDGE

Note that processors using the 64-bit bridge implement STEs as defined for 64-bit implementations as described in this section, however, from a software perspective the function of these segment descriptors is indistinguishable from the segment registers as they are defined for 32-bit implementations. However, the values in the STEs reflect only a 32-bit address space. For example, the ESID field uses only four bits (ESID[32–35]), which, like the four highest-order bits in a 32-bit effective address, provide an index to one of the 16 segment descriptors.

7.5.2.1.2 Segment Descriptor Format—32-Bit Implementations

In 32-bit implementations, the segment descriptors are 32 bits long and reside in one of 16 on-chip segment registers. Figure 7-20 shows the format of a segment register used in page address translation (T = 0) in a 32-bit implementation.

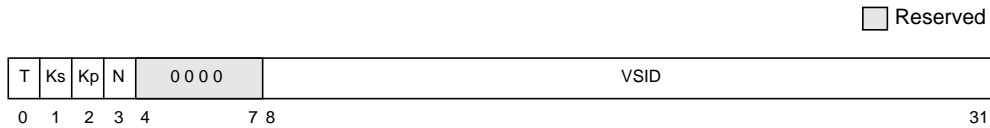

Figure 7-20. Segment Register Format for Page Address Translation—32-Bit Implementations

Table 7-15 provides the corresponding bit definitions of the segment register in 32-bit implementations.

Table 7-15. Segment Register Bit Definition for Page Address Translation—32-Bit Implementations

Bit	Name	Description
0	T	T = 0 selects this format
1	K _s	Supervisor-state protection key
2	K _p	User-state protection key
3	N	No-execute protection bit
4–7	—	Reserved
8–31	VSID	Virtual segment ID

The K_s and K_p bits partially define the access protection for the pages within the segment. The page protection provided in the PowerPC OEA is described in Section 7.5.4, “Page Memory Protection.” The virtual segment ID field is used as the high-order bits of the virtual page number (VPN) as shown in Figure 7-18.

The segment registers are programmed with specific instructions that reference the segment registers. However, since the segment registers described here are merely a conceptual model, a processor may implement separate segment registers for instructions and for data, for example. In this case, it is the responsibility of the hardware to maintain the consistency between the multiple sets of segment registers.

The segment register instructions are summarized in Table 7-16. These instructions are privileged in that they are executable only while operating in supervisor mode. See Section 2.3.18, “Synchronization Requirements for Special Registers and for Lookaside Buffers,” for information about the synchronization requirements when modifying the segment registers. See Chapter 8, “Instruction Set,” for more detail on the encodings of these instructions.

Table 7-16. Segment Register Instructions—32-Bit Implementations

Instruction	Description
mtsr SR,rS	Move to Segment Register SR[SR]← rS
mtsrin rS,rB	Move to Segment Register Indirect SR[rB[0–3]]←rS
mfsr rD,SR	Move from Segment Register rD←SR[SR]
mfsrin rD,rB	Move from Segment Register Indirect rD←SR[rB[0–3]]

Note: These instructions apply only to 32-bit implementations and 64-bit processors that implement the 64-bit bridge.

TEMPORARY 64-BIT BRIDGE

Note that segment registers and the instructions listed in Table 7-16 are intended for use in 32-bit implementations. In 64-bit implementations, these instructions are legal only in processors that support the 64-bit bridge architecture described in Section 7.9, “Migration of Operating Systems from 32-Bit Implementations to 64-Bit Implementations.” However, if these features are not supported, attempting to execute these instructions on a 64-bit implementation causes an illegal instruction program exception.

Table 7-17 lists the corresponding bit definitions for each double word in a PTE as defined.

Table 7-17. PTE Bit Definitions—64-Bit Implementations

Double Word	Bit	Name	Description
0	0–51	VSID	Virtual segment ID—corresponds to the high-order bits of the virtual page number (VPN)
	52–56	API	Abbreviated page index
	57–61	—	Reserved
	62	H	Hash function identifier
	63	V	Entry valid (V = 1) or invalid (V = 0)
1	0–51	RPN	Physical page number
	52–54	—	Reserved
	55	R	Referenced bit
	56	C	Changed bit
	57–60	WIMG	Memory/cache access control bits
	61	—	Reserved
	62–63	PP	Page protection bits

The PTE contains an abbreviated page index rather than the complete page index field because at least 11 of the low-order bits of the page index are used in the hash function to select a PTE group (PTEG) address (PTEG addresses define the location of a PTE). Therefore, these 11 lower-order bits are not repeated in the PTEs of that PTEG.

Note that on implementations that support a virtual address size of only 64 bits, bits 0–15 of the VSID field must be zeros.

7.5.2.2.2 PTE Format for 32-Bit Implementations

Figure 7-22 shows the format of the two words that comprise a PTE for 32-bit implementations.



Figure 7-22. Page Table Entry Format—32-Bit Implementations

Table 7-18 lists the corresponding bit definitions for each word in a PTE as defined above.

Table 7-18. PTE Bit Definitions—32-Bit Implementations

Word	Bit	Name	Description
0	0	V	Entry valid (V = 1) or invalid (V = 0)
	1–24	VSID	Virtual segment ID
	25	H	Hash function identifier
	26–31	API	Abbreviated page index
1	0–19	RPN	Physical page number
	20–22	—	Reserved
	23	R	Referenced bit
	24	C	Changed bit
	25–28	WIMG	Memory/cache control bits
	29	—	Reserved
	30–31	PP	Page protection bits

In this case, the PTE contains an abbreviated page index rather than the complete page index field because at least ten of the low-order bits of the page index are used in the hash function to select a PTEG address (PTEG addresses define the location of a PTE). Therefore, these ten lower-order bits are not repeated in the PTEs of that PTEG.

7.5.3 Page History Recording

Referenced (R) and changed (C) bits reside in each PTE to keep history information about the page. The operating system then uses this information to determine which areas of memory to write back to disk when new pages must be allocated in main memory. Referenced and changed recording is performed only for accesses made with page address translation and not for translations made with the BAT mechanism or for accesses that correspond to direct-store (T = 1) segments. Furthermore, R and C bits are maintained only for accesses made while address translation is enabled (MSR[IR] = 1 or MSR[DR] = 1).

In general, the referenced and changed bits are updated to reflect the status of the page based on the access, as shown in Table 7-19.

Table 7-19. Table Search Operations to Update History Bits

R and C bits	Processor Action
00	Read: Table search operation to update R Write: Table search operation to update R and C
01	Combination doesn't occur
10	Read: No special action Write: Table search operation to update C
11	No special action for read or write

In processors that implement a TLB, the processor may perform the R and C bit updates based on the copies of these bits resident in the TLB. For example, the processor may update the C bit based only on the status of the C bit in the TLB entry in the case of a TLB hit (the R bit may be assumed to be set in the page tables if there is a TLB hit). Therefore, when software clears the R and C bits in the page tables in memory, it must invalidate the TLB entries associated with the pages whose referenced and changed bits were cleared. See Section 7.6.3, “Page Table Updates,” for all of the constraints imposed on the software when updating the referenced and changed bits in the page tables.

The R bit for a page may be set by the execution of the **dcbt** or **dcbtst** instruction to that page. However, neither of these instructions cause the C bit to be set.

The update of the referenced and changed bits is performed by PowerPC processors as if address translation were disabled (real addressing mode address).

7.5.3.1 Referenced Bit

The referenced bit for each virtual page is located in the PTE. Every time a page is referenced (by an instruction fetch, or any other read or write access) the referenced bit is set in the page table. The referenced bit may be set immediately, or the setting may be delayed until the memory access is determined to be successful. Because the reference to a page is what causes a PTE to be loaded into the TLB, some processors may assume the R bit in the TLB is always set. The processor never automatically clears the referenced bit.

The referenced bit is only a hint to the operating system about the activity of a page. At times, the referenced bit may be set although the access was not logically required by the program or even if the access was prevented by memory protection. Examples of this include the following:

- Fetching of instructions not subsequently executed
- Accesses generated by an **lswx** or **stswx** instruction with a zero length
- Accesses generated by a **stwcx.** or **stdcx.** instruction when no store is performed
- Accesses that cause exceptions and are not completed

7.5.3.2 Changed Bit

The changed bit for each virtual page is located both in the PTE in the page table and in the copy of the PTE loaded into the TLB (if a TLB is implemented). Whenever a data store instruction is executed successfully, if the TLB search (for page address translation) results in a hit, the changed bit in the matching TLB entry is checked. If it is already set, the processor does not change the C bit. If the TLB changed bit is 0, it is set and a table search operation is performed to set the C bit in the corresponding PTE in the page table.

Processors cause the changed bit (in both the PTE in the page tables and in the TLB if implemented) to be set only when a store operation is allowed by the page memory protection mechanism and the store is guaranteed to be in the execution path, unless an exception, other than those caused by one of the following occurs:

- System-caused interrupts (system reset, machine check, external, and decremter interrupts)
- Floating-point enabled exception type program exceptions when the processor is in an imprecise mode
- Floating-point assist exceptions for instructions that cause no other kind of precise exception

Furthermore, the following conditions may cause the C bit to be set:

- The execution of an **stwcx.** or **stdcx.** instruction is allowed by the memory protection mechanism but a store operation is not performed.
- The execution of an **stswx** instruction is allowed by the memory protection mechanism but a store operation is not performed because the specified length is zero.
- A **dcba** or **dcbi** instruction is executed.

No other cases cause the C bit to be set.

7.5.3.3 Scenarios for Referenced and Changed Bit Recording

This section provides a summary of the model (defined by the OEA) used by PowerPC processors that maintain the referenced and changed bits automatically in hardware, in the setting of the R and C bits. In some scenarios, the bits are guaranteed to be set by the processor; in some scenarios, the architecture allows that the bits may be set (not absolutely required); and in some scenarios, the bits are guaranteed to not be set. Note that when the hardware updates the R and C bits in memory, the accesses are performed as a physical memory access, as if the WIMG bit settings were 0b0010 (that is, as unguarded cacheable operations in which coherency is required).

In implementations that do not maintain the R and C bits in hardware, software assistance is required. For these processors, the information in this section still applies, except that the software performing the updates is constrained to the rules described (that is, must set bits shown as guaranteed to be set and must not set bits shown as guaranteed to not be set). Note

that this software should be contained in the area of memory reserved for implementation-specific use and should be invisible to the operating system.

Table 7-20 defines a prioritized list of the R and C bit settings for all scenarios. The entries in the table are prioritized from top to bottom, such that a matching scenario occurring closer to the top of the table takes precedence over a matching scenario closer to the bottom of the table. For example, if an **stwcx.** instruction causes a protection violation and there is no reservation, the C bit is not altered, as shown for the protection violation case. Note that in the table, load operations include those generated by load instructions, by the **eciwx** instruction, and by the cache management instructions that are treated as loads with respect to address translation. Similarly, store operations include those operations generated by store instructions, by the **ecowx** instruction, and by the cache management instructions that are treated as stores with respect to address translation.

Table 7-20. Model for Guaranteed R and C Bit Settings

Priority	Scenario	Causes Setting of R Bit	Causes Setting of C Bit
1	No-execute protection violation	No	No
2	Page protection violation	Maybe	No
3	Out-of-order instruction fetch or load operation	Maybe	No
4	Out-of-order store operation for instructions that will cause no other kind of precise exception (in the absence of system-caused, imprecise, or floating-point assist exceptions)	Maybe ¹	Maybe ¹
5	All other out-of-order store operations	Maybe ¹	No
6	Zero-length load (lswx)	Maybe	No
7	Zero-length store (stswx)	Maybe ¹	Maybe ¹
8	Store conditional (stwcx. , or stdcx.) that does not store	Maybe ¹	Maybe ¹
9	In-order instruction fetch	Yes ²	No
10	Load instruction or eciwx	Yes	No
11	Store instruction, ecowx , dcbz , or dcba ³ instruction	Yes	Yes
12	icbi , dcbt , dcbtst , dcbst , or dcbf instruction	Maybe	No
13	dcbi instruction	Maybe ¹	Maybe ¹

Notes:

¹ If C is set, R is guaranteed to also be set.

² This includes the case in which the instruction was fetched out of order and R was not set.

³ For a **dcba** instruction that does not modify the target block, it is possible that neither bit is set.

7.5.3.4 Synchronization of Memory Accesses and Referenced and Changed Bit Updates

Although the processor updates the referenced and changed bits in the page tables automatically, these updates are not guaranteed to be immediately visible to the program after the load, store, or instruction fetch operation that caused the update. If processor A executes a load or store or fetches an instruction, the following conditions are met with respect to performing the access and performing any R and C bit updates:

- If processor A subsequently executes a **sync** instruction, both the updates to the bits in the page table and the load or store operation are guaranteed to be performed with respect to all processors and mechanisms before the **sync** instruction completes on processor A.
- Additionally, if processor B executes a **tlbie** instruction that
 - signals the invalidation to the hardware,
 - invalidates the TLB entry for the access in processor A, and
 - is detected by processor A after processor A has begun the access,and processor B executes a **tlbsync** instruction after it executes the **tlbie**, both the updates to the bits and the original access are guaranteed to be performed with respect to all processors and mechanisms before the **tlbsync** instruction completes on processor A.

7.5.4 Page Memory Protection

In addition to the no-execute option that can be programmed at the segment descriptor level to prevent instructions from being fetched from a given segment (shown in Figure 7-5), there are a number of other memory protection options that can be programmed at the page level. The page memory protection mechanism allows selectively granting read access, granting read/write access, and prohibiting access to areas of memory based on a number of control criteria.

The memory protection used by the block and page address translation mechanisms is different in that the page address translation protection defines a key bit that, in conjunction with the PP bits, determines whether supervisor and user programs can access a page. For specific information about block address translation, refer to Section 7.4.4, “Block Memory Protection.”

For page address translation, the memory protection mechanism is controlled by the following:

- MSR[PR], which defines the mode of the access as follows:
 - MSR[PR] = 0 corresponds to supervisor mode
 - MSR[PR] = 1 corresponds to user mode
- Ks and Kp, the supervisor and user key bits, which define the key for the page
- The PP bits, which define the access options for the page

The key bits (Ks and Kp) and the PP bits are located as follows for page address translation:

- Ks and Kp are located in the segment descriptor.
- The PP bits are located in the PTE.

The key bits, the PP bits, and the MSR[PR] bit are used as follows:

- When an access is generated, one of the key bits is selected to be the key as follows:
 - For supervisor accesses (MSR[PR] = 0), the Ks bit is used and Kp is ignored
 - For user accesses (MSR[PR] = 1), the Kp bit is used and Ks is ignored
 That is, $\text{key} = (\text{Kp} \ \& \ \text{MSR}[\text{PR}]) \ | \ (\text{Ks} \ \& \ \neg\text{MSR}[\text{PR}])$
- The selected key is used with the PP bits to determine if instruction fetching, load access, or store access is allowed.

Table 7-21 shows the types of accesses that are allowed for the general case (all possible Ks, Kp, and PP bit combinations), assuming that the N bit in the segment descriptor is cleared (the no-execute option is not selected).

Table 7-21. Access Protection Control with Key

Key ¹	PP ²	Page Type
0	00	Read/write
0	01	Read/write
0	10	Read/write
0	11	Read only
1	00	No access
1	01	Read only
1	10	Read/write
1	11	Read only

Notes:

¹ Ks or Kp selected by state of MSR[PR]

² PP protection option bits in PTE

Thus, the conditions that cause a protection violation (not including the no-execute protection option for instruction fetches) are depicted in Table 7-22 and as a flow diagram in Figure 7-25. Any access attempted (read or write) when the key = 1 and PP = 00, causes a protection violation exception condition. When key = 1 and PP = 01, an attempt to perform a write access causes a protection violation exception condition. When PP = 10, all accesses are allowed, and when PP = 11, write accesses always cause an exception. The processor takes either the ISI or the DSI exception (for an instruction or data access, respectively) when there is an attempt to violate the memory protection.

Table 7-22. Exception Conditions for Key and PP Combinations

Key	PP	Prohibited Accesses
0	0x	None
1	00	Read/write
1	01	Write
x	10	None
x	11	Write

Any combination of the Ks, Kp, and PP bits is allowed. One example is if the Ks and Kp bits are programmed so that the value of the key bit for Table 7-21 directly matches the MSR[PR] bit for the access. In this case, the encoding of Ks = 0 and Kp = 1 is used for the PTE, and the PP bits then enforce the protection options shown in Table 7-23.

Table 7-23. Access Protection Encoding of PP Bits for Ks = 0 and Kp = 1

PP Field	Option	User Read (Key = 1)	User Write (Key = 1)	Supervisor Read (Key = 0)	Supervisor Write (Key = 0)
00	Supervisor-only	Violation	Violation	√	√
01	Supervisor-write-only	√	Violation	√	√
10	Both user/supervisor	√	√	√	√
11	Both read-only	√	Violation	√	Violation

However, if the setting Ks = 1 is used, supervisor accesses are treated as user reads and writes with respect to Table 7-23. Likewise, if the setting Kp = 0 is used, user accesses to the page are treated as supervisor accesses in relation to Table 7-23. Therefore, by modifying one of the key bits (in the segment descriptor), the way the processor interprets accesses (supervisor or user) in a particular segment can easily be changed. Note, however, that only supervisor programs are allowed to modify the key bits for the segment descriptor. For 64-bit implementations, although access to the ASR is privileged, the operating system must protect write accesses to the segment table as well. For 32-bit implementations, access to the segment registers is privileged.

When the memory protection mechanism prohibits a reference, the flow of events is similar to that for a memory protection violation occurring with the block protection mechanism. As shown in Figure 7-23, one of the following occurs depending on the type of access that was attempted:

- For data accesses, a DSI exception is generated and DSISR[4] is set. If the access is a store, DSISR[6] is also set.
- For instruction accesses,
 - an ISI exception is generated and SRR1[36] (SRR1[4] for 32-bit implementations) is set, or
 - an ISI exception is generated and SRR1[35] (SRR1[3] for 32-bit implementations) is set if the segment is designated as no-execute.

The only difference between the flow shown in Figure 7-23 and that of the block memory protection violation is the ISI exception that can be caused by an attempt to fetch an instruction from a segment that has been designated as no-execute (N bit set in the segment descriptor). See Chapter 6, “Exceptions,” for more information about these exceptions.

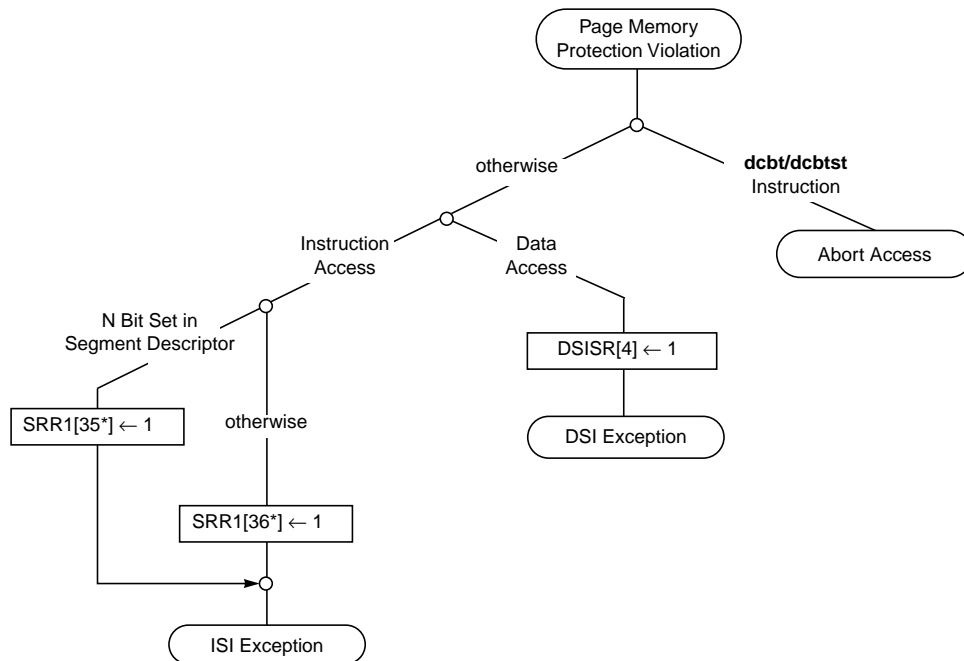

Note: *Subtract 32 from bit number for bit setting in 32-bit implementations.

Figure 7-23. Memory Protection Violation Flow for Pages

If the page protection mechanism prohibits a store operation, the changed bit is not set (in either the TLB or in the page tables in memory); however, a prohibited store access may cause a PTE to be loaded into the TLB and consequently cause the referenced bit to be set in a PTE (both in the TLB and in the page table in memory).

7.5.5 Page Address Translation Summary

Figure 7-24 provides the detailed flow for the page address translation mechanism in 64-bit implementations. The figure includes the checking of the N bit in the segment descriptor and then expands on the ‘TLB Hit’ branch of Figure 7-5. The detailed flow for the ‘TLB Miss’ branch of Figure 7-5 is described in Section 7.6.2, “Page Table Search Operation.” The checking of memory protection violation conditions for page address translation is shown in Figure 7-25. The ‘Invalidate TLB Entry’ box shown in Figure 7-24 is marked as implementation-specific as this level of detail for TLBs (and the existence of TLBs) is not dictated by the architecture. Note that the figure does not show the detection of all exception conditions shown in Table 7-5 and Table 7-6; the flow for many of these exceptions is implementation-specific.

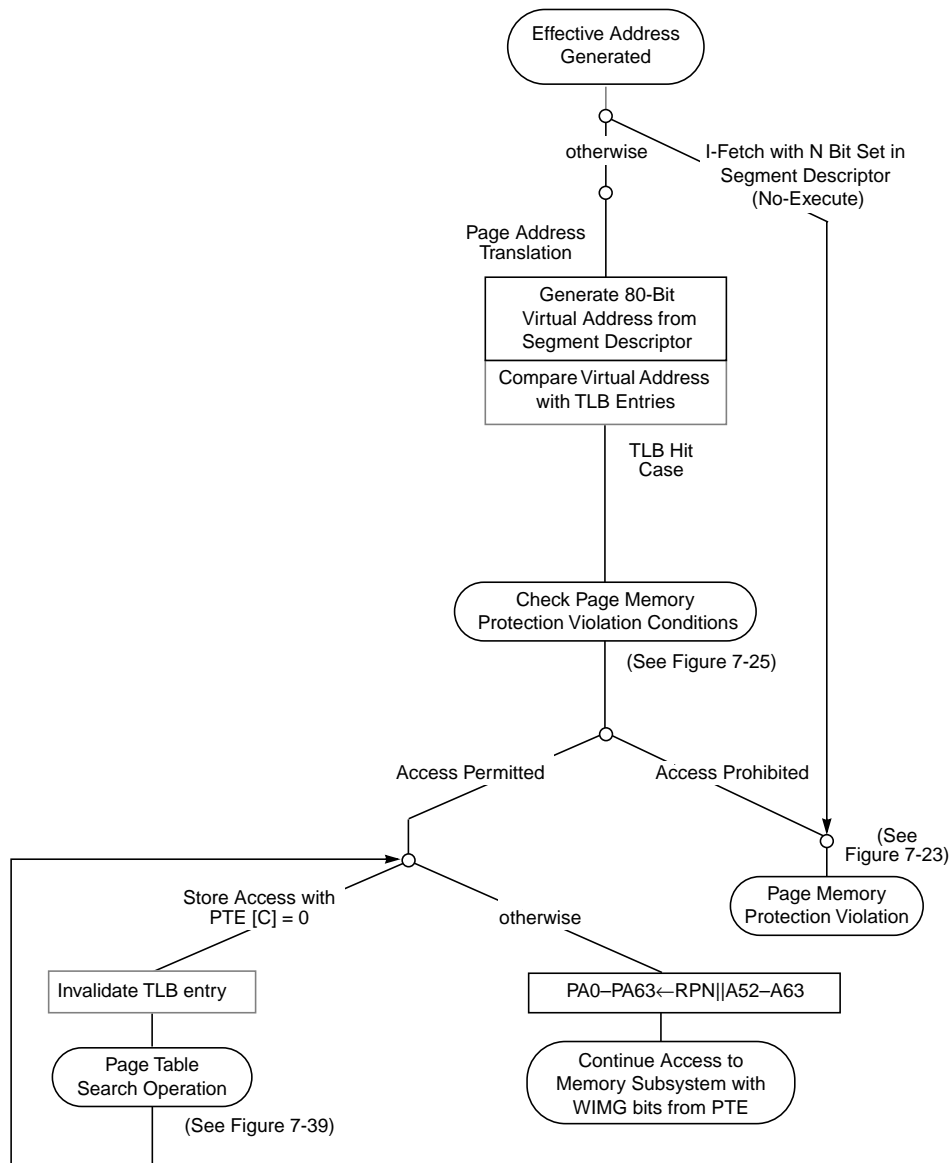

Note: — Implementation-specific

Figure 7-24. Page Address Translation Flow for 64-Bit Implementations—TLB Hit

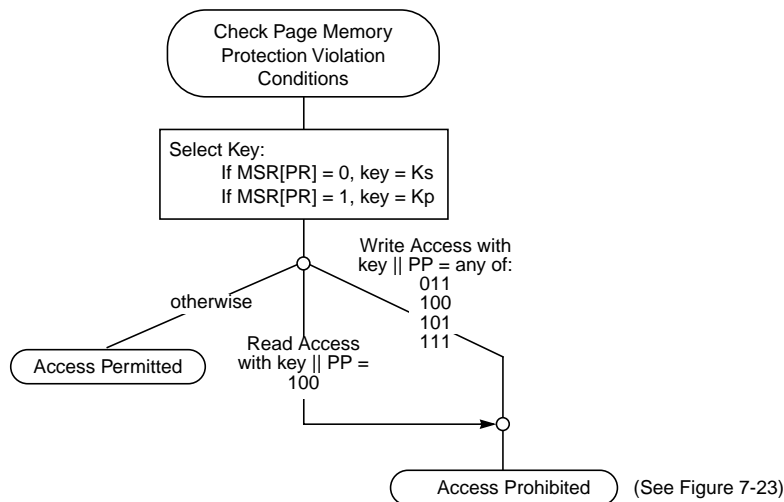

Figure 7-25. Page Memory Protection Violation Conditions for Page Address Translation

7.6 Hashed Page Tables

If a copy of the PTE corresponding to the VPN for an access is not resident in a TLB (corresponding to a miss in the TLB, provided a TLB is implemented), the processor must search for the PTE in the page tables set up by the operating system in main memory.

The algorithm specified by the architecture for accessing the page tables includes a hashing function on some of the virtual address bits. Thus, the addresses for PTEs are allocated more evenly within the page tables and the hit rate of the page tables is maximized. This algorithm must be synthesized by the operating system for it to correctly place the page table entries in main memory.

If page table search operations are performed automatically by the hardware, they are performed using physical addresses and as if the memory access attribute bit $M = 1$ (memory coherency enforced in hardware). If the software performs the page table search operations, the accesses must be performed in real addressing mode ($MSR[DR] = 0$); this additionally guarantees that $M = 1$.

This section describes the format of the page tables and the algorithm used to access them. In addition, the constraints imposed on the software in updating the page tables (and other MMU resources) are described.

7.6.1 Page Table Definition

The hashed page table is a variable-sized data structure that defines the mapping between virtual page numbers and physical page numbers. The page table size is a power of 2, its starting address is a multiple of its size, and the table must reside in memory with the WIMG attributes of 0b0010.

The page table contains a number of page table entry groups (PTEGs). For 64-bit implementations, a PTEG contains eight page table entries (PTEs) of 16 bytes each; therefore, each PTEG is 128 bytes long. For 32-bit implementations, a PTEG contains eight PTEs of eight bytes each; therefore, each PTEG is 64 bytes long. PTEG addresses are entry points for table search operations. Figure 7-26 shows two PTEG addresses (PTEGaddr1 and PTEGaddr2) where a given PTE may reside.

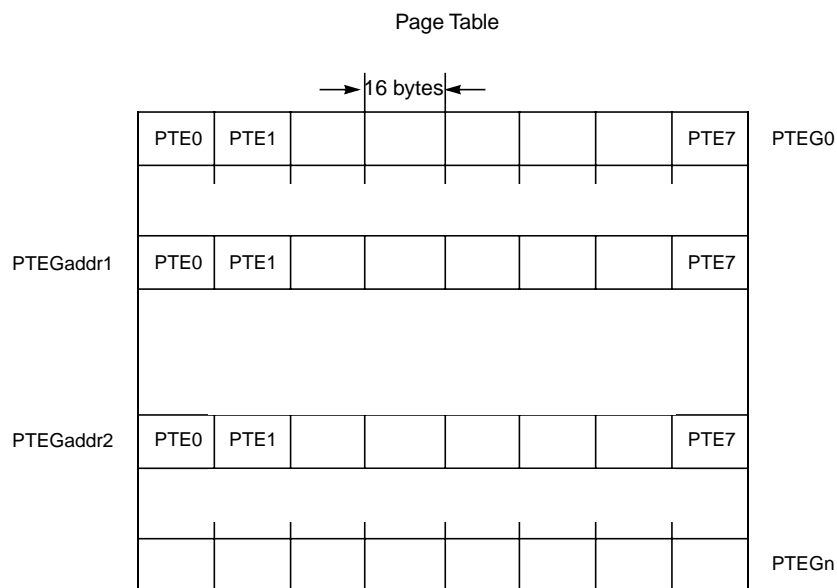

Figure 7-26. Page Table Definitions

A given PTE can reside in one of two possible PTEGs—one is the primary PTEG and the other is the secondary PTEG. Additionally, a given PTE can reside in any of the PTE locations within an addressed PTEG. Thus, a given PTE may reside in one of 16 possible locations within the page table. If a given PTE is not in either the primary or secondary PTEG, a page table miss occurs, corresponding to a page fault condition.

A table search operation is defined as the search for a PTE within a primary and secondary PTEG. When a table search operation commences, a primary hashing function is performed on the virtual address. The output of the hashing function is then concatenated with bits programmed into the SDR1 register by the operating system to create the physical address

of the primary PTEG. The PTEs in the PTEG are then checked, one by one, to see if there is a hit within the PTEG. If the PTE is not located, a secondary hashing function is performed, a new physical address is generated for the PTEG, and the PTE is searched for again, using the secondary PTEG address.

Note, however, that although a given PTE may reside in one of 16 possible locations, an address that is a primary PTEG address for some accesses also functions as a secondary PTEG address for a second set of accesses (as defined by the secondary hashing function). Therefore, these 16 possible locations are really shared by two different sets of effective addresses. Section 7.6.1.6, “Page Table Structure Examples,” illustrates how PTEs map into the 16 possible locations as primary and secondary PTEs.

7.6.1.1 SDR1 Register Definitions

The SDR1 register contains the control information for the page table structure in that it defines the high-order bits for the physical base address of the page table and it defines the size of the table. Note that there are certain synchronization requirements for writing to SDR1 that are described in Section 2.3.18, “Synchronization Requirements for Special Registers and for Lookaside Buffers.” The format of the SDR1 register differs for 64-bit and 32-bit implementations, as shown in the following sections.

7.6.1.1.1 SDR1 Register Definition for 64-Bit Implementations

The format of the SDR1 register for a 64-bit implementation is shown in Figure 7-27.

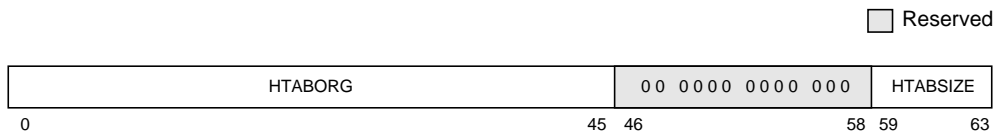

Figure 7-27. SDR1 Register Format—64-Bit Implementations

The bit settings for SDR1 are described in Table 7-24.

Table 7-24. SDR1 Register Bit Settings—64-Bit Implementations

Bits	Name	Description
0–45	HTABORG	Physical base address of page table
46–58	—	Reserved
59–63	HTABSIZE	Encoded size of page table (used to generate mask)

The HTABORG field in SDR1 contains the high-order 46 bits of the 64-bit physical address of the page table. Therefore, the beginning of the page table lies on a 2^{18} byte (256 Kbyte) boundary at a minimum. If the processor does not support 64 bits of physical address, software should write zeros to those unsupported bits in the HTABORG field (as the implementation treats them as reserved). Otherwise, a machine check exception can occur.

A page table can be any size 2^n bytes where $18 \leq n \leq 46$. The HTABSIZE field in SDR1 contains an integer value that specifies how many bits from the output of the hashing function are used as the page table index. This number must not exceed 28. HTABSIZE is used to generate a mask of the form 0b00...011...1 (a string of n 0 bits (where n is $28 - \text{HTABSIZE}$) followed by a string of 1 bits, the number of which is equal to the value of HTABSIZE). As the table size increases, more bits are used from the output of the hashing function to index into the table. The 1 bits in the mask determine how many additional bits (beyond the minimum of 11) from the hash are used in the index; the HTABORG field must have this same number of low-order bits equal to 0. See Figure 7-35 for an example of the primary PTEG address generation in a 64-bit implementation.

For example, suppose that the page table is 16,384 (2^{14}), 128-byte PTEGs, for a total size of 2^{21} bytes (2 Mbytes). Note that a 14-bit index is required. Eleven bits are provided from the hash initially, so three additional bits from the hash must be selected. The value in HTABSIZE must be 3 and the value in HTABORG must have its low-order three bits (bits 31–33 of SDR1) equal to 0. This means that the page table must begin on a $2^{3+11+7} = 2^{21} = 2$ Mbytes boundary.

On implementations that support a virtual address size of only 64 bits, software should set the HTABSIZE field to a value that does not exceed 25. Because the high-order 16 bits of the VSID must be zeros for these implementations, the hash value used in the page table search will have the high-order three bits either all zeros (primary hash) or all ones (secondary hash). If $\text{HTABSIZE} > 25$, some of these hash value bits will be used to index into the page table, resulting in certain PTEGs never being searched.

7.6.1.1.2 SDR1 Register Definition for 32-Bit Implementations

The format of SDR1 for 32-bit implementations is similar to that of 64-bit implementations except that the register size is 32 bits and the HTABMASK field is programmed explicitly into SDR1. Additionally, the address ranges correspond to a 32-bit physical address and the range of page table sizes is smaller. Figure 7-28 shows the format of the SDR1 register for 32-bit implementations; the bit settings are described in Table 7-25.

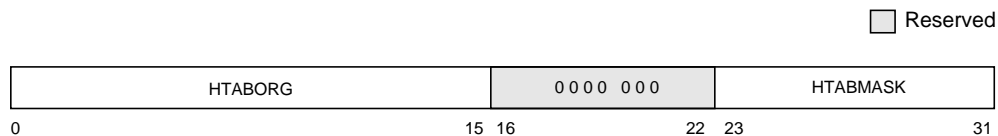

Figure 7-28. SDR1 Register Format—32-Bit Implementations

Table 7-25. SDR1 Register Bit Settings—32-Bit Implementations

Bits	Name	Description
0–15	HTABORG	Physical base address of page table
16–22	—	Reserved
23–31	HTABMASK	Mask for page table address

The HTABORG field in SDR1 contains the high-order 16 bits of the 32-bit physical address of the page table. Therefore, the beginning of the page table lies on a 2^{16} byte (64 Kbyte) boundary at a minimum. As with 64-bit implementations, if the processor does not support 32 bits of physical address, software should write zeros to those unsupported bits in the HTABORG field (as the implementation treats them as reserved). Otherwise, a machine check exception can occur.

A page table can be any size 2^n bytes where $16 \leq n \leq 25$. The HTABMASK field in SDR1 contains a mask value that determines how many bits from the output of the hashing function are used as the page table index. This mask must be of the form 0b00...011...1 (a string of 0 bits followed by a string of 1 bits). As the table size increases, more bits are used from the output of the hashing function to index into the table. The 1 bits in HTABMASK determine how many additional bits (beyond the minimum of 10) from the hash are used in the index; the HTABORG field must have the same number of lower-order bits equal to 0 as the HTABMASK field has lower-order bits equal to 1.

Example:

Suppose that the page table is 16,384 (2^{14}) 128-byte PTEGs, for a total size of 2^{21} bytes (2 Mbytes). A 14-bit index is required. Eleven bits are provided from the hash to start with, so 3 additional bits from the hash must be selected. Thus the value in HTABMASK must be 3 and the value in HTABORG must have its low-order 3 bits (SDR1[31–33]) equal to 0. This means that the page table must begin on a $2^{3+11+7} = 2^{21} = 2$ -Mbyte boundary.

7.6.1.2 Page Table Size

The number of entries in the page table directly affects performance because it influences the hit ratio in the page table and thus the rate of page fault exception conditions. If the table is too small, not all virtual pages that have physical page frames assigned may be mapped via the page table. This can happen if more than 16 entries map to the same primary/secondary pair of PTEGs; in this case, many hash collisions may occur.

7.6.1.2.1 Page Table Sizes for 64-Bit Implementations

In 64-bit implementations, the minimum allowable size for a page table is 256 Kbytes (2^{11} PTEGs of 128 bytes each). However, it is recommended that the total number of PTEGs in the page table be at least half the number of physical page frames to be mapped. While avoidance of hash collisions cannot be guaranteed for any size page table, making the page table larger than the recommended minimum size reduces the frequency of such collisions, by making the primary PTEGs more sparsely populated, and further reducing the need to use the secondary PTEGs.

Table 7-26 shows example sizes for total main memory. The recommended minimum page table sizes for these example memory sizes are then outlined, along with their corresponding HTABORG and HTABSIZE settings. Note that systems with less than 16 Mbytes of main memory may be designed with 64-bit implementations, but the minimum amount of memory that can be used for the page tables is 256 Kbytes in these cases.

Table 7-26. Minimum Recommended Page Table Sizes—64-Bit Implementations

Total Main Memory	Recommended Minimum			Settings for Recommended Minimum	
	Memory for Page Tables	Number of Mapped Pages (PTEs)	Number of PTEGs	HTABORG (Maskable Bits 18-45)	HTABSIZE (28-Bit Mask)
16 Mbytes (2^{24})	256 Kbytes (2^{18})	2^{14}	2^{11}	x xxxx	0 0000 (0 0000)
32 Mbytes (2^{25})	512 Kbytes (2^{19})	2^{15}	2^{12}	x xxx0	0 0001 (0 0001)
64 Mbytes (2^{26})	1 Mbyte (2^{20})	2^{16}	2^{13}	x xx00	0 0010 (0 0011)
128 Mbytes (2^{27})	2 Mbytes (2^{21})	2^{17}	2^{14}	x x000	0 0011 (0 0111)
256 Mbytes (2^{28})	4 Mbytes (2^{22})	2^{18}	2^{15}	x . . . x 0000	0 0100 (0 . . . 0 1111)
.
.
.
2^{51} Bytes	2^{45} Bytes	2^{41}	2^{38}	x 0 . . . 0000	1 1011 (0 1 . . . 1111)
2^{52} Bytes	2^{46} Bytes	2^{42}	2^{39}	0 0000	1 1100 (1 1111)

As an example, if the physical memory size is 2^{31} bytes (2 Gbyte), there are $2^{31} - 2^{12}$ (4 Kbyte page size) = 2^{19} (512 Kbyte) total page frames. If this number of page frames is divided by 2, the resultant minimum recommended page table size is 2^{18} PTEGs, or 2^{25} bytes (32 Mbytes) of memory for the page tables.

7.6.1.2.2 Page Table Sizes for 32-Bit Implementations

The recommended page table sizes in 32-bit implementations are similar to that of 64-bit implementations, except that the total number of pages mapped for a given page table size is larger, because the PTEs are only 8 bytes (instead of 16 bytes) in length. In a 32-bit implementation, the minimum size for a page table is 64 Kbytes (2^{10} PTEGs of 64 bytes each). However, as with the 64-bit model, it is recommended that the total number of PTEGs in the page table be at least half the number of physical page frames to be mapped. While avoidance of hash collisions cannot be guaranteed for any size page table, making the page table larger than the recommended minimum size reduces the frequency of such collisions by making the primary PTEGs more sparsely populated, and further reducing the need to use the secondary PTEGs.

Table 7-27 shows some example sizes for total main memory in a 32-bit system. The recommended minimum page table size for these example memory sizes are then outlined, along with their corresponding HTABORG and HTABMASK settings in SDR1. Note that systems with less than 8 Mbytes of main memory may be designed with 32-bit processors, but the minimum amount of memory that can be used for the page tables in these cases is 64 Kbytes.

Table 7-27. Minimum Recommended Page Table Sizes—32-Bit Implementations

Total Main Memory	Recommended Minimum			Settings for Recommended Minimum	
	Memory for Page Tables	Number of Mapped Pages (PTEs)	Number of PTEGs	HTABORG (Maskable Bits 7–15)	HTABMASK
8 Mbytes (2^{23})	64 Kbytes (2^{16})	2^{13}	2^{10}	x xxxx xxxx	0 0000 0000
16 Mbytes (2^{24})	128 Kbytes (2^{17})	2^{14}	2^{11}	x xxxx xxx0	0 0000 0001
32 Mbytes (2^{25})	256 Kbytes (2^{18})	2^{15}	2^{12}	x xxxx xx00	0 0000 0011
64 Mbytes (2^{26})	512 Kbytes (2^{19})	2^{16}	2^{13}	x xxxx x000	0 0000 0111
128 Mbytes (2^{27})	1 Mbyte (2^{20})	2^{17}	2^{14}	x xxxx 0000	0 0000 1111
256 Mbytes (2^{28})	2 Mbytes (2^{21})	2^{18}	2^{15}	x xxx0 0000	0 0001 1111
512 Mbytes (2^{29})	4 Mbytes (2^{22})	2^{19}	2^{16}	x xx00 0000	0 0011 1111
1 Gbytes (2^{30})	8 Mbytes (2^{23})	2^{20}	2^{17}	x x000 0000	0 0111 1111
2 Gbytes (2^{31})	16 Mbytes (2^{24})	2^{21}	2^{18}	x 0000 0000	0 1111 1111
4 Gbytes (2^{32})	32 Mbytes (2^{25})	2^{22}	2^{19}	0 0000 0000	1 1111 1111

As an example, if the physical memory size is 2^{29} bytes (512 Mbyte), then there are $2^{29} - 2^{12}$ (4 Kbyte page size) = 2^{17} (128 Kbyte) total page frames. If this number of page frames is divided by 2, the resultant minimum recommended page table size is 2^{16} PTEGs, or 2^{22} bytes (4 Mbytes) of memory for the page tables.

7.6.1.3 Page Table Hashing Functions

The MMU uses two different hashing functions, a primary and a secondary, in the creation of the physical addresses used in a page table search operation. These hashing functions distribute the PTEs within the page table, in that there are two possible PTEGs where a given PTE can reside. Additionally, there are eight possible PTE locations within a PTEG where a given PTE can reside. If a PTE is not found using the primary hashing function, the secondary hashing function is performed, and the secondary PTEG is searched. Note that these two functions must also be used by the operating system to set up the page tables in memory appropriately.

Typically, the hashing functions provide a high probability that a required PTE is resident in the page table, without requiring the definition of all possible PTEs in main memory. However, if a PTE is not found in the secondary PTEG, a page fault occurs and an exception is taken. Thus, the required PTE can then be placed into either the primary or secondary PTEG by the system software, and on the next TLB miss to this page (in those processors that implement a TLB), the PTE will be found in the page tables (and loaded into an on-chip TLB).

The address of a PTEG is derived from the HTABORG field of the SDR1 register, and the output of the corresponding hashing function (primary hashing function for primary PTEG and secondary hashing function for a secondary PTEG). The value in the HTABSIZE field of SDR1 (HTABMASK field for 32-bit implementations) determines how many of the higher-order hash value bits are masked and how many are used in the generation of the physical address of the PTEG.

7.6.1.3.1 Page Table Hashing Functions—64-Bit Implementations

Figure 7-29 depicts the hashing functions defined by the PowerPC OEA for page tables. The inputs to the primary hashing function are the lower-order 39 bits of the VSID field of the STE (bits 13–51 of the 80-bit virtual address), and the page index field of the effective address (bits 52–67 of the virtual address) concatenated with 23 higher-order bits of zero. The XOR of these two values generates the output of the primary hashing function (hash value 1).

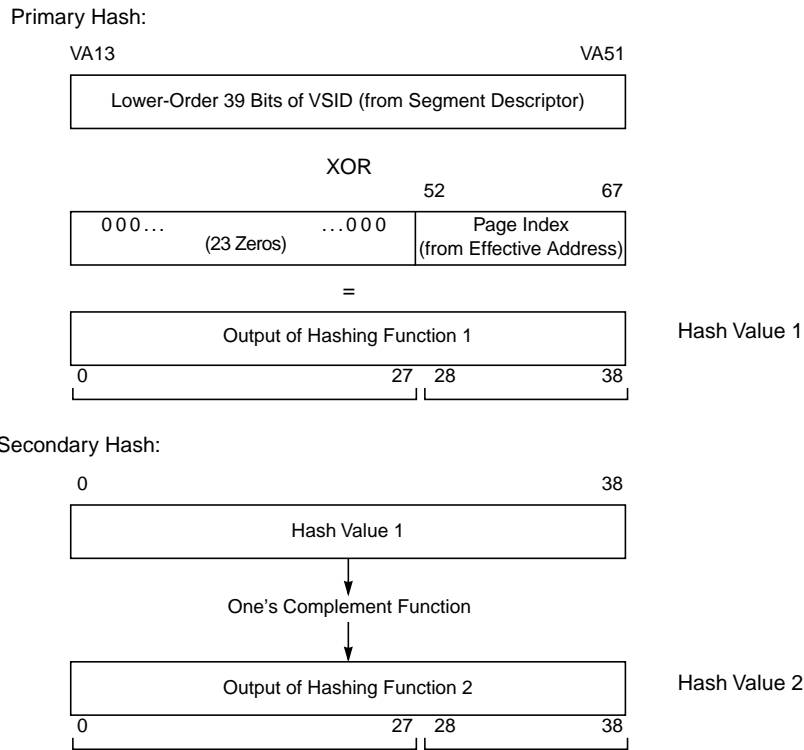

Figure 7-29. Hashing Functions for Page Tables—64-Bit Implementations

When the secondary hashing function is required, the output of the primary hashing function is complemented with one's complement arithmetic, to provide hash value 2.

7.6.1.3.2 Page Table Hashing Functions—32-Bit Implementations

Figure 7-30 depicts the hashing functions defined by the PowerPC OEA for 32-bit implementations. The inputs to the primary hashing function are the lower-order 19 bits of the VSID field of the selected segment register (bits 5–23 of the 52-bit virtual address), and the page index field of the effective address (bits 24–39 of the virtual address) concatenated with three zero higher-order bits. The XOR of these two values generates the output of the primary hashing function (hash value 1).

As is the case for 64-bit implementations, when the secondary hashing function is required, the output of the primary hashing function is complemented with one's complement arithmetic, to provide hash value 2.

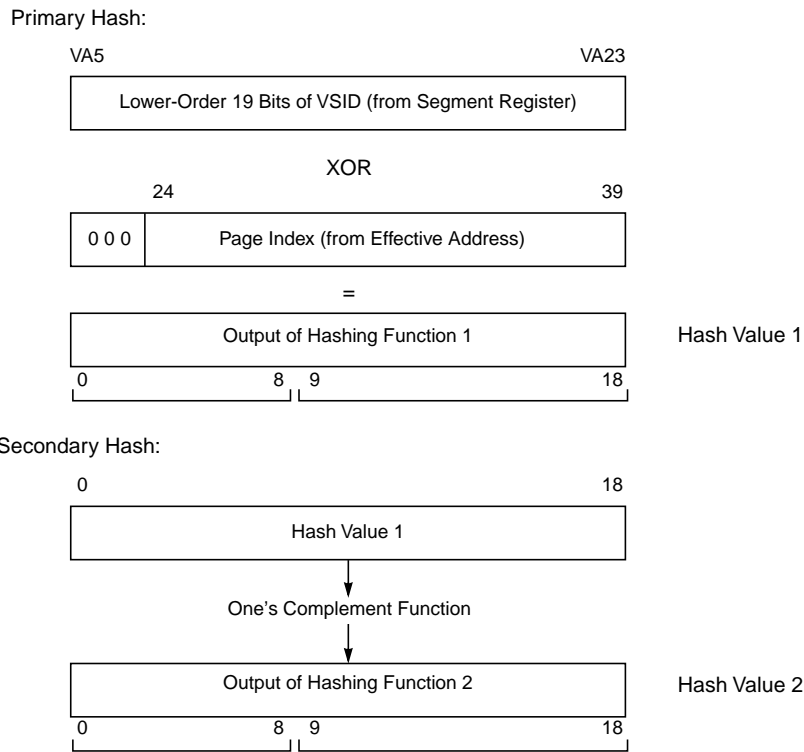

Figure 7-30. Hashing Functions for Page Tables—32-Bit Implementations

7.6.1.4 Page Table Addresses

The following sections illustrate the generation of the addresses used for accessing the hashed page tables for both 64- and 32-bit implementations. As stated earlier, the operating system must synthesize the table search algorithm for setting up the tables.

Two of the elements that define the virtual address (the VSID field of the segment descriptor and the page index field of the effective address) are used as inputs into a hashing function. Depending on whether the primary or secondary PTEG is to be accessed, the processor uses either the primary or secondary hashing function as described in Section 7.6.1.3, “Page Table Hashing Functions.”

Note that unless all accesses to be performed by the processor can be translated by the BAT mechanism when address translation is enabled ($MSR[DR]$ or $MSR[IR] = 1$), the SDR1 must point to a valid page table. Otherwise, a machine check exception can occur.

Additionally, care should be given that page table addresses not conflict with those that correspond to areas of the physical address map reserved for the exception vector table or other implementation-specific purposes (refer to Section 7.2.1.2, “Predefined Physical Memory Locations”).

7.6.1.4.1 Page Table Address Generation for 64-Bit Implementations

The base address of the page table is defined by the high-order bits of SDR1[HTABORG]. Effectively, bits 18–45 of the PTEG address are derived from the masking of the higher-order bits of the hash value (as defined by SDR1[HTABSIZE]) concatenated with (implemented as an OR function) the high-order bits of SDR1[HTABORG] as defined by HTABSIZE. Bits 46–56 of the PTEG address are the 11 lower-order bits of the hash value, and bits 57–63 of the PTEG address are zero. In the process of searching for a PTE, the processor checks up to eight PTEs located in the primary PTEG and up to eight PTEs located in the secondary PTEG, if required, searching for a match. Figure 7-31 provides a graphical description of the generation of the PTEG addresses for 64-bit implementations.

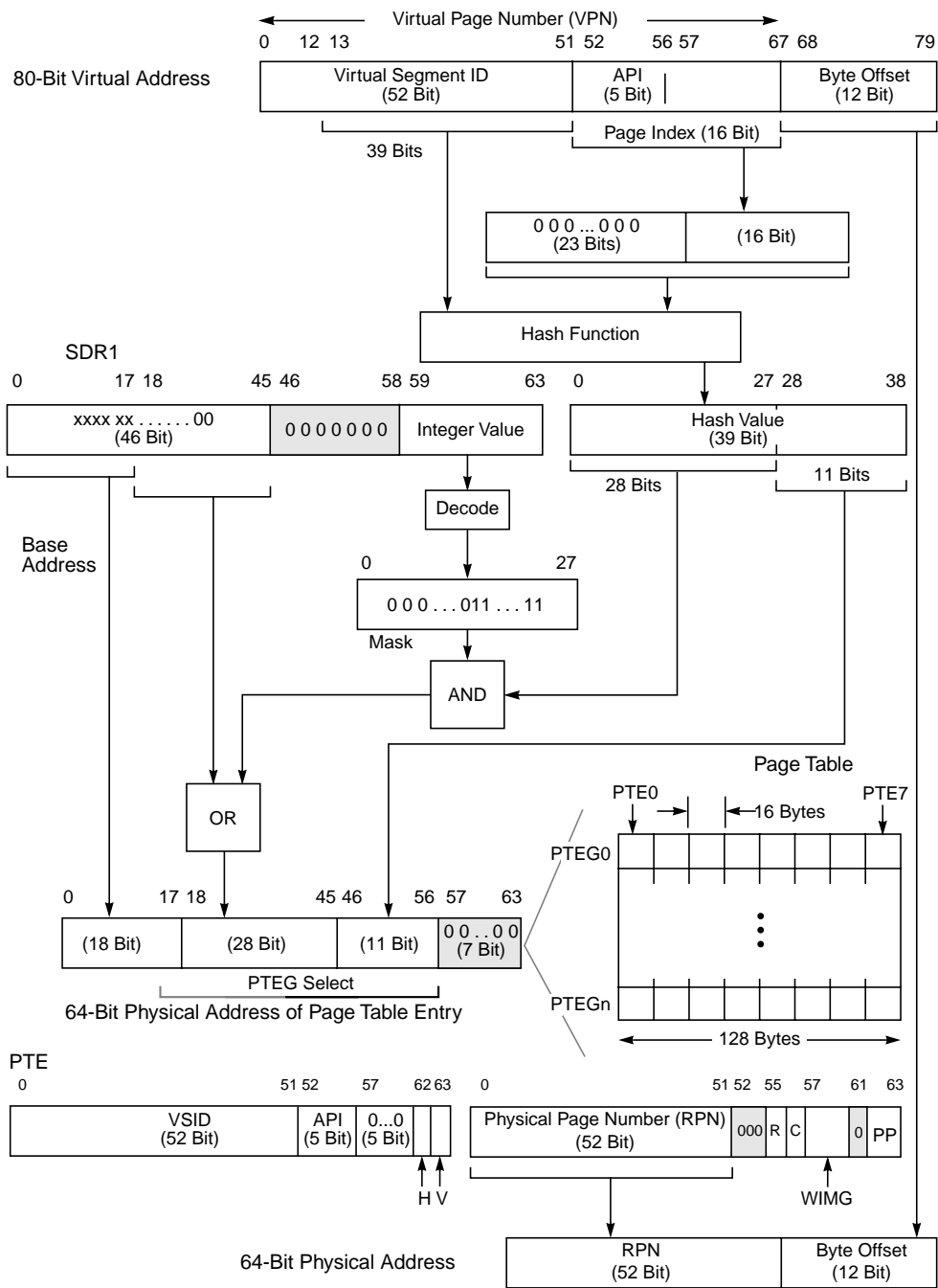

Figure 7-31. Generation of Addresses for Page Tables—64-Bit Implementations

7.6.1.4.2 Page Table Address Generation for 32-Bit Implementations

For 32-bit implementations, the base address of the page table is defined by the high-order bits of SDR1[HTABORG].

Effectively, bits 7–15 of the PTEG address are derived from the masking of the higher-order bits of the hash value (as defined by SDR1[HTABMASK]) concatenated with (implemented as an OR function) the high-order bits of SDR1[HTABORG] as defined by HTABMASK. Bits 16–25 of the PTEG address are the 10 lower-order bits of the hash value, and bits 26–31 of the PTEG address are zero. In the process of searching for a PTE, the processor checks up to eight PTEs located in the primary PTEG and up to eight PTEs located in the secondary PTEG, if required, searching for a match. Figure 7-32 provides a graphical description of the generation of the PTEG addresses for 32-bit implementations.

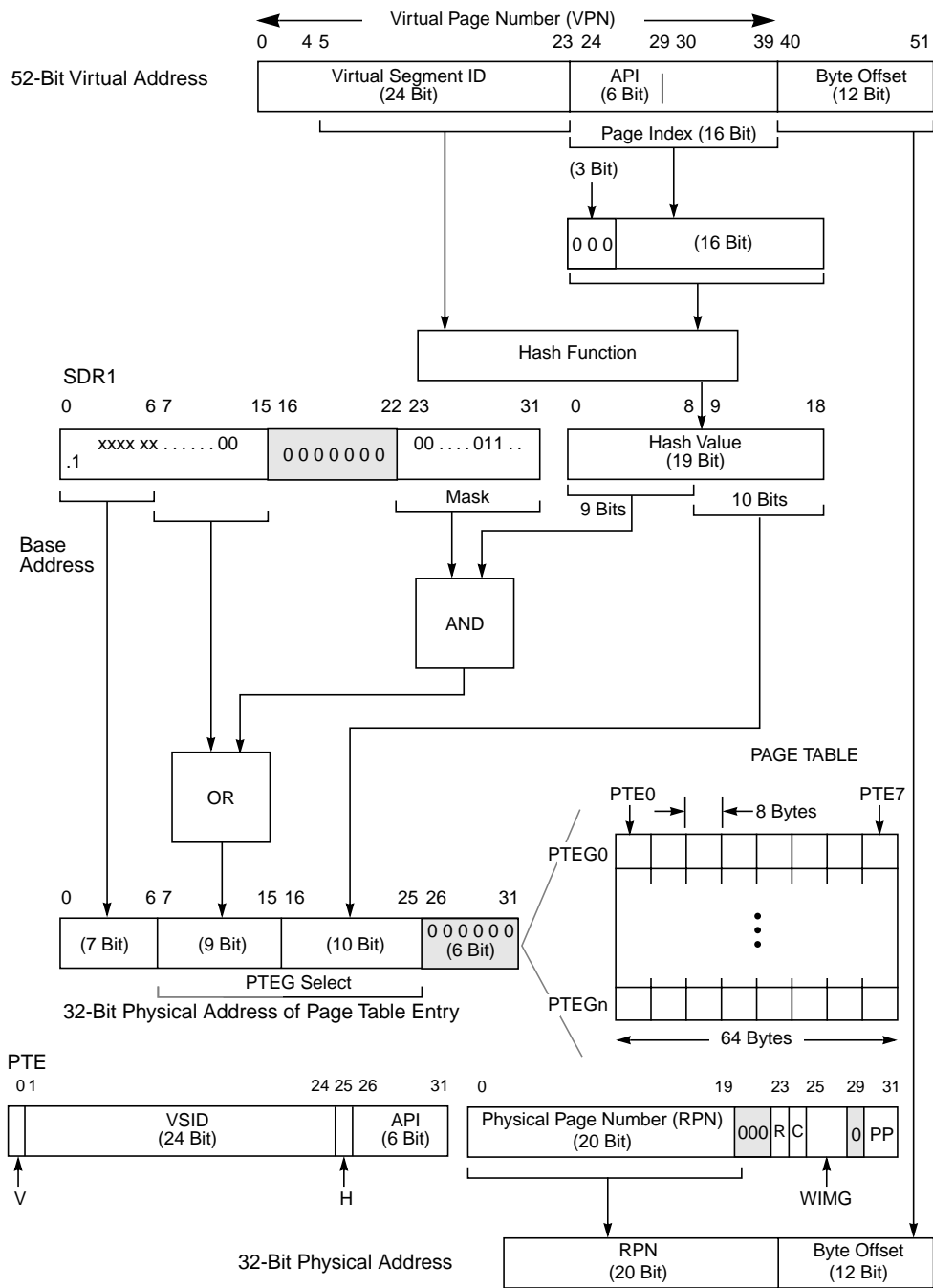

Figure 7-32. Generation of Addresses for Page Tables—32-Bit Implementations

7.6.1.5 Page Table Structure Summary

In the process of searching for a PTE, the processor interprets the values read from memory as described in Section 7.5.2.2, “Page Table Entry (PTE) Definitions.” The VSID and the abbreviated page index (API) fields of the virtual address of the access are compared to those same fields of the PTEs in memory. In addition, the valid (V) bit and the hashing function (H) bit are also checked. For a hit to occur, the V bit of the PTE in memory must be set. If the fields match and the entry is valid, the PTE is considered a hit if the H bit is set as follows:

- If this is the primary PTEG, H = 0
- If this is the secondary PTEG, H = 1

The physical address of the PTE(s) to be checked is derived as shown in Figure 7-31 and Figure 7-32, and the generated address is the address of a group of eight PTEs (a PTEG). During a table search operation, the processor compares up to 16 PTEs: PTE0–PTE7 of the primary PTEG (defined by the primary hashing function) and PTE0–PTE7 of the secondary PTEG (defined by the secondary hashing function).

If the VSID and API fields do not match (or if V or H are not set appropriately) for any of these PTEs, a page fault occurs and an exception is taken. Thus, if a valid PTE is located in the page tables, the page is considered resident; if no matching (and valid) PTE is found for an access, the page in question is interpreted as nonresident (page fault) and the operating system must load the page into main memory and update the PTE accordingly.

The architecture does not specify the order in which the PTEs are checked. Note that for maximum performance however, PTEs should be allocated by the operating system first beginning with the PTE0 location within the primary PTEG, then PTE1, and so on. If more than eight PTEs are required within the address space that defines a PTEG address, the secondary PTEG can be used (again, allocation of PTE0 of the secondary PTEG first, and so on is recommended). Additionally, it may be desirable to place the PTEs that will require most frequent access at the beginning of a PTEG and reserve the PTEs in the secondary PTEG for the least frequently accessed PTEs.

The architecture also allows for multiple matching entries to be found within a table search operation. Multiple matching PTEs are allowed if they meet the match criteria described above, as well as have identical RPN, WIMG, and PP values, allowing for differences in the R and C bits. In this case, one of the matching PTEs is used and the R and C bits are updated according to this PTE. In the case that multiple PTEs are found that meet the match criteria but differ in the RPN, WIMG or PP fields, the translation is undefined and the resultant R and C bits in the matching entries are also undefined.

Note that multiple matching entries can also differ in the setting of the H bit, but the H bit must be set according to whether the PTE was located in the primary or secondary PTEG, as described above.

7.6.1.6 Page Table Structure Examples

The structure of the page tables is very similar for 64- and 32-bit implementations, except that the physical addresses of the PTEGs are 64 bits and 32 bits long for 64- and 32-bit implementations, respectively. Additionally, the size of a PTE for a 64-bit implementation is twice that of a PTE in a 32-bit implementation. Finally, the width of the fields used to generate the PTEG addresses are different (different number of bits used in hashing functions, etc...), and the way in which the size of the page table is specified in the SDR1 register is slightly different.

7.6.1.6.1 Example Page Table for 64-Bit Implementation

Figure 7-33 shows the structure of an example page table for a 64-bit implementation. The base address of the page table is defined by SDR1[HTABORG] concatenated with 18 zero bits. In this example, the address is identified by bits 0–41 in SDR1[HTABORG]; note that bits 42–45 of HTABORG must be zero because the HTABSIZE field specifies an integer mask size of four, which decodes to four mask bits of ones. The addresses for individual PTEGs within this page table are then defined by bits 42–56 as an offset from bits 0–41 of this base address. Thus, the size of the page table is defined as 0x7FFF (32K) PTEGs.

Two example PTEG addresses are shown in the figure as PTEGaddr1 and PTEGaddr2. Bits 42–56 of each PTEG address in this example page table are derived from the output of the hashing function (bits 57–63 are zero to start with PTE0 of the PTEG). In this example, the ‘b’ bits in PTEGaddr2 are the one’s complement of the ‘a’ bits in PTEGaddr1. The ‘n’ bits are also the one’s complement of the ‘m’ bits, but these four bits are generated from bits 24–27 of the output of the hashing function, logically ORed with bits 42–45 of the HTABORG field (which must be zero). If bits 42–56 of PTEGaddr1 were derived by using the primary hashing function, PTEGaddr2 corresponds to the secondary PTEG.

Note, however, that bits 42–56 in PTEGaddr2 can also be derived from a combination of effective address bits, segment descriptor bits, and the primary hashing function. In this case, then PTEGaddr1 corresponds to the secondary PTEG. Thus, while a PTEG may be considered a primary PTEG for some effective addresses (and segment descriptor bits), it may also correspond to the secondary PTEG for a different effective address (and segment descriptor value).

It is the value of the H bit in each of the individual PTEs that identifies a particular PTE as either primary or secondary (there may be PTEs that correspond to a primary PTEG and PTEs that correspond to a secondary PTEG, all within the same physical PTEG address space). Thus, only the PTEs that have $H = 0$ are checked for a hit during a primary PTEG search. Likewise, only PTEs with $H = 1$ are checked in the case of a secondary PTEG search.

Example:
Given: SDR1

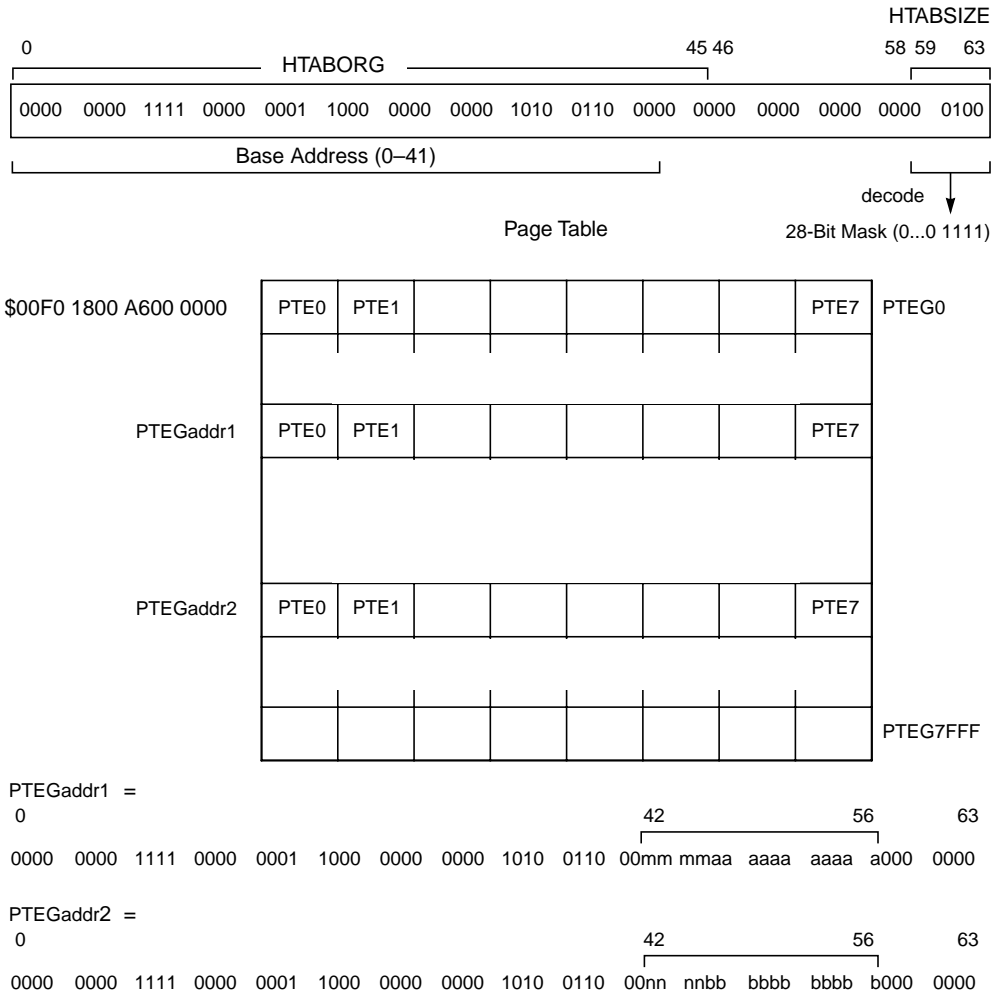

Figure 7-33. Example Page Table Structure—64-Bit Implementations

7.6.1.6.2 Example Page Table for 32-Bit Implementation

Figure 7-34 shows the structure of an example page table for a 32-bit implementation. The base address of the page table is defined by SDR1[HTABORG] concatenated with 16 zero bits. In this example, the address is identified by bits 0–13 in SDR1[HTABORG]; note that bits 14 and 15 of HTABORG must be zero because the lower-order two bits of HTABMASK are ones. The addresses for individual PTEGs within this page table are then

defined by bits 14–25 as an offset from bits 0–13 of this base address. Thus, the size of the page table is defined as 4096 PTEGs.

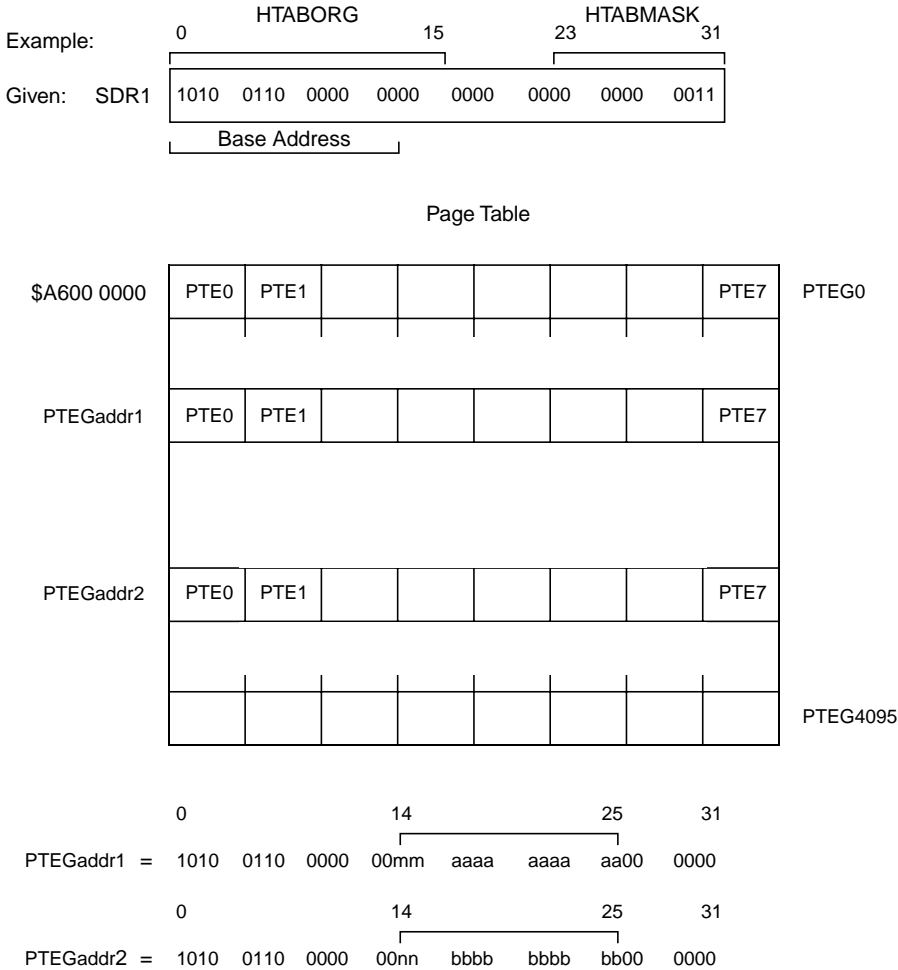

Figure 7-34. Example Page Table Structure—32-Bit Implementations

Two example PTEG addresses are shown in the figure as PTEGaddr1 and PTEGaddr2. Bits 14–25 of each PTEG address in this example page table are derived from the output of the hashing function (bits 26–31 are zero to start with PTE0 of the PTEG). In this example, the ‘b’ bits in PTEGaddr2 are the one’s complement of the ‘a’ bits in PTEGaddr1. The ‘n’ bits are also the one’s complement of the ‘m’ bits, but these two bits are generated from bits 7–8 of the output of the hashing function, logically ORed with bits 14–15 of the HTABORG field (which must be zero). If bits 14–25 of PTEGaddr1 were derived by using the primary hashing function, then PTEGaddr2 corresponds to the secondary PTEG.

Note, however, that bits 14–25 in PTEGaddr2 can also be derived from a combination of effective address bits, segment register bits, and the primary hashing function. In this case, then PTEGaddr1 corresponds to the secondary PTEG. Thus, while a PTEG may be considered a primary PTEG for some effective addresses (and segment register bits), it may also correspond to the secondary PTEG for a different effective address (and segment register value).

It is the value of the H bit in each of the individual PTEs that identifies a particular PTE as either primary or secondary (there may be PTEs that correspond to a primary PTEG and PTEs that correspond to a secondary PTEG, all within the same physical PTEG address space). Thus, only the PTEs that have $H = 0$ are checked for a hit during a primary PTEG search. Likewise, only PTEs with $H = 1$ are checked in the case of a secondary PTEG search.

7.6.1.7 PTEG Address Mapping Examples

This section contains two examples of an effective address and how its address translation (the PTE) maps into the primary PTEG in physical memory. The examples illustrate how the processor generates PTEG addresses for a table search operation; this is also the algorithm that must be used by the operating system in creating page tables. There is one example for a 64-bit implementation and a second example for a 32-bit implementation.

7.6.1.7.1 PTEG Address Mapping Example—64-Bit Implementation

In the example shown in Figure 7-35, the value in SDR1 defines a page table at address `0x0F05_8400_0F00_0000` that contains 2^{17} PTEGs. The highest order 36 bits of the effective address uniquely map to a segment descriptor. The segment descriptor is then located and the contents of the segment descriptor are used along with bits 36–63 of the effective address to create the 80-bit virtual address.

To generate the address of the primary PTEG, bits 13–51, and bits 52–67 of the virtual address are then used as inputs into the primary hashing function (XOR) to generate hash value 1. The low-order 17 bits of hash value 1 are then concatenated with the high-order 40 bits of HTABORG and with seven low-order 0 bits, defining the address of the primary PTEG (`0x0F05_8400_0F3F_F300`). The ANDing of the 28 high-order bits of hash value 1 with the mask (defined by the HTABSIZE field) and the ORing with bits 18–45 of HTABORG are implicitly shown in the figure. The ANDing with the mask selects six additional bits of hash value 1 to be used (in addition to the 11 prescribed bits) producing a total of 17 bits of hash value 1 bits to be used. The ORing causes those selected six bits of hash value 1 to comprise bits 40–45 of the PTEG address (as bits 40–45 of HTABORG should be zero).

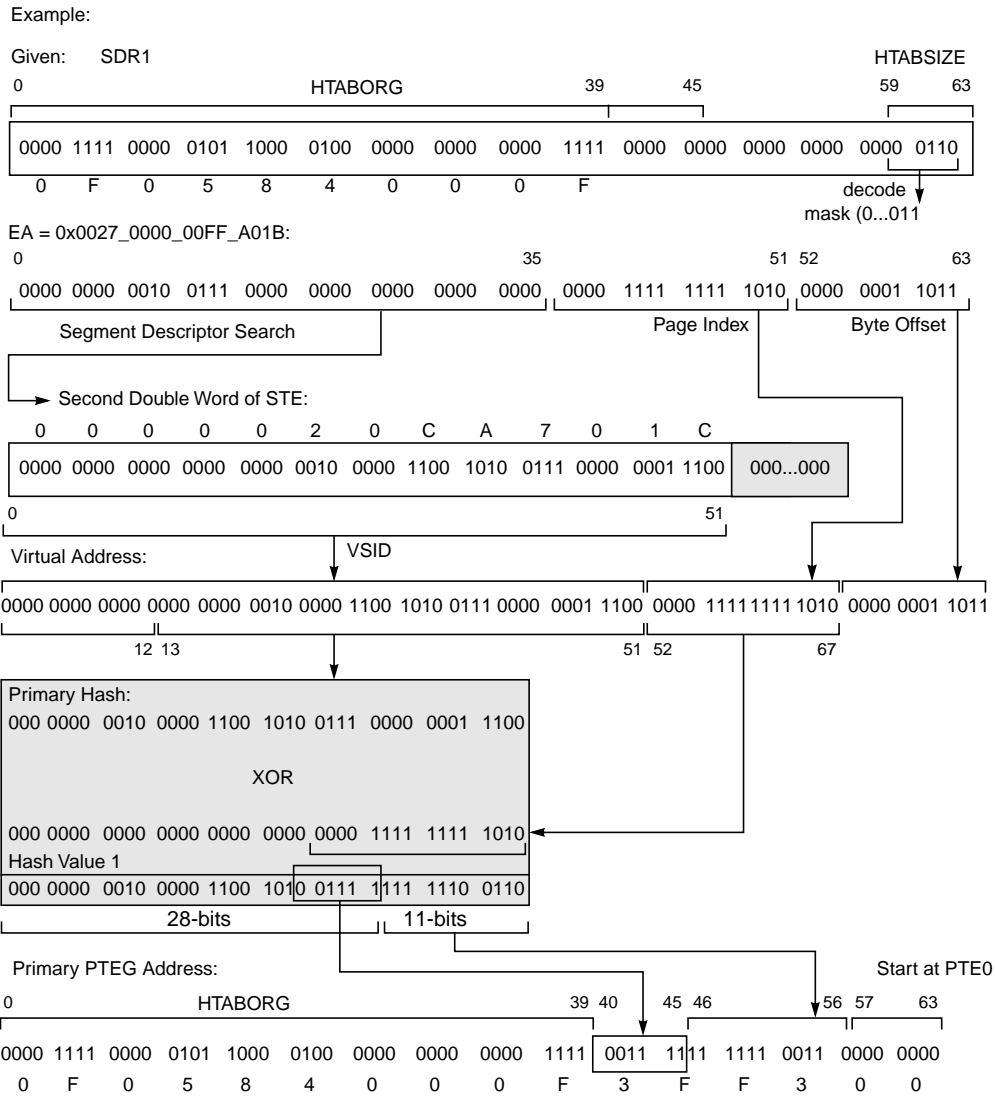

Figure 7-35. Example Primary PTEG Address Generation—64-Bit Implementation

Figure 7-36 shows the generation of the secondary PTEG address for this example. If the secondary PTEG is required, the secondary hash function is performed and the low-order 17 bits of hash value 2 are then ORed with the high-order 46 bits of HTABORG (bits 40–45 should be zero), and concatenated with seven low-order 0 bits, defining the address of the secondary PTEG (0x0F05_8400_0FC0_0C80).

As described in Figure 7-31, the 11 low-order bits of the page index field are always used in the generation of a PTEG address (through the hashing function). This is why only the 5-bit abbreviated page index (API) is defined for a PTE (the entire page index field does not need to be checked). For a given effective address, the low-order 11 bits of the page index (at least) contribute to the PTEG address (both primary and secondary) where the corresponding PTE may reside in memory. Therefore, if the high-order 5 bits (the API field) of the page index match with the API field of a PTE within the specified PTEG, the PTE mapping is guaranteed to be the unique PTE required.

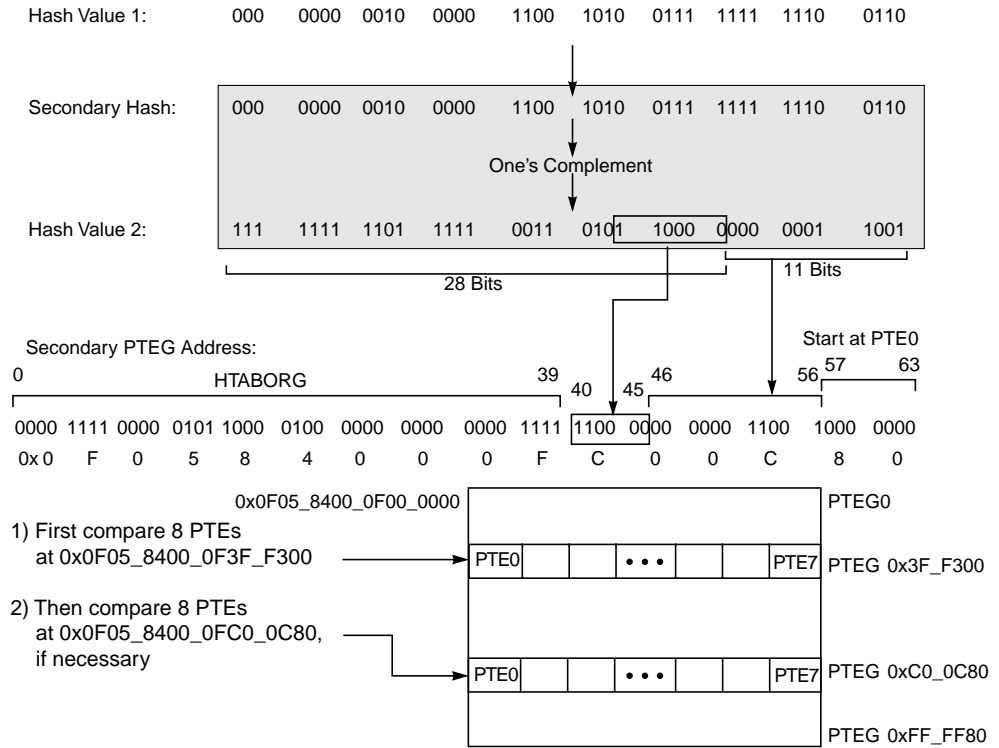

Figure 7-36. Example Secondary PTEG Address Generation—64-Bit Implementation

Note that a given PTEG address does not map back to a unique effective address. Not only can a given PTEG be considered both a primary and a secondary PTEG (as described in Section 7.6.1.6, “Page Table Structure Examples”), but if the mask defined has four 1 bits or less (not the case shown in the example in the figure), some bits of the page index field of the virtual address are not used to generate the PTEG address. Therefore, any combination of these unused bits will map to the same pair of PTEG addresses. (However, these bits are part of the API and are therefore compared for each PTE within the PTEG to

determine if there is a hit.) Furthermore, an effective address can select a different segment descriptor with a different value such that the output of the primary (or secondary) hashing function happens to equal the hash values shown in the example. Thus, these effective addresses would also map to the same PTEG addresses shown.

7.6.1.7.2 PTEG Address Mapping Example—32-Bit Implementation

Figure 7-37 shows an example of PTEG address generation for a 32-bit implementation. In the example, the value in SDR1 defines a page table at address 0x0F98_0000 that contains 8192 PTEGs. The example effective address selects segment register 0 (SR0) with the highest order four bits. The contents of SR0 are then used along with bits 4–31 of the effective address to create the 52-bit virtual address.

To generate the address of the primary PTEG, bits 5–23, and bits 24–39 of the virtual address are then used as inputs into the primary hashing function (XOR) to generate hash value 1. The low-order 13 bits of hash value 1 are then concatenated with the high-order 16 bits of HTABORG and with six low-order 0 bits, defining the address of the primary PTEG (0x0F9F_F980). The ANDing of the nine high-order bits of hash value 1 with the value in the HTABMASK field and the ORing with bits 7–15 of HTABORG are implicitly shown in the figure. The ANDing with the mask selects three additional bits of hash value 1 to be used (in addition to the 10 prescribed bits) producing a total of 13 bits of hash value 1 bits to be used. The ORing causes those selected three bits of hash value 1 to comprise bits 13–15 of the PTEG address (as bits 13–15 of HTABORG should be zero).

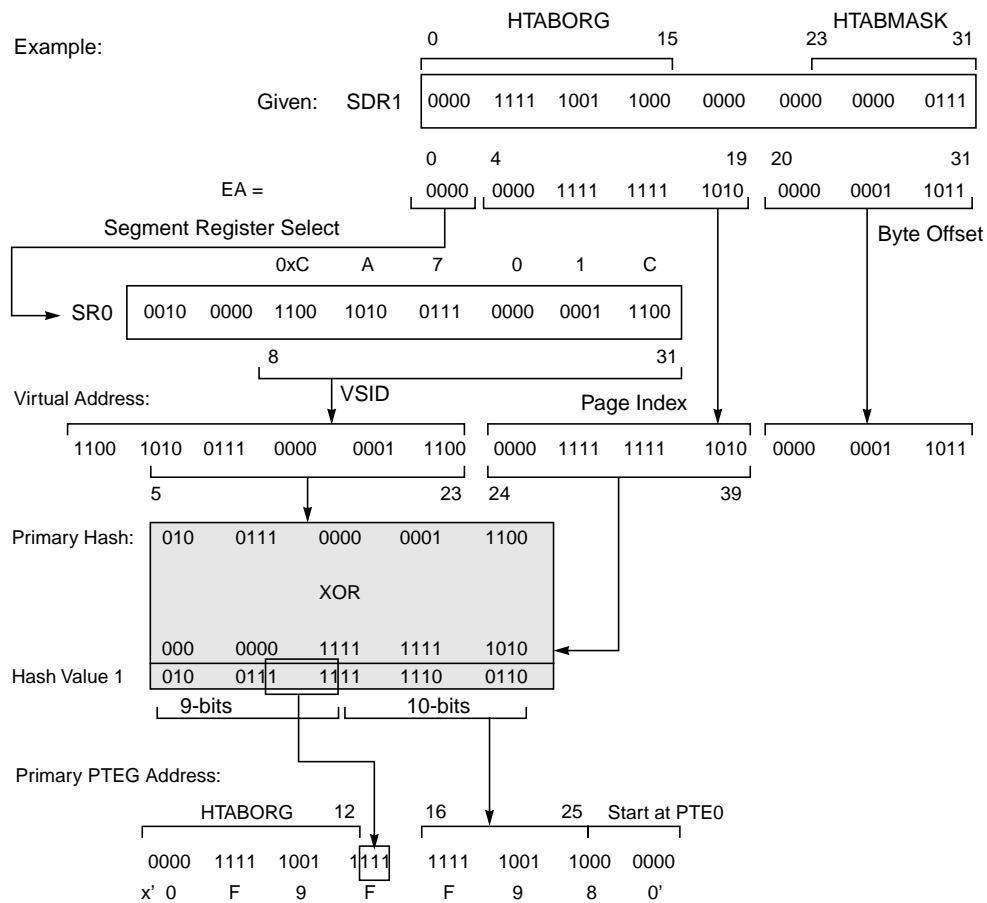

Figure 7-37. Example Primary PTEG Address Generation—32-Bit Implementation

Figure 7-38 shows the generation of the secondary PTEG address for this example. If the secondary PTEG is required, the secondary hash function is performed and the low-order 13 bits of hash value 2 are then ORed with the high-order 16 bits of HTABORG (bits 13–15 should be zero), and concatenated with six low-order 0 bits, defining the address of the secondary PTEG (0x0F98_0640).

As described in Figure 7-32, the 10 low-order bits of the page index field are always used in the generation of a PTEG address (through the hashing function) for a 32-bit implementation. This is why only the abbreviated page index (API) is defined for a PTE (the entire page index field does not need to be checked). For a given effective address, the low-order 10 bits of the page index (at least) contribute to the PTEG address (both primary and secondary) where the corresponding PTE may reside in memory. Therefore, if the high-

order 6 bits (the API field as defined for 32-bit implementations) of the page index match with the API field of a PTE within the specified PTEG, the PTE mapping is guaranteed to be the unique PTE required.

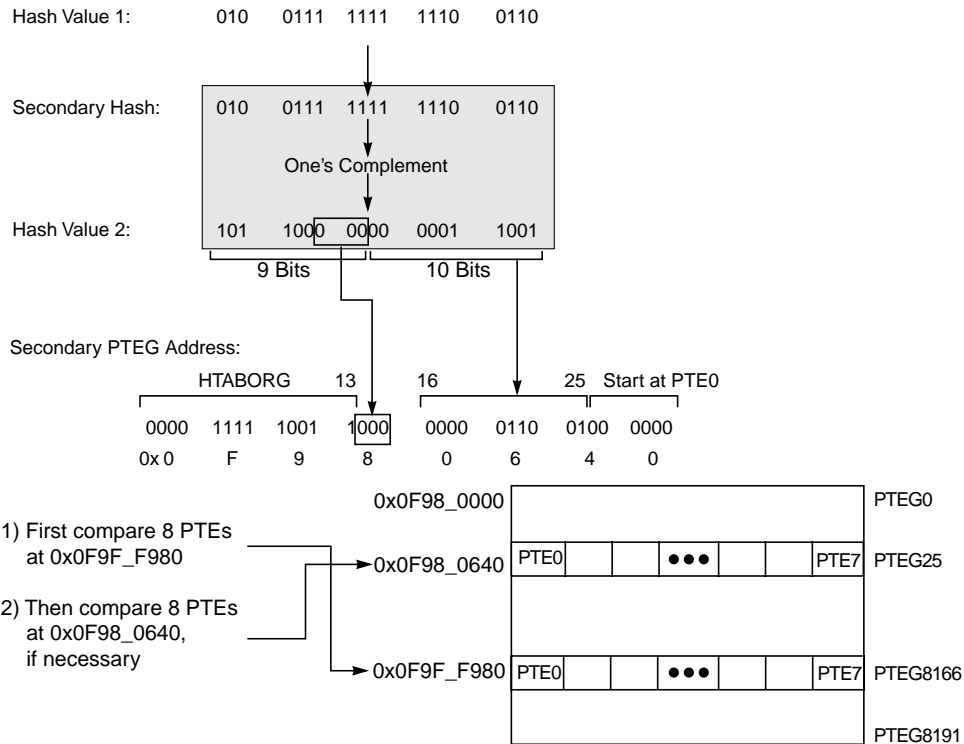

Figure 7-38. Example Secondary PTEG Address Generation—32-Bit Implementations

Note that a given PTEG address does not map back to a unique effective address. Not only can a given PTEG be considered both a primary and a secondary PTEG (as described in Section 7.6.1.6, “Page Table Structure Examples”), but in this example, bits 24–26 of the page index field of the virtual address are not used to generate the PTEG address. Therefore, any of the eight combinations of these bits will map to the same primary PTEG address. (However, these bits are part of the API and are therefore compared for each PTE within the PTEG to determine if there is a hit.) Furthermore, an effective address can select a different segment register with a different value such that the output of the primary (or secondary) hashing function happens to equal the hash values shown in the example. Thus, these effective addresses would also map to the same PTEG addresses shown.

7.6.2 Page Table Search Operation

The table search process performed by a PowerPC processor in the search of a PTE varies slightly for 64- and 32-bit implementations. The main differences are the address ranges and PTE formats specified.

7.6.2.1 Page Table Search Operation for 64-Bit Implementations

An outline of the page table search process performed by a 64-bit implementation is as follows:

1. The 64-bit physical addresses of the primary and secondary PTEGs are generated as described in Section 7.6.1.4.1, “Page Table Address Generation for 64-Bit Implementations.”
2. As many as 16 PTEs (from the primary and secondary PTEGs) are read from memory (the architecture does not specify the order of these reads, allowing multiple reads to occur in parallel). PTE reads occur with an implied WIM memory/cache mode control bit setting of 0b001. Therefore, they are considered cacheable.
3. The PTEs in the selected PTEGs are tested for a match with the virtual page number (VPN) of the access. The VPN is the VSID concatenated with the page index field of the virtual address. For a match to occur, the following must be true:
 - PTE[H] = 0 for primary PTEG; PTE[H] = 1 for secondary PTEG
 - PTE[V] = 1
 - PTE[VSID] = VA[0-51]
 - PTE[API] = VA[52-56]
4. If a match is not found within the eight PTEs of the primary PTEG and the eight PTEs of the secondary PTEG, an exception is generated as described in step 8. If a match (or multiple matches) is found, the table search process continues.
5. If multiple matches are found, all of the following must be true:
 - PTE[RPN] is equal for all matching entries
 - PTE[WIMG] is equal for all matching entries
 - PTE[PP] is equal for all matching entries
6. If one of the fields in step 5 does not match, the translation is undefined, and R and C bit of matching entries are undefined. Otherwise, the R and C bits are updated based on one of the matching entries.
7. A copy of the PTE is written into the on-chip TLB (if implemented) and the R bit is updated in the PTE in memory (if necessary). If there is no memory protection violation, the C bit is also updated in memory (if necessary) and the table search is complete.
8. If a match is not found within the primary or secondary PTEG, the search fails, and a page fault exception condition occurs (either an ISI or DSI exception).

Reads from memory for page table search operations are performed as if the WIMG bit settings were 0b0010 (that is, as unguarded cacheable operations in which coherency is required).

7.6.2.2 Page Table Search Operation for 32-Bit Implementations

An outline of the page table search process performed by a 32-bit implementation is as follows:

1. The 32-bit physical addresses of the primary and secondary PTEGs are generated as described in Section 7.6.1.4.2, “Page Table Address Generation for 32-Bit Implementations.”
2. As many as 16 PTEs (from the primary and secondary PTEGs) are read from memory (the architecture does not specify the order of these reads, allowing multiple reads to occur in parallel). PTE reads occur with an implied WIM memory/cache mode control bit setting of 0b001. Therefore, they are considered cacheable.
3. The PTEs in the selected PTEGs are tested for a match with the virtual page number (VPN) of the access. The VPN is the VSID concatenated with the page index field of the virtual address. For a match to occur, the following must be true:
 - PTE[H] = 0 for primary PTEG; PTE[H] = 1 for secondary PTEG
 - PTE[V] = 1
 - PTE[VSID] = VA[0–23]
 - PTE[API] = VA[24–29]
4. If a match is not found within the eight PTEs of the primary PTEG and the eight PTEs of the secondary PTEG, an exception is generated as described in step 8. If a match (or multiple matches) is found, the table search process continues.
5. If multiple matches are found, all of the following must be true:
 - PTE[RPN] is equal for all matching entries
 - PTE[WIMG] is equal for all matching entries
 - PTE[PP] is equal for all matching entries
6. If one of the fields in step 5 does not match, the translation is undefined, and R and C bit of matching entries are undefined. Otherwise, the R and C bits are updated based on one of the matching entries.
7. A copy of the PTE is written into the on-chip TLB (if implemented) and the R bit is updated in the PTE in memory (if necessary). If there is no memory protection violation, the C bit is also updated in memory (if necessary) and the table search is complete.
8. If a match is not found within the primary or secondary PTEG, the search fails, and a page fault exception condition occurs (either an ISI or DSI exception).

Reads from memory for page table search operations are performed as if the WIMG bit settings were 0b0010 (that is, as unguarded cacheable operations in which coherency is required).

7.6.2.3 Flow for Page Table Search Operation

Figure 7-39 provides a detailed flow diagram of a page table search operation. Note that the references to TLBs are shown as optional because TLBs are not required; if they do exist, the specifics of how they are maintained are implementation-specific. Also, Figure 7-39 shows only a few cases of R-bit and C-bit updates. For a complete list of the R- and C-bit updates dictated by the architecture, refer to Table 7-20.

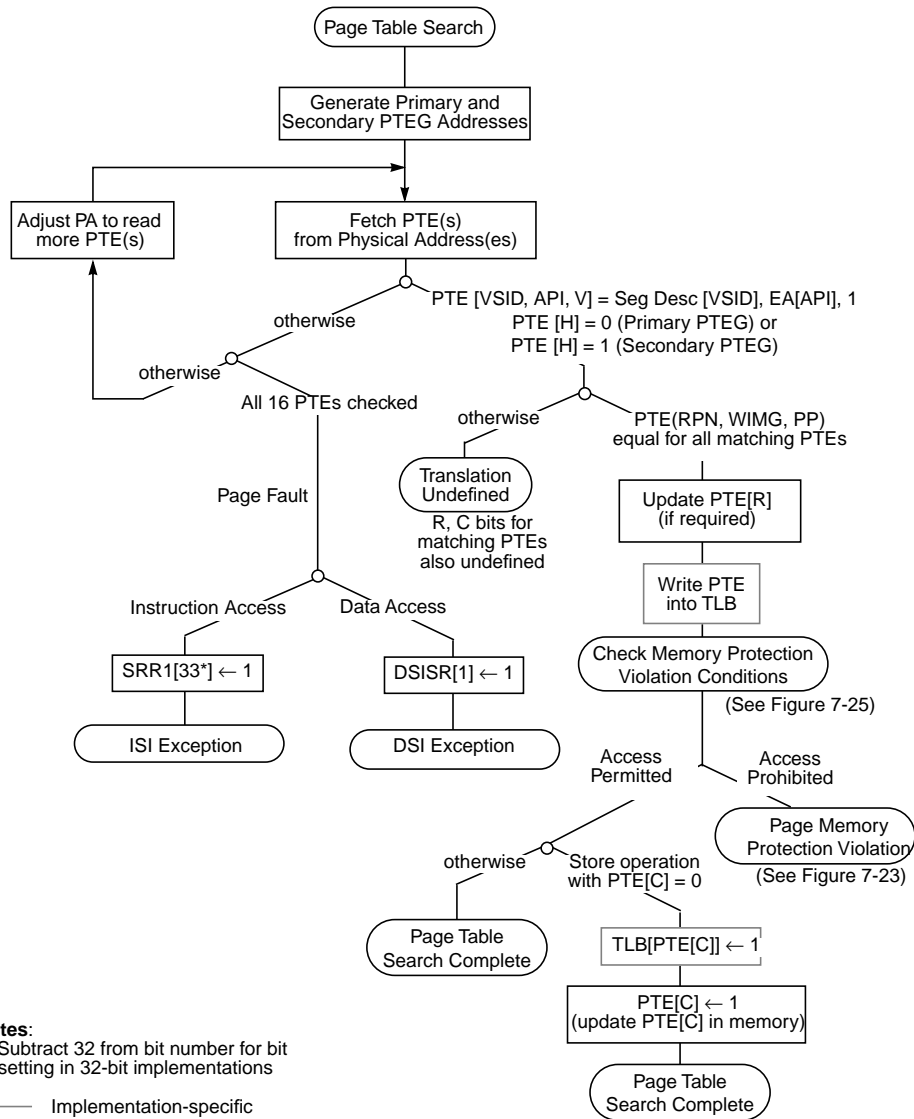

Figure 7-39. Page Table Search Flow

7.6.3 Page Table Updates

This section describes the requirements on the software when updating page tables in memory via some pseudocode examples. Multiprocessor systems must follow the rules described in this section so that all processors operate with a consistent set of page tables. Even single processor systems must follow certain rules, because software changes must be synchronized with the other instructions in execution and with automatic updates that may be made by the hardware (referenced and changed bit updates). Updates to the tables include the following operations:

- Adding a PTE
- Modifying a PTE, including modifying the R and C bits of a PTE
- Deleting a PTE

PTEs must be locked on multiprocessor systems. Access to PTEs must be appropriately synchronized by software locking of (that is, guaranteeing exclusive access to) PTEs or PTEGs if more than one processor can modify the table at that time. In the examples below, software locks should be performed to provide exclusive access to the PTE being updated. However, the architecture does not dictate the specific protocol to be used for locking (for example, a single lock, a lock per PTEG, or a lock per PTE can be used). See Appendix E, “Synchronization Programming Examples,” for more information about the use of the reservation instructions (such as the **lwarx** and **stwcx** instructions) to perform software locking.

When TLBs are implemented they are defined as noncoherent caches of the page tables. TLB entries must be invalidated explicitly with the TLB invalidate entry instruction (**tlbie**) whenever the corresponding PTE is modified. In a multiprocessor system, the **tlbie** instruction must be controlled by software locking, so that the **tlbie** is issued on only one processor at a time.

The PowerPC OEA defines the **tlbsync** instruction that ensures that TLB invalidate operations executed by this processor have caused all appropriate actions in other processors. In a system that contains multiple processors, the **tlbsync** functionality must be used in order to ensure proper synchronization with the other PowerPC processors. Note that a **sync** instruction must also follow the **tlbsync** to ensure that the **tlbsync** has completed execution on this processor.

On single processor systems, PTEs need not be locked and the **eiemo** instructions (in between the **tlbie** and **tlbsync** instructions) and the **tlbsync** instructions themselves are not required. The **sync** instructions shown are required even for single processor systems (to ensure that all previous changes to the page tables and all preceding **tlbie** instructions have completed).

Any processor, including the processor modifying the page table, may access the page table at any time in an attempt to reload a TLB entry. An inconsistent PTE must never accidentally become visible (if $V = 1$); thus, there must be synchronization between modifications to the valid bit and any other modifications (to avoid corrupted data).

In the pseudocode examples that follow, changes made to a PTE or STE shown as a single line in the example is assumed to be performed with an atomic store instruction. Appropriate modifications must be made to these examples if this assumption is not satisfied (for example, if a store double-word operation on a 64-bit implementation is performed with two store word instructions).

Updates of R and C bits by the processor are not synchronized with the accesses that cause the updates. When modifying the low-order half of a PTE, software must take care to avoid overwriting a processor update of these bits and to avoid having the value written by a store instruction overwritten by a processor update. The processor does not alter any other fields of the PTE.

Explicitly altering certain MSR bits (using the **mtmsrd** instruction), or explicitly altering STEs, PTEs, or certain system registers, may have the side effect of changing the effective or physical addresses from which the current instruction stream is being fetched. This kind of side effect is defined as an implicit branch. For example, an **mtmsrd** instruction may change the value of MSR[SF], changing the effective addresses from which the current instruction stream is being fetched, causing an implicit branch. Implicit branches are not supported and an attempt to perform one causes boundedly-undefined results. Therefore, PTEs and STEs must not be changed in a manner that causes an implicit branch. Section 2.3.18, “Synchronization Requirements for Special Registers and for Lookaside Buffers,” lists the possible implicit branch conditions that can occur when system registers and MSR bits are changed.

For a complete list of the synchronization requirements for executing the MMU instructions, see Section 2.3.18, “Synchronization Requirements for Special Registers and for Lookaside Buffers.”

The following examples show the required sequence of operations. However, other instructions may be interleaved within the sequences shown.

7.6.3.1 Adding a Page Table Entry

Adding a page table entry requires only a lock on the PTE in a multiprocessor system. The first bytes in the PTE are then written (this example assumes the old valid bit was cleared), the **eiio** instruction orders the update, and then the second update can be made. A **sync** instruction ensures that the updates have been made to memory.

```
lock(PTE)
PTE[RPN,R,C,WIMG,PP] ← new values
eiio          /* order 1st PTE update before 2nd
PTE[VSID,H,API,V] ← new values (V = 1)
sync        /* ensure updates completed
unlock(PTE)
```

7.6.3.2 Modifying a Page Table Entry

This section describes several scenarios for modifying a PTE.

7.6.3.2.1 General Case

Consider the general case where a currently-valid PTE must be changed. To do this, the PTE must be locked, marked invalid, updated, invalidated from the TLB, marked valid again, and unlocked. The **sync** instruction must be used at appropriate times to wait for modifications to complete.

Note that the **tlbsync** and the **sync** instruction that follows it are only required if software consistency must be maintained with other PowerPC processors in a multiprocessor system (and the software is to be used in a multiprocessor environment).

```
lock(PTE)
PTE[V] ← 0          /* (other fields don't matter)
sync                /* ensure update completed
PTE[RPN,R,C,WIMG,PP] ← new values
tlbie(old_EA)      /*invalidate old translation
eiio              /* order    before tlbsync and order 2nd PTE update before 3rd
PTE[VSID,H,API, V] ← new values (V = 1)
tlbsync           /* ensure tlbie completed on all processors
sync              /* ensure tlbsync and last update completed
unlock(PTE)
```

7.6.3.2.2 Clearing the Referenced (R) Bit

When the PTE is modified only to clear the R bit to 0, a much simpler algorithm suffices because the R bit need not be maintained exactly.

```
lock(PTE)
oldR ← PTE[R]      /*get old R
if oldR = 1, then
    PTE[R] ← 0     /* store byte (R = 0, other bits unchanged)
    tlbie(PTE)     /* invalidate entry
    eiio          /* order tlbie before tlbsync
    tlbsync       /* ensure tlbie completed on all processors
    sync         /* ensure tlbsync and update completed
unlock(PTE)
```

Since only the R and C bits are modified by the processor, and since they reside in different bytes, the R bit can be cleared by reading the current contents of the byte in the PTE containing R (bits 48–55 of the second double word, or bits 16–23 of the second word for 64- and 32-bit implementations, respectively), ANDing the value with 0xFE, and storing the byte back into the PTE.

7.6.3.2.3 Modifying the Virtual Address

If the virtual address is being changed to a different address within the same hash class (primary or secondary), the following flow suffices:

```
lock(PTE)
PTE[VSID,API,H,V] ← new values (V = 1)
  sync          /* ensure update completed
  tlbie(old_EA) /* invalidate old translation
  eieio        /* order tlbie before tlbsync
  tlbsync     /* ensure tlbie completed on all processors
  sync        /* ensure tlbsync completed
unlock(PTE)
```

In this pseudocode flow, note that the store into the first double word (for 64-bit implementations) of the PTE is performed atomically. Also, the **tlbsync** and the **sync** instruction that follows it are only required if consistency must be maintained with other PowerPC processors in a multiprocessor system (and the software is to be used in a multiprocessor environment).

In this example, if the new address is not a cache synonym (alias) of the old address, care must be taken to also flush (or invalidate) from an on-chip cache any cache synonyms for the page. Thus, a temporary virtual address that is a cache synonym with the page whose PTE is being modified can be assigned and then used for the cache flushing (or invalidation).

To modify the WIMG or PP bits without overwriting an R or C bit update being performed by the processor, a sequence similar to the one shown above can be used, except that the second line is replaced by a loop containing an **lwarx/stwcx**. instruction pair that emulates an atomic compare and swap of the low-order word of the PTE.

7.6.3.3 Deleting a Page Table Entry

In this example, the entry is locked, marked invalid, invalidated in the TLB, and unlocked.

Again, note that the **tlbsync** and the **sync** instruction that follows it are only required if consistency must be maintained with other PowerPC processors in a multiprocessor system (and the software is to be used in a multiprocessor environment).

```
lock(PTE)
PTE[V] ← 0          /* (other fields don't matter)
sync              /* ensure update completed
tlbie(old_EA)    /* invalidate old translation
eieio           /* order tlbie before tlbsync
tlbsync        /* ensure tlbie completed on all processors
sync           /* ensure tlbsync completed
unlock(PTE)
```

7.6.4 ASR and Segment Register Updates

There are certain synchronization requirements for writing to the ASR or using the move to segment register instructions. These are described in Section 2.3.18, “Synchronization Requirements for Special Registers and for Lookaside Buffers.”

7.7 Hashed Segment Tables—64-Bit Implementations

Throughout this chapter, the segment information for an access in a 64-bit implementation has been referenced as residing in a segment descriptor. Whereas the segment descriptors reside in on-chip registers for 32-bit implementations, the segment descriptors for 64-bit implementations reside as segment table entries (STEs) in a hashed segment table in memory, analogous to the hashed page tables for PTEs. Also, similar to the optional storing of recently-used PTEs on-chip in a TLB, copies of STEs may optionally be stored in one or more on-chip segment lookaside buffers (SLBs), for quicker access. Additionally, the hardware may optionally provide dedicated hardware to search the segment table for an STE automatically, or the processor may vector to an exception routine so that the segment table can be searched by the exception handler software when an STE is required. Note that the algorithm for a segment table search operation must be synthesized by the operating system for it to correctly place the STEs in main memory.

If segment table search operations are performed automatically by the hardware, they are performed as if the WIMG bit settings were 0b0010 (that is, as unguarded cacheable operations in which coherency is required). Unlike the page tables, note that the segment table is never updated automatically by the hardware as a side effect of address translation. If the software performs the segment table search operations, the accesses must be performed in real addressing mode ($MSR[DR] = 0$); this additionally guarantees that $M = 1$.

This section describes the format of segment tables and the algorithm used to access them. In addition, the constraints imposed on the software in updating the segment tables are described.

TEMPORARY 64-BIT BRIDGE

Because the 64-bit bridge provides access only to 32-bit address space, the entire 4 Gbytes of effective address space can be defined with 16 on-chip segment descriptors, each defining a 256-Mbyte segment.

7.7.1 Segment Table Definition

A segment table is a 4-Kbyte (one page) data structure that defines the mapping between effective segments and virtual segments for a process. The segment table must reside on a page boundary, and must reside in memory with the WIMG attributes of 0b0010. Whereas at any given time the processor can address only the segments that are defined in a particular segment table, many segment tables can exist in memory, and each one can correspond to a unique process. Physical addresses for elements in the active segment table are derived

from the value in the address space register (ASR) and some hashed bits of the effective address.

The segment table contains a number of segment table entry groups (STEGs). An STEG contains eight segment table entries (STEs) of 16 bytes each; therefore, each STEG is 128 bytes long. STEG addresses are entry points for segment table search operations. Figure 7-40 shows two STEG addresses (STEGaddr1 and STEGaddr2) where a given STE may reside.

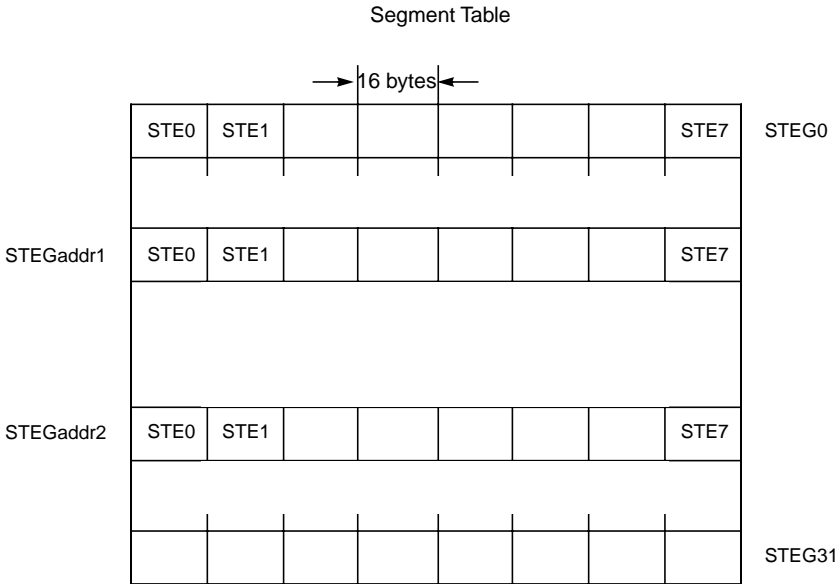

Figure 7-40. Segment Table Definitions

A given STE can reside in one of two possible STEGs. For each STEG address, there is a complementary STEG address—one is the primary STEG and the other is the secondary STEG. Additionally, a given STE can reside in any of the STE locations within an addressed STEG. Thus, a given STE may reside in one of 16 possible locations within the segment table. If a given STE is not resident within either the primary or secondary STEG, a segment table miss occurs, possibly corresponding to a segment fault condition.

A segment table search operation is defined as the search for an STE within a primary and secondary STEG. When a segment table search operation commences, the primary and secondary hashing functions are performed on the effective address. The output of the hashing functions are then concatenated with bits programmed into the ASR by the operating system to create the physical addresses of the primary and secondary STEGs. The STEs in the STEGs are then checked to see if there is a hit within one of the STEGs.

Note, however, that although a given STE may reside in one of 16 possible locations, an address that is a primary STEG address for some accesses also functions as a secondary STEG address for a second set of accesses (as defined by the secondary hashing function). Therefore, these 16 possible locations are really shared by two different sets of effective addresses. Section 7.7.1.5, “Segment Table Structure (with Examples),” illustrates how STEs map into the 16 possible locations as primary and secondary STEs.

7.7.1.1 Address Space Register (ASR)

The ASR contains the control information for the segment table structure in that it defines the highest-order bits for the physical base address of the segment table. The format of the ASR is shown in Figure 7-41. The ASR contains bits 0–51 of the 64-bit physical base address of the segment table. Bits 52–56 of the STEG address are derived from the hashing function, and bits 57–63 are zero at the beginning of a segment table search operation to point to the beginning of an STEG. Therefore, the beginning of the segment table lies on a 2¹² byte (4 Kbyte) boundary.

Note that unless all accesses to be performed by the processor can be translated by the BAT mechanism when address translation is enabled (MSR[DR] or MSR[IR] = 1), the ASR must point to a valid segment table. If the processor does not support 64 bits of physical address, software should write zeros to those unsupported bits in the ASR (as the implementation treats them as reserved). Otherwise, a machine check exception can occur.

Additionally, care should be given that segment table addresses not conflict with those that correspond to areas of the physical address map reserved for the exception vector table or other implementation-specific purposes (refer to Section 7.2.1.2, “Predefined Physical Memory Locations”). Note that there are certain synchronization requirements for writing to the ASR that are described in Section 2.3.18, “Synchronization Requirements for Special Registers and for Lookaside Buffers.”

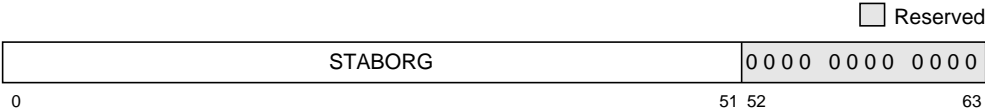

Figure 7-41. ASR Format—64-Bit Implementations Only

The STABORG field identifies the 52-bit physical address of the segment table. The remaining bits are reserved.

TEMPORARY 64-BIT BRIDGE

The OEA defines an additional, optional bridge to the 64-bit architecture that allows 64-bit implementations to retain certain aspects of the 32-bit architecture that otherwise are not supported, and in some cases not permitted by the 64-bit architecture. In processors that implement this bridge, at least 16 STEs are implemented and are maintained in 16 dedicated SLB entries.

The bridge facilities allow the option of defining bit 63 as ASR[V], the STABORG field valid bit. If this bit is implemented, STABORG is valid only when ASR[V] is set. This bit is optional, but is implemented if any of the following instructions, which are optional to a 64-bit processor, are implemented: **mtsr**, **mtsrin**, **mfsr**, **mfsrin**, **mtsrđ**, or **mtsrđin**. If the bit is not implemented it is treated as reserved except that it is assumed to be 1 for address translation.

The following further describes programming considerations that are affected by the ASR[V] bit:

- If ASR[V] is cleared, having the STABORG field refer to a nonexistent memory location does not cause a machine check exception. Also, if ASR[V] is cleared, the segment table in memory is not searched and the result is the same as if the search had failed.
- For a 64-bit operating system that uses the segment register manipulation instructions as if it were running on a 32-bit implementation, if ASR[V] = 0, a segment fault can occur only if the operating system contains a bug that allows the generation of an effective address larger than $2^{32} - 1$ when MSR[SF] = 1 or if the operating system fails to ensure that the first 16 ESIDs are established (that is, the corresponding SLB entries are valid)
- Note that **slbie** or **slbia** can be executed regardless of the setting of ASR[V]; however, the instructions should not be used if ASR[V] is cleared.

If ASR[V] is implemented, the ASR must point to a valid segment table whenever address translation is enabled, the effective address is not covered by BAT translation, and ASR[V] = 1.

7.7.1.2 Segment Table Hashing Functions

The MMU uses two different hashing functions, a primary and a secondary, in the creation of the physical addresses used in a segment table search operation. These hashing functions distribute the STEs within the segment table, in that there are two possible STEGs where a given STE can reside. Additionally, there are eight possible STE locations within an STEG where a given STE can reside. If an STE is not found using the primary hashing function, the secondary hashing function is performed, and the secondary STEG is searched. Note that these two functions must also be used by the operating system to set up the segment tables in memory appropriately.

Typically, the hashing functions provide a high probability that a required STE is resident in the segment table, without requiring the definition of all possible STEs in main memory. However, if an STE is not found in the secondary STEG, an exception is taken. Thus, the required STE can then be placed into either the primary or secondary STEG by the system software, and on the next SLB miss to this segment (in those processors that implement an SLB), the STE will be found.

The address of an STEG is derived from the base address specified in the ASR, and the output of the corresponding hashing function (primary hashing function for primary STEG and secondary hashing function for a secondary STEG).

Figure 7-42 depicts the hashing functions used by the PowerPC OEA for segment tables. The input to the primary hashing function is the lower-order 5 bits of the ESID field of the effective address. This value is also defined as the output of the primary hashing function (hash value 1).

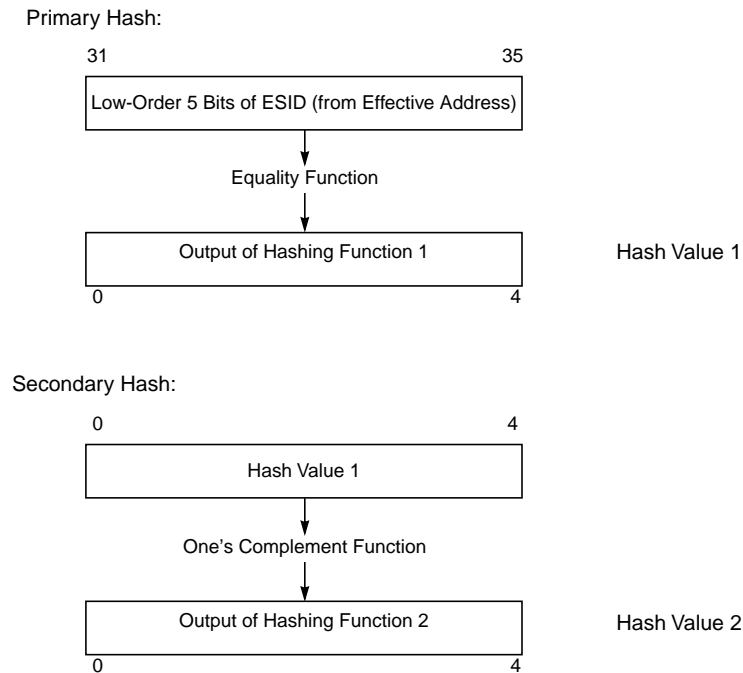

Figure 7-42. Hashing Functions for Segment Tables

When the secondary hashing function is required, the output of the primary hashing function is the one's complement, to provide hash value 2.

TEMPORARY 64-BIT BRIDGE

Note that although processors using the 64-bit bridge implement STEs as defined for 64-bit implementations, the use of the segment table hashing function is not required because only 16 segment descriptors are required to define the entire 32-bit (4 Gbyte) address space. These segment descriptors are defined as STEs and are stored in 16 SLB entries designated for that purpose.

7.7.1.3 Segment Table Address Generation

The following sections illustrate the generation of the addresses used for accessing the hashed segment tables. As stated earlier, the operating system must synthesize the segment table search algorithm for setting up the tables.

The base address of the segment table is defined by the higher-order 52 bits of ASR. Bits 52–56 of the STEG address are derived from the hash value. Depending on whether the primary or secondary STEG is to be accessed, the processor uses either the primary or secondary hashing function as described in Section 7.7.1.2, “Segment Table Hashing Functions.” Bits 57–63 of the STEG address are zero. In the process of searching for an STE, the processor first checks STE0 (at the STEG base address). Figure 7-43 provides a graphical description of the generation of the STEG addresses. Note that Figure 7-43 is also an expansion of the virtual address generation shown in Figure 7-17.

In the process of searching for an STE, the processor interprets the values read from memory as described in Section 7.5.2.1.1, “STE Format—64-Bit Implementations.” The entire ESID field of the effective address of the access is compared to the same field of the STEs in memory. In addition, the valid (V) bit is also checked. For a hit to occur, the V bit of the STE in memory must be set. If the ESID field matches and the entry is valid, the STE is considered a hit.

Note that in the case of the segment table, the H bit (defined for PTEs) is not required to distinguish between the primary and secondary STEs. Because the entire ESID field of the access is compared with the entire ESID field of the STE, when there is a hit, the STE should contain the unique mapping of effective to virtual address for the access (provided there are no programming errors).

During a segment table search operation, the processor compares up to 16 STEs: STE0–STE7 of the primary STEG (defined by the primary hashing function) and STE0–STE7 of the secondary STEG (defined by the secondary hashing function). If the ESID field does not match (or if V is not set) for any of these STEs, a segment fault exception condition occurs and an exception is taken. Thus, if no matching (and valid) STE is found for an access, the operating system must load the STE into the segment table.

The architecture does not specify the order in which the STEs are checked. Note that for maximum performance, STEs should be allocated by the operating system first beginning with the STE0 location within the primary STEG, then STE1, and so on. If more than eight STEs are required within the address space that defines a STEG address, the secondary STEG can be used (again, allocation of STE0 of the secondary STEG first, and so on is recommended). Additionally, it may be desirable to place the STEs that will require most frequent access at the beginning of a STEG and reserve the STEs in the secondary STEG for the least frequently accessed STEs.

The architecture also allows for multiple matching STEs to be found within a table search operation. However, multiple matching STEs must be identical in all fields. Otherwise, the translation is undefined.

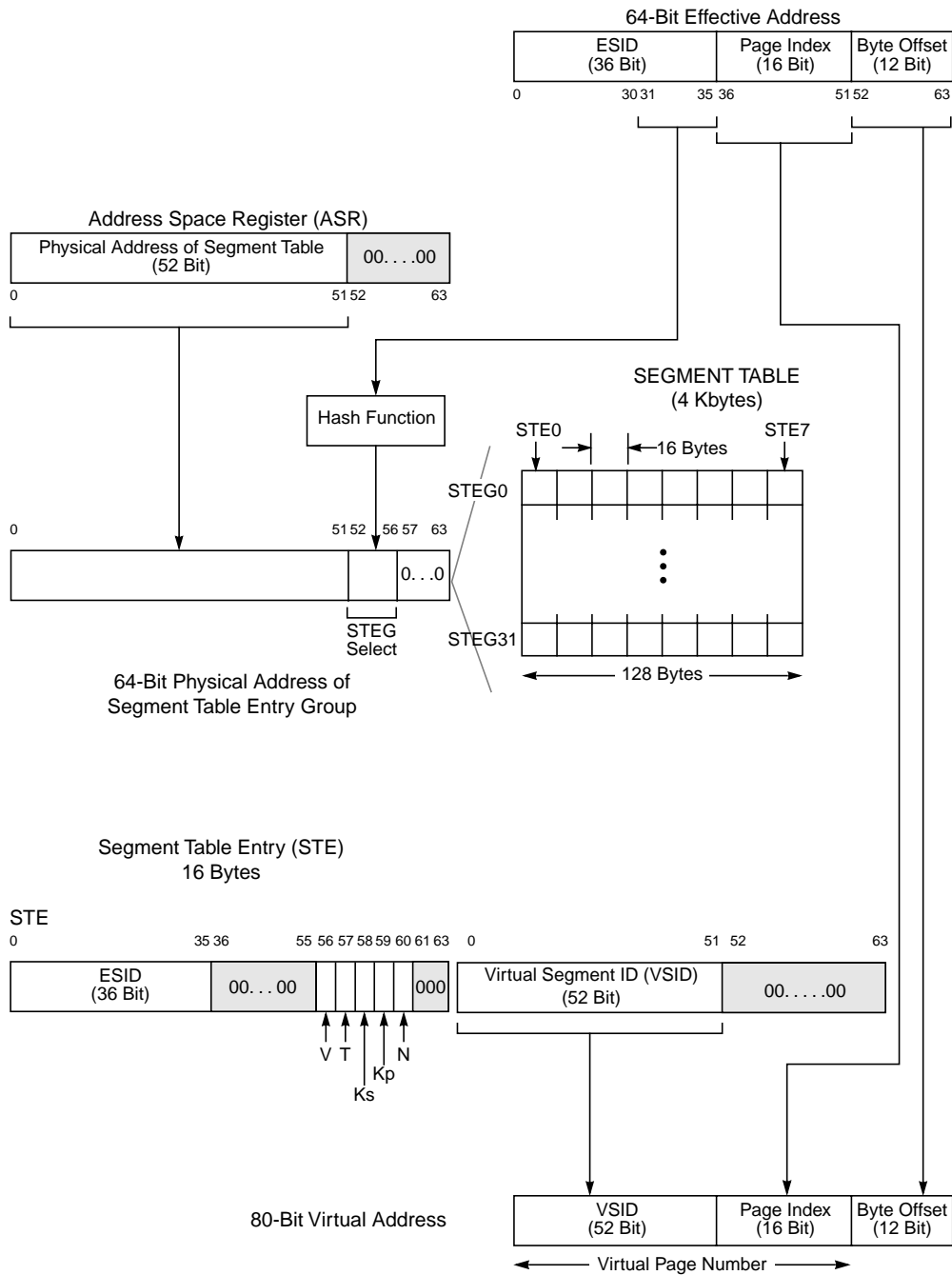

Figure 7-43. Generation of Addresses for Segment Table

7.7.1.4 Segment Table in 32-Bit Mode

As stated earlier, the only effect on the MMU of operating in 32-bit mode ($MSR[SF] = 0$) is that the upper-order 32 bits of the logical (effective) address are truncated (treated as zero). Thus, only the lower-order four bits of the ESID field of the effective address are used in the address translation. These four bits select one of 16 STEGs in the segment table and correspond to the highest-order four bits of an address that would have been generated by a 32-bit implementation. The 16 STEGs can then be used in a way similar to the 16 segment registers defined for 32-bit implementations.

TEMPORARY 64-BIT BRIDGE

Note that operating systems using features of the 64-bit bridge run in 32-bit mode, and just as is the case for 32-bit mode described in the previous paragraph, only 16 segment descriptors are required. When $ASR[V]$ bit is cleared, the $ASR[STABORG]$, which indicates the starting address of the segment table is considered to be invalid. The 16 segment registers are implemented in 16 SLB entries as required by the 64-bit bridge architecture.

7.7.1.5 Segment Table Structure (with Examples)

This section contains an example of an effective address and how its segment descriptor (the STE) maps into the primary STEG in physical memory. The example illustrates how the processor generates STEG addresses for a segment table search operation; this is also the algorithm that must be used by the operating system in creating the segment tables.

In the example shown in Figure 7-44, the value in ASR defines a segment table at address $0x0000_5C80_42A1_7000$ that contains 32 STEGs (all segment tables are defined with a size of 4 Kbytes). The highest-order 36 bits of the effective address are then used to locate the corresponding STE in the segment table. The contents of the STE are then used along with bits 36–63 of the effective address and the 12-bit byte offset to create the 80-bit virtual address.

Example:
Given:

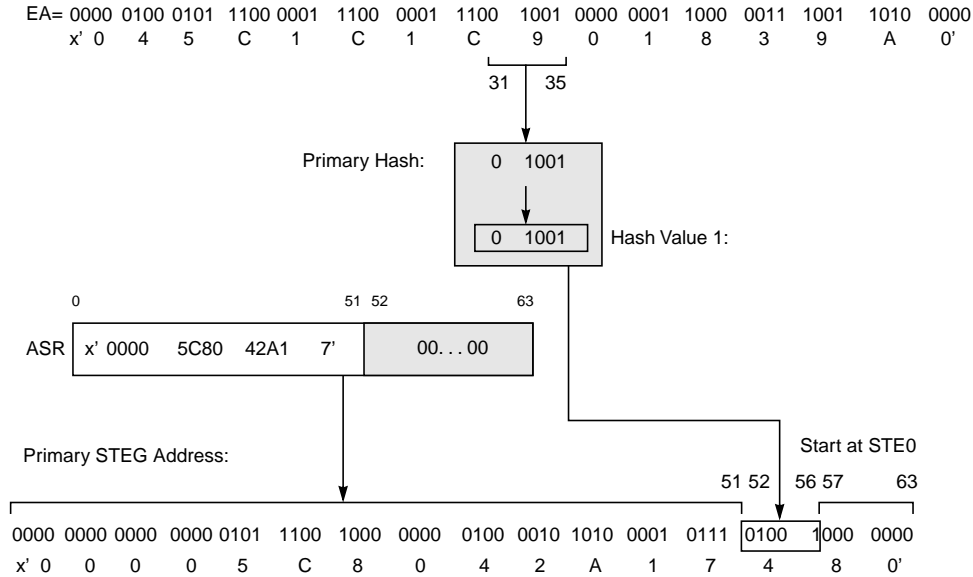

Figure 7-44. Example Primary STEG Address Generation

To locate the primary STEG (in the segment table), EA bits 31–35 are then used as inputs into the primary hashing function (a simple equality function) to generate hash value 1. Hash value 1 is then concatenated with ASR[0–51] and seven lower-order 0 bits, defining the address of the primary STEG (0x0000_5C80_42A1_7480).

Figure 7-45 shows the generation of the secondary STEG address for this example. If the secondary STEG is required, the secondary hash function is performed (one’s complement) and hash value 2 is then concatenated with bits 0–51 of the ASR and seven lower-order 0 bits, defining the address of the secondary STEG (0x0000_5C80_42A1_7B00).

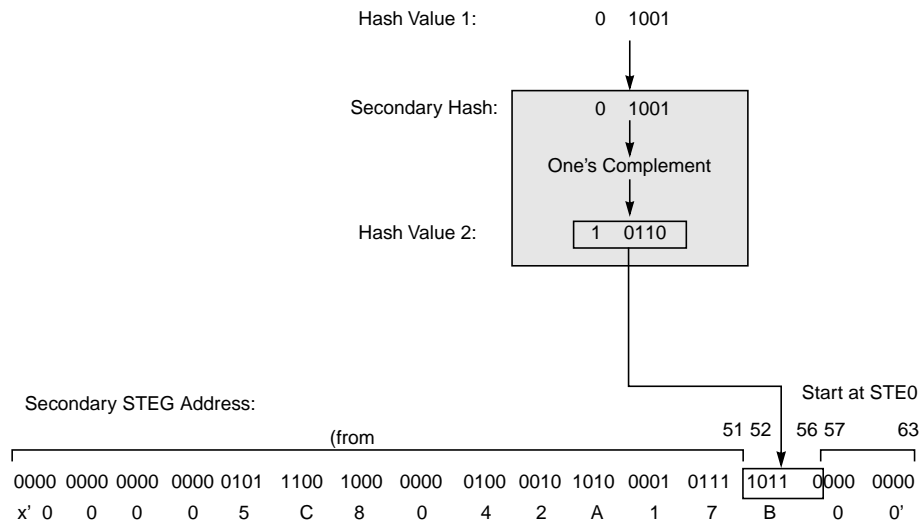

Figure 7-45. Example Secondary STEG Address Generation

As described earlier, because the entire effective segment ID field of the STE is compared with the effective segment ID field of the effective address, when an STE compare process results in a match (hit) with the effective address, the STE mapping should be the unique STE required (provided there are no programming errors).

Note, however, that a given STEG address does not map back to a unique effective address. Not only can a given STEG be considered both a primary and a secondary STEG, but many of the bits of the effective segment ID in the effective address are not used to generate the STEG address. Therefore, any combination of these unused bits will map to the same pair of STEG addresses.

7.7.2 Segment Table Search Operation

The segment table search process performed by a PowerPC processor in the search of an STE is analogous to the page table search algorithm described earlier for PTEs and is as follows:

1. The 64-bit physical addresses of the primary and secondary STEGs are generated as described in Section 7.7.1.3, “Segment Table Address Generation.”
2. As many as 16 STEs (from the primary and secondary STEGs) are read from memory (the architecture does not specify the order of these reads, allowing multiple reads to occur in parallel). STE reads occur with an implied WIM memory/cache mode control bit setting of 0b001. Therefore, they are considered cacheable.
3. The STEs in the selected STEGs are tested for a match with the effective segment ID (ESID) of the access. For a match to occur, the following must be true:
 - STE[V] = 1
 - STE[ESID] = EA[0–35]
4. If no match is found within the eight STEs of the primary STEG and the eight STEs of the secondary STEG, an exception is generated as described in step 7. If a match (or multiple matches) is found, the table search process continues.
5. If multiple matches are found, they must be identical in all defined fields. Otherwise, the translation is undefined.
6. If a match is found, the STE is written into the on-chip SLB (if implemented) and the segment table search is complete.
7. If a match is not found within the primary or secondary PTEG, the search fails, and an exception condition (a page fault) occurs (either an ISI or a DSI exception).

Reads from memory for segment table search operations are performed as if the WIMG bit settings were 0b0010 (that is, as unguarded cacheable operations in which coherency is required).

Figure 7-46 provides a detailed flow diagram of a segment table search operation. Note that the references to SLBs are shown as optional because SLBs are not required; if they do exist, the specifics of how they are maintained are implementation-specific.

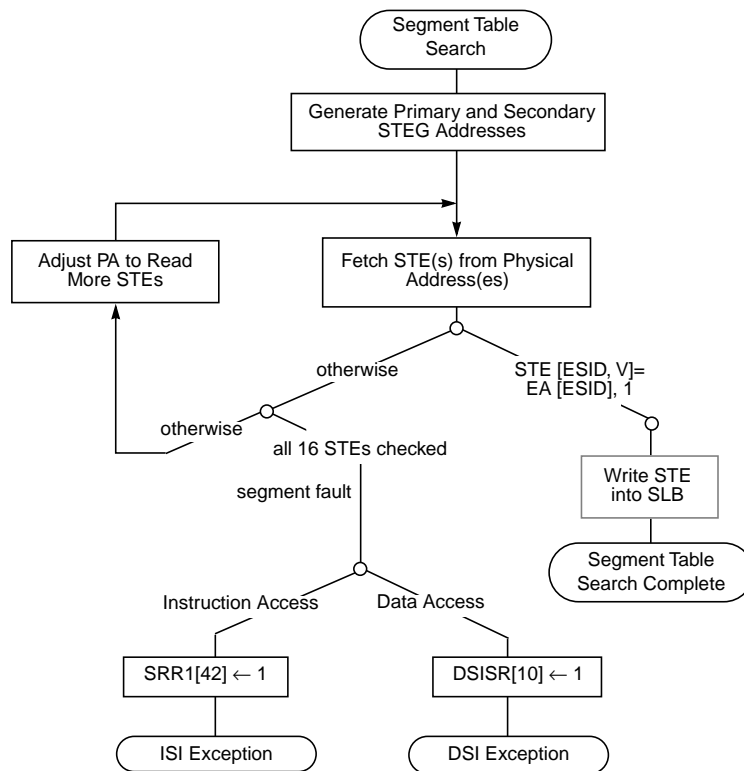

Note: — Implementation-specific

Figure 7-46. Segment Table Search Flow

7.7.3 Segment Table Updates

This section describes the requirements on the software when updating segment tables in memory via some pseudocode examples; note that these requirements are very similar to the requirements imposed on the updating of page tables, but do not have the complication of hardware updates to the referenced and changed bits.

Multiprocessor systems must follow the rules described in this section so that all processors operate with a consistent set of segment tables. Even single processor systems must follow certain rules, because software changes must be synchronized with the other instructions in execution. Updates to the tables include the following operations:

- Adding an STE
- Modifying an STE
- Deleting an STE

STEs must be locked on multiprocessor systems. Access to STEs must be appropriately synchronized by software locking of (that is, guaranteeing exclusive access to) STEs or STEGs if more than one processor can modify the table at that time. In the examples in the following section, `lock()` and `unlock()` refer to software locks that must be performed to provide exclusive access to the STE being updated. However, the architecture does not dictate the specific protocol to be used for locking. See Appendix E, “Synchronization Programming Examples,” for more information about the use of the reservation instructions (such as the **lwarx** and **stwx** instructions) to perform software locking.

On single processor systems, STEs need not be locked. To adapt the examples given below for the single processor case, simply delete the ‘`lock()`’ and ‘`unlock()`’ lines from the examples. The **sync** instructions shown are required even for single processor systems (to ensure that all previous changes to the segment tables have completed).

When SLBs are implemented, they are defined as noncoherent caches of the segment tables. SLB entries must be invalidated explicitly with the SLB invalidate entry instruction (**slbie**) whenever the corresponding STE is modified. The **sync** instruction causes the processor to wait until the SLB invalidate operation in progress by this processor is complete.

TEMPORARY 64-BIT BRIDGE

Note that in the 64-bit bridge, 16 SLB entries are used to hold the 16 segment descriptors necessary for defining the 32-bit address space.

Any processor, including the processor modifying the segment table, may access the segment table at any time in an attempt to reload a SLB entry. An inconsistent segment table entry must never accidentally become visible (if $V = 1$); thus, there must be synchronization between modifications to the valid bit and any other modifications.

As is the case with PTEs, STEs must not be changed in a manner that causes an implicit branch. Section 2.3.18, “Synchronization Requirements for Special Registers and for Lookaside Buffers,” lists the possible implicit branch conditions that can occur when system registers and MSR bits are changed and a complete list of the synchronization requirements for executing the MMU instructions.

The following examples show the required sequence of operations. However, other instructions may be interleaved within the sequences shown.

7.7.3.1 Adding a Segment Table Entry

Adding a segment table entry requires only a lock on the STE in a multiprocessor system. The first bytes in the STE are then written (this example assumes the old valid bit was cleared), the **eieio** instruction orders the update and then the second update can be made. A **sync** instruction ensures that the updates have been made to memory.

```

lock(STE)
if T = 0,
    then
        STE[VSID] ← new value
        eiio /* order 1st STE update before 2nd
        STE[ESID, V, T, Ks, Kp, N] ← new values (Note: N bit only for T = 0 segments)
    else (note that the T = 1 functionality is being phased out of the architecture)
        STE[0b1,CNTRLR_SPEC] ← new values
        eiio /* order 1st STE update before 2nd
        STE[ESID, V, T, Ks, Kp, 0b0] ← new values (V = 1)
sync /* ensure updates completed
unlock(STE)

```

7.7.3.2 Modifying a Segment Table Entry

To change the contents of a currently-valid STE, the STE must be locked, invalidated, updated, invalidated from the SLB, marked valid again, and unlocked. The **sync** instruction must be used at appropriate times to wait for modifications to complete.

```

lock(STE)
STE[V] ← 0 /* other fields don't matter
sync /* ensure update completed
if T = 0,
    then
        STE[VSID] ← new value
        eiio /* order 2nd STE update before 3rd
        STE[ESID, V, T, Ks, Kp, N] ← new values (Note: N bit only for T = 0 segments)
    else (note that the T = 1 functionality is being phased out of the architecture)
        STE[0b1,CNTRLR_SPEC] ← new value
        eiio /* order 2nd STE update before 3rd
        STE[ESID, V, T, Ks, Kp, 0b0] ← new value (V = 1)
slbie(old_EA) /* invalidate old translation
sync /* ensure slbie and last update completed
unlock(STE)

```

7.7.3.3 Deleting a Segment Table Entry

In this example, the entry is locked, marked invalid, invalidated in the SLB, and unlocked.

```

lock(STE)
STE[V] ← 0 /* (other fields don't matter)
sync /* ensure update completed
slbie(old_EA) /* invalidate old translation
sync /* ensure slbie completed
unlock(STE)

```

7.8 Direct-Store Segment Address Translation

As described for memory segments, all accesses generated by the processor (with translation enabled) that do not map to a BAT area, map to a segment descriptor. If $T = 1$ for the selected segment descriptor, the access maps to the direct-store interface, invoking a specific bus protocol for accessing I/O devices.

Direct-store segments are provided for POWER compatibility. As the direct-store interface is present only for compatibility with existing I/O devices that used this interface and the direct-store interface protocol is not optimized for performance, its use is discouraged. Additionally, the direct-store facility is being phased out of the architecture. This functionality is considered optional (to allow for those earlier devices that implemented it). However, future devices are not likely to support it. Thus, software should not depend on its results and new software should not use it. Applications that require low-latency load/store access to external address space should use memory-mapped I/O, rather than the direct-store interface.

7.8.1 Segment Descriptors for Direct-Store Segments

The format of many of the fields in the segment descriptors depends on the value of the T bit. Figure 7-47 shows the format of segment descriptors (residing as STEs in segment tables) that define direct-store segments for 64-bit implementations (T bit is set).

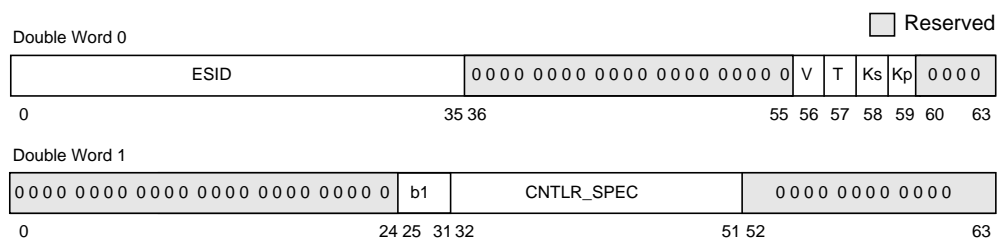

Figure 7-47. Segment Descriptor Format for Direct-Store Segments—64-Bit Implementations

Table 7-28 shows the bit definitions for the segment descriptors when the T bit is set for 64-bit implementations.

Table 7-28. Segment Descriptor Bit Definitions for Direct-Store Segments—64-Bit Implementations

Double Word	Bit	Name	Description
0	0–35	ESID	Effective segment ID
	36–55	—	Reserved
	56	V	Entry valid (V = 1) or invalid (V = 0)
	57	T	T = 1 selects this format
	58	Ks	Supervisor-state protection key
	59	Kp	User-state protection key
	60–63	—	Reserved
1	0–24	—	Reserved
	25–31	b1	Bits 2–8 of the BUID
	32–51	CNTRLR_SPEC	Controller-specific information
	52–63	—	Reserved

In 32-bit implementations, the segment descriptors reside in one of 16 on-chip segment registers. Figure 7-48 shows the register format for the segment registers when the T bit is set for 32-bit implementations.

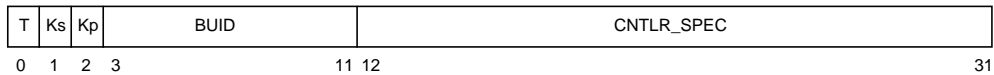

Figure 7-48. Segment Register Format for Direct-Store Segments—32-Bit Implementations

Table 7-29 shows the bit definitions for the segment registers when the T bit is set for 32-bit implementations.

Table 7-29. Segment Register Bit Definitions for Direct-Store Segments

Bit	Name	Description
0	T	T = 1 selects this format.
1	Ks	Supervisor-state protection key
2	Kp	User-state protection key
3–11	BUID	Bus unit ID
12–31	CNTRLR_SPEC	Device-specific data for I/O controller

7.8.2 Direct-Store Segment Accesses

When the address translation process determines that the segment descriptor has $T = 1$, direct-store segment address translation is selected; no reference is made to the page tables and neither the referenced or changed bits are updated. These accesses are performed as if the WIMG bits were 0b0101; that is, caching is inhibited, the accesses bypass the cache, hardware-enforced coherency is not required, and the accesses are considered guarded.

The specific protocol invoked to perform these accesses involves the transfer of address and data information; however, the PowerPC OEA does not define the exact hardware protocol used for direct-store accesses. Some instructions may cause multiple address/data transactions to occur on the bus. In this case, the address for each transaction is handled individually with respect to the MMU.

The following describes the data that is typically sent to the memory controller by processors that implement the direct-store function:

- One of the K_x bits (K_s or K_p) is selected to be the key as follows:
 - For supervisor accesses ($MSR[PR] = 0$), the K_s bit is used and K_p is ignored.
 - For user accesses ($MSR[PR] = 1$), the K_p bit is used and K_s is ignored.
- An implementation-dependent portion of the segment descriptor.
- An implementation-dependent portion of the effective address.

7.8.3 Direct-Store Segment Protection

Page-level memory protection as described in Section 7.5.4, “Page Memory Protection,” is not provided for direct-store segments. The appropriate key bit (K_s or K_p) from the segment descriptor is sent to the memory controller, and the memory controller implements any protection required. Frequently, no such mechanism is provided; the fact that a direct-store segment is mapped into the address space of a process may be regarded as sufficient authority to access the segment.

7.8.4 Instructions Not Supported in Direct-Store Segments

The following instructions are not supported at all and cause either a DSI exception or boundedly-undefined results when issued with an effective address that selects a segment descriptor that has $T = 1$:

- **lwarx** and **ldarx**
- **stwx.** and **stdcx.**
- **eciwx**
- **ecowx**

7.8.5 Instructions with No Effect in Direct-Store Segments

The following instructions are executed as no-ops when issued with an effective address that selects a segment where $T = 1$:

- **dcb**
- **dcbt**
- **dcbtst**
- **dcbf**
- **dcbi**
- **dcbst**
- **dcbz**
- **icbi**

7.8.6 Direct-Store Segment Translation Summary Flow

Figure 7-49 shows the flow used by the MMU when direct-store segment address translation is selected. This figure expands the Direct-Store Segment Translation stub found in Figure 7-5 for both instruction and data accesses. In the case of a floating-point load or store operation to a direct-store segment, it is implementation-specific whether the alignment exception occurs. In the case of an **eciwx**, **ecowx**, **lwarx**, **ldarx**, **stwcx.**, or **stdcx.** instruction, the implementation either sets the DSISR as shown and causes the DSI exception, or causes boundedly-undefined results.

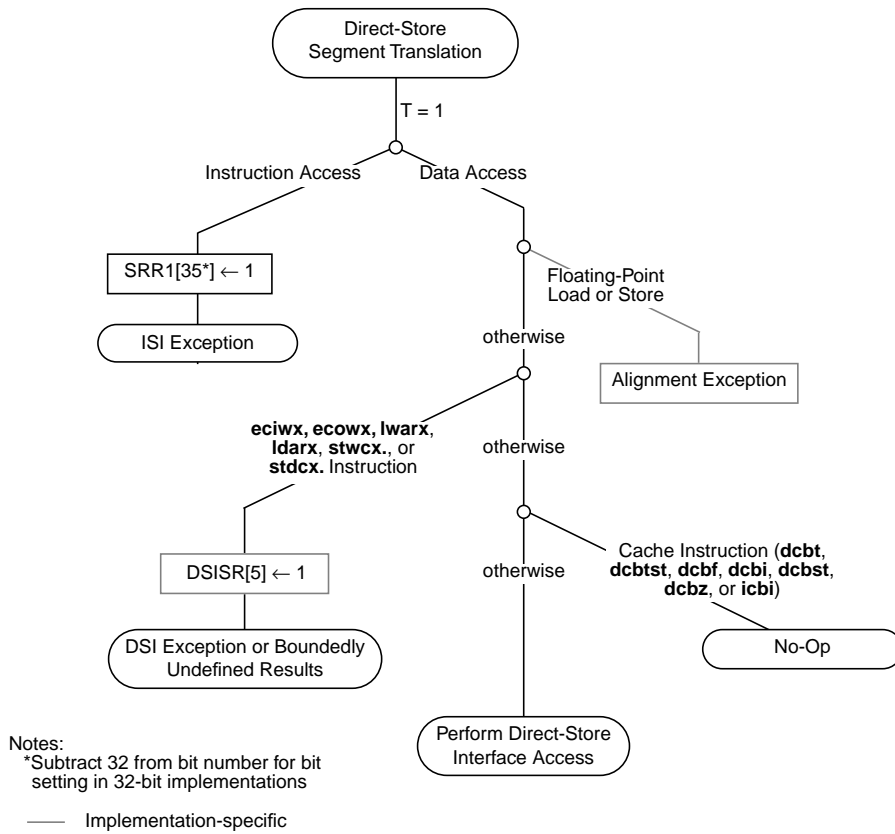

Figure 7-49. Direct-Store Segment Translation Flow

7.9 Migration of Operating Systems from 32-Bit Implementations to 64-Bit Implementations

The facilities and instructions described in this section may optionally be provided by a 64-bit implementation to reduce the amount of software change required to migrate an operating system from a 32-bit implementation to a 64-bit implementation. Using the bridge facility allows the operating system to treat the MSR as a 32-bit register and to continue to use the segment register manipulation instructions (**mtsr**, **mtsrin**, **mfsr**, and **mfsrin**) which are defined for 32-bit implementations. These instructions are otherwise illegal in the 64-bit architecture. Although the 64-bit bridge does not literally implement the 16 registers as they are defined by the 32-bit portion of the architecture, the segment register manipulation instructions are used to access the 16 predefined segment descriptors stored in the on-chip SLBs.

The bridge features do not conceal the differences in format of the page table, BAT registers, and SDR1 between 32-bit and 64-bit implementations—the operating system must be converted explicitly to use the 64-bit formats. Note that an operating system that uses the bridge features does not take full advantage of the 64-bit implementation (for example, it can generate only 32-bit effective addresses).

An operating system that uses the 64-bit bridge architecture should observe the following:

- The boot process should do the following:
 - Clear MSR[SF] and MSR[ISF].
 - Initialize the ASR, clearing ASR[V].
 - Invalidate all SLB entries.
- The operating system should do the following:
 - Support only 32-bit applications.
 - If any 64-bit instructions are used, for example, to modify a PTE or a 64-bit SPR, ensure either that exceptions cannot occur or that the exception handler saves and restores all 64 bits of the GPRs.
 - Manipulate only the low-order 32 bits of the MSR, leaving the high-order 32 bits unchanged.
 - Always have MSR[ISF] = 0 and ASR[V] = 0.
 - Manage virtual segments using the 32-bit segment register manipulation instructions (**mtsr**, **mtsrin**, **mfsr**, and **mfsrin**).
 - Always map segments 0–15 in the SLB when translation is enabled. They may be mapped with a VSID for which there are no valid PTEs.
 - Never execute an **slbie** or **slbia** instruction.
 - Never generate an effective address greater than $2^{32} - 1$ when MSR[SF] = 1.

7.9.1 ISF Bit of the Machine State Register

MSR[ISF] (bit 2) may optionally be used by a 64-bit implementation to control the mode (64-bit or 32-bit) that is entered when an exception is taken. If MSR[ISF] is implemented, it has the properties described below. If it is not implemented, it is treated as reserved except that ISF is assumed to be set for exception handling.

- When an exception occurs, MSR[ISF] is copied to MSR[SF].
- When an exception occurs, MSR[ISF] is not altered.
- No software synchronization is required before or after altering MSR[ISF] (see Section 2.3.18, “Synchronization Requirements for Special Registers and for Lookaside Buffers”).

7.9.2 rfi and mtmsr Instructions in a 64-Bit Implementation

The **rfi** and **mtmsr** instruction pair may be implemented in some 64-bit implementations, along with the **rfid** and **mtmsrd** instructions, which are required by 64-bit implementations. A 64-bit processor must implement either both or neither of these instructions. Attempting to execute either **rfi** or **mtmsr** on a 64-bit processor that does not support these instructions causes an illegal instruction type program exception.

Except for the following variances, the operation of these instructions in a 64-bit implementation is identical to their operation in a 32-bit implementation as described in Section 4.4.1, “System Linkage Instructions—OEA,” and Section 4.4.3.2, “Segment Register Manipulation Instructions.”

- **rfi**
 - The SRR1 bits that are copied to the corresponding bits of the MSR are bits 48–55, 57–59 and 62–63 of SRR1. Note that depending on the implementation, additional bits from SRR1 may be restored to the MSR. The remaining bits of the MSR, including the high-order 32 bits, are unchanged.
 - If the new MSR value does not enable any pending exceptions, the next instruction is fetched, under control of the new MSR value, from the address SRR0[0–61]||0b00 (when SF is set in the new MSR value) or (32)0||SRR0[32–61]||0b00 (when SF is cleared in the new MSR value).
- **mtmsr**
 - Bits 32–63 of rS are placed into MSR[32–63]. MSR[0–31] are unchanged.
Note that an additional 64-bit-specific instruction for reading the MSR is not needed because the **mfmsr** instruction copies the entire contents of the MSR to the selected GPR in both 32- and 64-bit implementations.

7.9.3 Segment Register Manipulation Instructions in the 64-Bit Bridge

The four segment register manipulation instructions, **mtsr**, **mtsrin**, **mfsr**, and **mfsrin**, defined as part of the 32-bit portion of the architecture may optionally be provided by a 64-bit implementation that uses the 64-bit bridge. As part of the 64-bit bridge, these instructions operate as described below rather than in the way they are described for 32-bit implementations (as described in Section 4.4.3.2, “Segment Register Manipulation Instructions.”) These instructions are implemented as a group and are not implemented individually. Attempting to execute one of these instructions on a 64-bit processor on which it is not supported causes an illegal instruction type program exception.

These instructions allow software to associate effective segments 0 through 15 with any of virtual segments 0 through $2^{24} - 1$ without altering the segment table in memory. Sixteen indexed SLB entries serve as virtual segment registers. The **mtsr** and **mtsrin** instructions move 32 bits from a selected GPR to a selected SLB entry. The **mfsr** and **mfsrin** instructions move 64 bits from a selected SLB entry to a selected GPR and can be used to read an SLB entry that was created with **mtsr**, **mtsrin**, **mtsrld**, or **mtsrldin**.

The software synchronization requirements for any of the move to segment register instructions in a 64-bit implementation are the same as for those defined by the 32-bit architecture.

To ensure that SLB entries contain unique ESIDs when the bridge is used, an ESID mapped by any of the move to segment register instructions must not have been mapped to that SLB entry by the segment table when ASR[V] was set.

If an SLB entry that software established using one of the move to segment register instructions is overwritten while ASR[V] = 1, software must be able to handle any exception caused when a segment descriptor cannot be located.

Executing an **mfsr** or **mfsrin** instruction may set rD to an undefined value if ASR[V] has been set at any time since execution of the **mtsr**, **mtsrin**, **mtsrld**, or **mtsrldin** instruction that established the selected SLB entry, because that SLB entry may have been overwritten by the processor in the meantime.

Typically, 16 fixed SLB entries are used by the segment register manipulation instructions, while SLB reload from the segment table selects SLB entries based on some other replacement policy such as LRU.

With respect to updating any SLB replacement history used by the SLB replacement policy, implementations will treat the execution of an **mtsr**, **mtsrld**, **mtsrin**, or **mtsrldin** instruction the same as an SLB reload from the segment table.

The following sections describe the move to and move from segment register instructions as they are defined for the 64-bit bridge.

7.9.4 64-Bit Bridge Implementation of Segment Register Instructions Previously Defined for 32-Bit Implementations Only

The following sections describe the **mfsr**, **mfsrin**, **mtsr**, and **mtsrin** instructions that are defined for the 32-bit architecture and are allowed in the 64-bit bridge architecture only if ASR[V] is implemented. Otherwise, attempting to execute one of these instructions is illegal on a 64-bit implementation.

7.9.4.1 Move from Segment Register—mfsr

As in the 32-bit architecture, the **mfsr** instruction syntax is as follows:

```
mfsr rD,SR
```

The operation of the instruction is described as follows:

$$rD \leftarrow SLB(SR)$$

When executed as part of the 64-bit bridge, the contents of the SLB entry selected by SR are placed into rD; the contents of rD correspond to a segment table entry containing values as shown in Table 7-30.

Table 7-30. Contents of rD after Executing mfsr

Double Word	Bit(s)	Contents	Description
0	0–31	0x0000_0000	ESID[0–31]
	32–35	SR	ESID[32–35]
	36–56	—	—
	57–59	rD[32–34]	T, Ks, Kp
	60–61	rD[35–36]	N, reserved bit, or b0
	62–63	—	—
1	0–24	rD[7–31]	VSID[0–24] (or reserved if SR[T] = 1)
	25–51	rD[37–63]	VSID[25–51] (or b1 and CNTLR_SPEC if SR[T] = 1)
	52–63	—	—

Note: The contents of rD[0–6] are cleared automatically.

If the SLB entry selected by SR was not created by an **mtsr**, **mtsrld**, or **mtsrldin** instruction, the contents of rD are undefined. Formatting for GPR contents is shown in Figure 7-50. Fields shown as x's are ignored. Fields shown as slashes correspond to reserved bits in the segment table entry. Note that the T = 1 (direct-store) facility is being phased out of the architecture and future processors are not likely to support it.

This is a supervisor-level instruction.

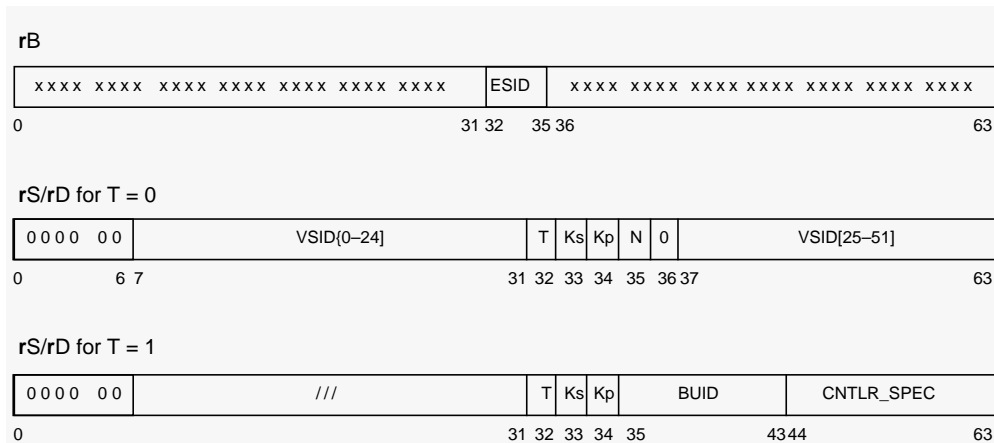

Figure 7-50. GPR Contents for mfsr, mfsrin, mtsrd, and mtsrdin

7.9.4.2 Move from Segment Register Indirect—mfsrin

As in the 32-bit architecture, the **mfsrin** instruction syntax is as follows:

mfsrin rD,rB

The operation of the instruction is described as follows:

$rD \leftarrow SLB(rB[32-35])$

The contents of the SLB entry selected by rB[32-35] are placed into rD; the contents of rD correspond to a segment table entry containing values as shown in Table 7-34:

Table 7-31. SLB Entry Following mfsrin

Double Word	Bit(s)	Contents	Description
0	0-31	0x0000_0000	ESID[0-31]
	32-35	rB[32-35]	ESID[32-35]
	36-56	—	—
	57-59	rD[32-34]	T, Ks, Kp
	60-61	rD[35-36]	N, reserved bit, or b0
1	0-24	rD[7-31]	VSID[0-24] or reserved
	25-51	rD[37-63]	VSID[25-51], or b1, CNTLR_SPEC
	52-63	—	—

Note: The contents of rD[0-6] are cleared automatically.

If the SLB entry selected by `rB[32–35]` was not created by an `mtsr`, `mtsrld`, or `mtsrldin` instruction, the contents of `rD` are undefined. Formatting for GPR contents is shown in Figure 7-50. Fields shown as x's are ignored. Fields shown as slashes correspond to reserved bits in the segment table entry. Note that the `T = 1` (direct-store) facility is being phased out of the architecture and future processors are not likely to support it.

This is a supervisor-level instruction.

7.9.4.3 Move to Segment Register—`mtsr`

As in the 32-bit architecture, the `mtsr` instruction syntax is as follows:

```
mtsr SR,rS
```

The operation of the instruction is described as follows:

$$\text{SLB}(\text{SR}) \leftarrow (\text{rS}[32-63])$$

The SLB entry selected by `SR` is set as though it were loaded from a segment table entry, as shown in Table 7-32.

Table 7-32. SLB Entry Following `mtsr`

Double Word	Bit(s)	Contents	Description
0	0–31	0x0000_0000	ESID[0–31]
	32–35	SR	ESID[32–35]
	36–55	—	—
	56	0b1	V
	57–59	rS[32–34]	T, Ks, Kp
	60–61	rS[35–36]	N, reserved bit, or b0
	62–63	—	—
1	0–24	0x0000_00 0b0	VSID[0–24] or reserved
	25–51	rS[37–63]	VSID[25–51], or b1, CNTLR_SPEC
	51–63	—	—

This is a supervisor-level instruction. Formatting for GPR contents is shown in Figure 7-51. Fields shown as x's are ignored. Fields shown as slashes correspond to reserved bits in the segment table entry. Note that the `T = 1` (direct-store) facility is being phased out of the architecture and future processors are not likely to support it.

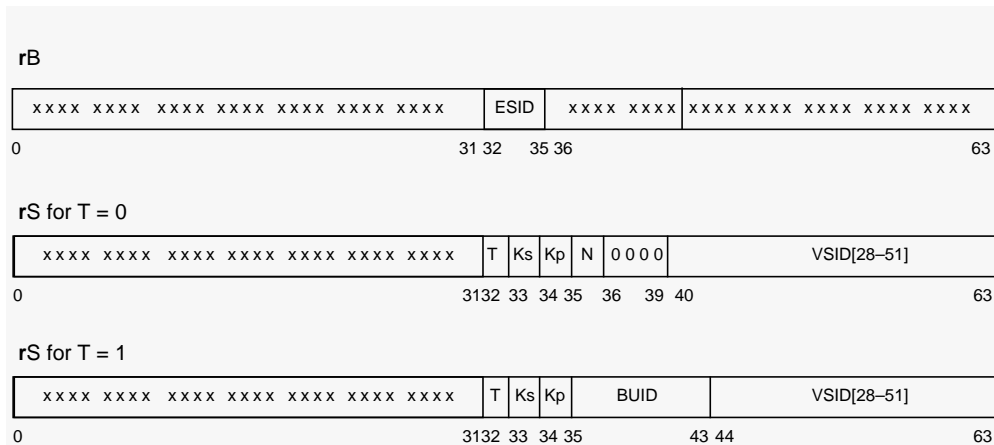

Figure 7-51. GPR Contents for mtsr and mtsrin

Note that when creating a memory segment ($T = 0$) using the **mtsr** instruction, **rS**[36–39] should be cleared, as these bits correspond to the reserved bits in the $T = 0$ format for a segment register.

7.9.4.4 Move to Segment Register Indirect—**mtsrin**

As in the 32-bit architecture, the **mtsrin** instruction syntax is as follows:

mtsrin **rS**,**rB**

The operation of the instruction is described as follows:

$$\text{SLB}(\mathbf{rB}[32-35]) \leftarrow (\mathbf{rS}[32-63])$$

The SLB entry selected by bits 32–35 of **rB** is set as though it were loaded from a segment table entry, as shown in Table 7-34.

Table 7-33. SLB Entry Following mtsrin

Double Word	Bit(s)	Contents	Description
0	0–31	0x0000_0000	ESID[0–31]
	32–35	rB [32–35]	ESID[32–35]
	36–55	—	—
	56	0b1	V
	57–59	rS [32–34]	T, Ks, Kp
	60–61	rS [35–36]	N, reserved bit, or b0
	62–63	—	—

Table 7-33. SLB Entry Following mtsrin (Continued)

Double Word	Bit(s)	Contents	Description
1	0–24	0x0000_00 0b0	VSID[0–24] or reserved
	25–51	rS[37–63]	VSID[25–51], or b1, CNTLR_SPEC
	52–63	—	—

This is a supervisor-level instruction. Formatting for GPR contents is shown in Figure 7-51. Fields shown as x’s are ignored. Fields shown as slashes correspond to reserved bits in the segment table entry.

Note that when creating a memory segment ($T = 0$) using the **mtsrin** instruction, **rS**[36–39] should be cleared, as these bits correspond to the reserved bits in the $T = 0$ format for a segment register. Note also that the $T = 1$ (direct-store) facility is being phased out of the architecture and future processors are not likely to support it.

7.9.5 Segment Register Instructions Defined Exclusively for the 64-Bit Bridge

The following sections describe two instructions **mtsrld** and **mtsrldin**, that are defined for optional use as part of the 64-bit bridge. These instructions support cross-memory operations in a manner similar to that on 32-bit implementations, allowing software to associate effective segments 0–15 (which define the 32-bit address space) with any of virtual segments 0–($2^{52} - 1$) [or virtual segments 0–($2^{36} - 1$) for implementations that support a virtual address size of only 64 bits]. These instructions effectively transfer 64 bits from a selected GPR to a selected SLB entry. This allows an operating system to establish addressability to an address space, to copy data to it from another address space, and then to destroy the new addressability, all without altering the segment table in memory.

Note that altering the segment table is slow because of the software synchronization required, as described in Section 7.7.3, “Segment Table Updates.”

If either instruction is provided, both should be. If neither is provided, attempting to execute either causes an illegal instruction type program exception.

Note that on implementations that support a virtual address size of only 64 bits, bits 0–15 of the VSID field in RS for **mtsrld** and **mtsrldin** must be zeros.

Note that because the existing instructions move the entire contents of the selected SLB entry into the selected GPR, additional versions of the move from segment register instructions are not required.

7.9.5.1 Move to Segment Register Double Word—`mtsrđ`

The `mtsrđ` instruction syntax is as follows:

```
mtsrđ SR,rS
```

The operation of the instruction is described as follows:

```
SLB(SR) ← (rS)
```

The contents of `rS` are placed into the SLB selected by `SR`. The SLB entry is set as though it were loaded from an STE, as shown in Table 7-34.

Table 7-34. SLB Entry Following `mtsrđ`

Double Word	Bit(s)	Contents	Description
0	0–31	0x0000_0000	ESID[0–31]
	32–35	SR	ESID[32–35]
	36–55	—	—
	56	0b1	V
	57–59	rS[32–34]	T, Ks, Kp
	60–61	rS[35–36]	N, reserved bit, or b0
	62–63	—	—
1	0–24	rS[7–31]	VSID[0–24] or reserved
	25–51	rS[37–63]	VSID[25–51], or b1, CNTLR_SPEC
	52–63	—	—

This is a supervisor-level instruction.

This instruction is optional, and defined only for 64-bit implementations. Using it on a 32-bit implementation causes an illegal instruction exception. Formatting for GPR contents is shown in Figure 7-50. Fields shown as zeros should be cleared. Fields shown as hyphens are ignored.

7.9.5.2 Move to Segment Register Double Word Indirect—`mtsrđin`

The syntax for the `mtsrđin` instruction is as follows:

```
mtsrđin rS,rB
```

The operation of the instruction is described as follows:

```
SLB(rB[32–35]) ← (rS)
```

The contents of **rS** are copied to the SLB selected by bits 32–35 of **rB**. The SLB entry is set as though it were loaded from an STE, as shown in Table 7-35.

Table 7-35. SLB Entry Following mtsrdin

Double Word	Bit(s)	Contents	Description
0	0–31	0x0000_0000	ESID[0–31]
	32–35	rB[32–35]	ESID[32–35]
	36–55	—	—
	56	0b1	V
	57–59	rS[32–34]	T, Ks, Kp
	60–61	rS[35–36]	N, reserved bit, or b0
	62–63	—	—
1	0–24	rS[7–31]	VSID[0–24] or reserved
	25–51	rS[37–63]	VSID[25–51], or b1, CNTLR_SPEC
	52–63	—	—

This is a supervisor-level instruction.

This instruction is optional, and defined only for 64-bit implementations. Using it on a 32-bit implementation causes an illegal instruction exception. Fields shown as x's are ignored. Fields shown as slashes correspond to reserved bits in the segment table entry.

Chapter 8

Instruction Set

This chapter lists the PowerPC instruction set in alphabetical order by mnemonic. Note that each entry includes the instruction formats and a quick reference ‘legend’ that provides such information as the level(s) of the PowerPC architecture in which the instruction may be found—user instruction set architecture (UISA), virtual environment architecture (VEA), and operating environment architecture (OEA); and the privilege level of the instruction—user- or supervisor-level (an instruction is assumed to be user-level unless the legend specifies that it is supervisor-level); and the instruction formats. The format diagrams show, horizontally, all valid combinations of instruction fields; for a graphical representation of these instruction formats, see Appendix A, “PowerPC Instruction Set Listings.” The legend also indicates if the instruction is 64-bit, 64-bit bridge, and/or optional. A description of the instruction fields and pseudocode conventions are also provided. For more information on the PowerPC instruction set, refer to Chapter 4, “Addressing Modes and Instruction Set Summary.”

Note that the architecture specification refers to user-level and supervisor-level as problem state and privileged state, respectively.

8.1 Instruction Formats

Instructions are four bytes long and word-aligned, so when instruction addresses are presented to the processor (as in branch instructions) the two low-order bits are ignored. Similarly, whenever the processor develops an instruction address, its two low-order bits are zero.

Bits 0–5 always specify the primary opcode. Many instructions also have an extended opcode. The remaining bits of the instruction contain one or more fields for the different instruction formats.

Some instruction fields are reserved or must contain a predefined value as shown in the individual instruction layouts. If a reserved field does not have all bits cleared, or if a field that must contain a particular value does not contain that value, the instruction form is invalid and the results are as described in Chapter 4, “Addressing Modes and Instruction Set Summary.”

8.1.1 Split-Field Notation

Some instruction fields occupy more than one contiguous sequence of bits or occupy a contiguous sequence of bits used in permuted order. Such a field is called a split field. Split fields that represent the concatenation of the sequences from left to right are shown in lowercase letters. These split fields—mb, me, sh, spr, and tbr—are described in Table 8-1.

Table 8-1. Split-Field Notation and Conventions

Field	Description
mb (21–26)	This field is used in rotate instructions to specify the first 1 bit of a 64-bit mask, as described in Section 4.2.1.4, “Integer Rotate and Shift Instructions.” This field is defined in 64-bit implementations only.
me (21–26)	This field is used in rotate instructions to specify the last 1 bit of a 64-bit mask, as described in Section 4.2.1.4, “Integer Rotate and Shift Instructions.” This field is defined in 64-bit implementations only.
sh (16–20) and sh (30)	These fields are used to specify a shift amount (64-bit implementations only).
spr (11–20)	This field is used to specify a special-purpose register for the mtspr and mfspr instructions. The encoding is described in Section 4.4.2.2, “Move to/from Special-Purpose Register Instructions (OEA).”
tbr (11–20)	This field is used to specify either the time base lower (TBL) or time base upper (TBU).

Split fields that represent the concatenation of the sequences in some order, which need not be left to right (as described for each affected instruction), are shown in uppercase letters. These split fields—MB, ME, and SH—are described in Table 8-2.

8.1.2 Instruction Fields

Table 8-2 describes the instruction fields used in the various instruction formats.

Table 8-2. Instruction Syntax Conventions

Field	Description
AA (30)	Absolute address bit. 0 The immediate field represents an address relative to the current instruction address (CIA). (For more information on the CIA, see Table 8-3.) The effective (logical) address of the branch is either the sum of the LI field sign-extended to 64 bits (32 bits in 32-bit implementations) and the address of the branch instruction or the sum of the BD field sign-extended to 64 bits (32 bits in 32-bit implementations) and the address of the branch instruction. 1 The immediate field represents an absolute address. The effective address (EA) of the branch is the LI field sign-extended to 64 bits (32 bits in 32-bit implementations) or the BD field sign-extended to 64 bits (32 bits in 32-bit implementations). Note: The LI and BD fields are sign-extended to 32 bits in 32-bit implementations.
BD (16–29)	Immediate field specifying a 14-bit signed two’s complement branch displacement that is concatenated on the right with 0b00 and sign-extended to 64 bits (32 bits in 32-bit implementations).
BI (11–15)	This field is used to specify a bit in the CR to be used as the condition of a branch conditional instruction.

Table 8-2. Instruction Syntax Conventions (Continued)

Field	Description
BO (6–10)	This field is used to specify options for the branch conditional instructions. The encoding is described in Section 4.2.4.2, “Conditional Branch Control.”
crbA (11–15)	This field is used to specify a bit in the CR to be used as a source.
crbB (16–20)	This field is used to specify a bit in the CR to be used as a source.
crbD (6–10)	This field is used to specify a bit in the CR, or in the FPSCR, as the destination of the result of an instruction.
crfD (6–8)	This field is used to specify one of the CR fields, or one of the FPSCR fields, as a destination.
crfS (11–13)	This field is used to specify one of the CR fields, or one of the FPSCR fields, as a source.
CRM (12–19)	This field mask is used to identify the CR fields that are to be updated by the mtcrf instruction.
d (16–31)	Immediate field specifying a 16-bit signed two's complement integer that is sign-extended to 64 bits (32 bits in 32-bit implementations).
ds (16–29)	Immediate field specifying a 14-bit signed two's complement integer which is concatenated on the right with 0b00 and sign-extended to 64 bits. This field is defined in 64-bit implementations only.
FM (7–14)	This field mask is used to identify the FPSCR fields that are to be updated by the mtfsf instruction.
frA (11–15)	This field is used to specify an FPR as a source.
frB (16–20)	This field is used to specify an FPR as a source.
frC (21–25)	This field is used to specify an FPR as a source.
frD (6–10)	This field is used to specify an FPR as the destination.
frS (6–10)	This field is used to specify an FPR as a source.
IMM (16–19)	Immediate field used as the data to be placed into a field in the FPSCR.
L (10)	Field used to specify whether an integer compare instruction is to compare 64-bit numbers or 32-bit numbers. This field is defined in 64-bit implementations only.
LI (6–29)	Immediate field specifying a 24-bit signed two's complement integer that is concatenated on the right with 0b00 and sign-extended to 64 bits (32 bits in 32-bit implementations).
LK (31)	Link bit. 0 Does not update the link register (LR). 1 Updates the LR. If the instruction is a branch instruction, the address of the instruction following the branch instruction is placed into the LR.
MB (21–25) and ME (26–30)	These fields are used in rotate instructions to specify a 64-bit mask (32 bits in 32-bit implementations) consisting of 1 bits from bit MB + 32 through bit ME + 32 inclusive, and 0 bits elsewhere, as described in Section 4.2.1.4, “Integer Rotate and Shift Instructions.”
NB (16–20)	This field is used to specify the number of bytes to move in an immediate string load or store.
OE (21)	This field is used for extended arithmetic to enable setting OV and SO in the XER.
OPCD (0–5)	Primary opcode field
rA (11–15)	This field is used to specify a GPR to be used as a source or destination.
rB (16–20)	This field is used to specify a GPR to be used as a source.

Table 8-2. Instruction Syntax Conventions (Continued)

Field	Description
Rc (31)	Record bit. 0 Does not update the condition register (CR). 1 Updates the CR to reflect the result of the operation. For integer instructions, CR bits 0–2 are set to reflect the result as a signed quantity and CR bit 3 receives a copy of the summary overflow bit, XER[SO]. The result as an unsigned quantity or a bit string can be deduced from the EQ bit. For floating-point instructions, CR bits 4–7 are set to reflect floating-point exception, floating-point enabled exception, floating-point invalid operation exception, and floating-point overflow exception. (Note that exceptions are referred to as interrupts in the architecture specification.)
rD (6–10)	This field is used to specify a GPR to be used as a destination.
rS (6–10)	This field is used to specify a GPR to be used as a source.
SH (16–20)	This field is used to specify a shift amount.
SIMM (16–31)	This immediate field is used to specify a 16-bit signed integer.
SR (12–15)	This field is used to specify one of the 16 segment registers (32-bit implementations only).
64-Bit BRIDGE SR (12–15)	This field is used to specify one of the 16 segment registers in 64-bit implementations that provide the optional mtsr , mfsr , and mtsr instructions.
TO (6–10)	This field is used to specify the conditions on which to trap. The encoding is described in Section 4.2.4.6, “Trap Instructions.”
UIMM (16–31)	This immediate field is used to specify a 16-bit unsigned integer.
XO (21–29, 21–30, 22–30, 26–30, 27–29, 27–30, or 30–31)	Extended opcode field. Bits 21–29, 27–29, 27–30, 30–31 pertain to 64-bit implementations only.

8.1.3 Notation and Conventions

The operation of some instructions is described by a semiformal language (pseudocode). See Table 8-3 for a list of pseudocode notation and conventions used throughout this chapter.

Table 8-3. Notation and Conventions

Notation/Convention	Meaning
←	Assignment
← _{iea}	Assignment of an instruction effective address. In 32-bit mode of a 64-bit implementation the high-order 32 bits of the 64-bit target are cleared.
¬	NOT logical operator
*	Multiplication
÷	Division (yielding quotient)
+	Two's-complement addition
–	Two's-complement subtraction, unary minus

Table 8-3. Notation and Conventions (Continued)

Notation/Convention	Meaning
=, ≠	Equals and Not Equals relations
<, ≤, >, ≥	Signed comparison relations
. (period)	Update. When used as a character of an instruction mnemonic, a period (.) means that the instruction updates the condition register field.
c	Carry. When used as a character of an instruction mnemonic, a 'c' indicates a carry out in XER[CA].
e	Extended Precision. When used as the last character of an instruction mnemonic, an 'e' indicates the use of XER[CA] as an operand in the instruction and records a carry out in XER[CA].
o	Overflow. When used as a character of an instruction mnemonic, an 'o' indicates the record of an overflow in XER[OV] and CR0[SO] for integer instructions or CR1[SO] for floating-point instructions.
<U, >U	Unsigned comparison relations
?	Unordered comparison relation
&,	AND, OR logical operators
	Used to describe the concatenation of two values (that is, 010 111 is the same as 010111)
⊕, ≡	Exclusive-OR, Equivalence logical operators (for example, $(a \equiv b) = (a \oplus \neg b)$)
0bnnnn	A number expressed in binary format.
0xnnnn	A number expressed in hexadecimal format.
(n)x	The replication of x, n times (that is, x concatenated to itself n – 1 times). (n)0 and (n)1 are special cases. A description of the special cases follows: <ul style="list-style-type: none"> • (n)0 means a field of n bits with each bit equal to 0. Thus (5)0 is equivalent to 0b00000. • (n)1 means a field of n bits with each bit equal to 1. Thus (5)1 is equivalent to 0b11111.
(rA 0)	The contents of rA if the rA field has the value 1–31, or the value 0 if the rA field is 0.
(rX)	The contents of rX
x[n]	n is a bit or field within x, where x is a register
x ⁿ	x is raised to the nth power
ABS(x)	Absolute value of x
CEIL(x)	Least integer ≥ x
Characterization	Reference to the setting of status bits in a standard way that is explained in the text.
CIA	Current instruction address. The 64- or 32-bit address of the instruction being described by a sequence of pseudocode. Used by relative branches to set the next instruction address (NIA) and by branch instructions with LK = 1 to set the link register. In 32-bit mode of 64-bit implementations, the high-order 32 bits of CIA are always cleared. Does not correspond to any architected register.
Clear	Clear the leftmost or rightmost n bits of a register to 0. This operation is used for rotate and shift instructions.

Table 8-3. Notation and Conventions (Continued)

Notation/Convention	Meaning
Clear left and shift left	Clear the leftmost b bits of a register, then shift the register left by n bits. This operation can be used to scale a known non-negative array index by the width of an element. These operations are used for rotate and shift instructions.
Cleared	Bits are set to 0.
Do	Do loop. <ul style="list-style-type: none"> • Indenting shows range. • "To" and/or "by" clauses specify incrementing an iteration variable. • "While" clauses give termination conditions.
DOUBLE(x)	Result of converting x from floating-point single-precision format to floating-point double-precision format.
Extract	Select a field of n bits starting at bit position b in the source register, right or left justify this field in the target register, and clear all other bits of the target register to zero. This operation is used for rotate and shift instructions.
EXTS(x)	Result of extending x on the left with sign bits
GPR(x)	General-purpose register x
if...then...else...	Conditional execution, indenting shows range, else is optional.
Insert	Select a field of n bits in the source register, insert this field starting at bit position b of the target register, and leave other bits of the target register unchanged. (No simplified mnemonic is provided for insertion of a field when operating on double words; such an insertion requires more than one instruction.) This operation is used for rotate and shift instructions. (Note that simplified mnemonics are referred to as extended mnemonics in the architecture specification.)
Leave	Leave innermost do loop, or the do loop described in leave statement.
MASK(x, y)	Mask having ones in positions x through y (wrapping if $x > y$) and zeros elsewhere.
MEM(x, y)	Contents of y bytes of memory starting at address x . In 32-bit mode of a 64-bit implementation, the high-order 32 bits of the 64-bit value x are ignored.
NIA	Next instruction address, which is the 64- or 32-bit address of the next instruction to be executed (the branch destination) after a successful branch. In pseudocode, a successful branch is indicated by assigning a value to NIA. For instructions which do not branch, the next instruction address is CIA + 4. In 32-bit mode of 64-bit implementations, the high-order 32 bits of NIA are always cleared. Does not correspond to any architected register.
OEA	PowerPC operating environment architecture
Rotate	Rotate the contents of a register right or left n bits without masking. This operation is used for rotate and shift instructions.
ROTL[64](x, y)	Result of rotating the 64-bit value x left y positions
ROTL[32](x, y)	Result of rotating the 64-bit value x x left y positions, where x is 32 bits long
Set	Bits are set to 1.
Shift	Shift the contents of a register right or left n bits, clearing vacated bits (logical shift). This operation is used for rotate and shift instructions.
SINGLE(x)	Result of converting x from floating-point double-precision format to floating-point single-precision format.

Table 8-3. Notation and Conventions (Continued)

Notation/Convention	Meaning
SPR(x)	Special-purpose register x
TRAP	Invoke the system trap handler.
Undefined	An undefined value. The value may vary from one implementation to another, and from one execution to another on the same implementation.
UISA	PowerPC user instruction set architecture
VEA	PowerPC virtual environment architecture

Table 8-4 describes instruction field notation conventions used throughout this chapter.

Table 8-4. Instruction Field Conventions

The Architecture Specification	Equivalent to:
BA, BB, BT	crbA, crbB, crbD (respectively)
BF, BFA	crfD, crfS (respectively)
D	d
DS	ds
FLM	FM
FRA, FRB, FRC, FRT, FRS	frA, frB, frC, frD, frS (respectively)
FXM	CRM
RA, RB, RT, RS	rA, rB, rD, rS (respectively)
SI	SIMM
U	IMM
UI	UIMM
<i>I, II, III</i>	0...0 (shaded)

Precedence rules for pseudocode operators are summarized in Table 8-5.

Table 8-5. Precedence Rules

Operators	Associativity
$x[n]$, function evaluation	Left to right
$(n)x$ or replication, $x(n)$ or exponentiation	Right to left
unary $-$, \neg	Right to left
$*$, $+$	Left to right
$+$, $-$	Left to right
\parallel	Left to right
$=$, \neq , $<$, \leq , $>$, \geq , $<U$, $>U$, $?$	Left to right
$\&$, \oplus , \equiv	Left to right
$ $	Left to right
$-$ (range)	None
\leftarrow , \leftarrow_{iea}	None

Operators higher in Table 8-5 are applied before those lower in the table. Operators at the same level in the table associate from left to right, from right to left, or not at all, as shown. For example, “ $-$ ” (unary minus) associates from left to right, so $a - b - c = (a - b) - c$. Parentheses are used to override the evaluation order implied by Table 8-5, or to increase clarity; parenthesized expressions are evaluated before serving as operands.

8.1.4 Computation Modes

The PowerPC architecture allows for the following types of implementations:

- 64-bit implementations, in which all registers except some special-purpose registers (SPRs) are 64 bits long and effective addresses are 64 bits long. All 64-bit implementations have two modes of operation: 64-bit mode (which is the default) and 32-bit mode. The mode controls how the effective address is interpreted, how condition bits are set, and how the count register (CTR) is tested by branch conditional instructions. All instructions provided for 64-bit implementations are available in both 64- and 32-bit modes.
- 32-bit implementations, in which all registers except the FPRs are 32 bits long and effective addresses are 32 bits long.

Instructions defined in this chapter are provided in both 64-bit implementations and 32-bit implementations unless otherwise stated. Instructions that are provided only for 64-bit implementations are illegal in 32-bit implementations, and vice versa.

Note that all pseudocode examples are given in the default 64-bit mode (unless otherwise stated). To determine 32-bit mode bit field equivalents, simply subtract 32.

For more information on 64-bit and 32-bit modes, refer to Section 1.1.1, “The 64-Bit PowerPC Architecture and the 32-Bit Subset,” and Section 4.1.2, “Computation Modes.”

8.2 PowerPC Instruction Set

The remainder of this chapter lists and describes the instruction set for the PowerPC architecture. The instructions are listed in alphabetical order by mnemonic. Figure 8-1 shows the format for each instruction description page.

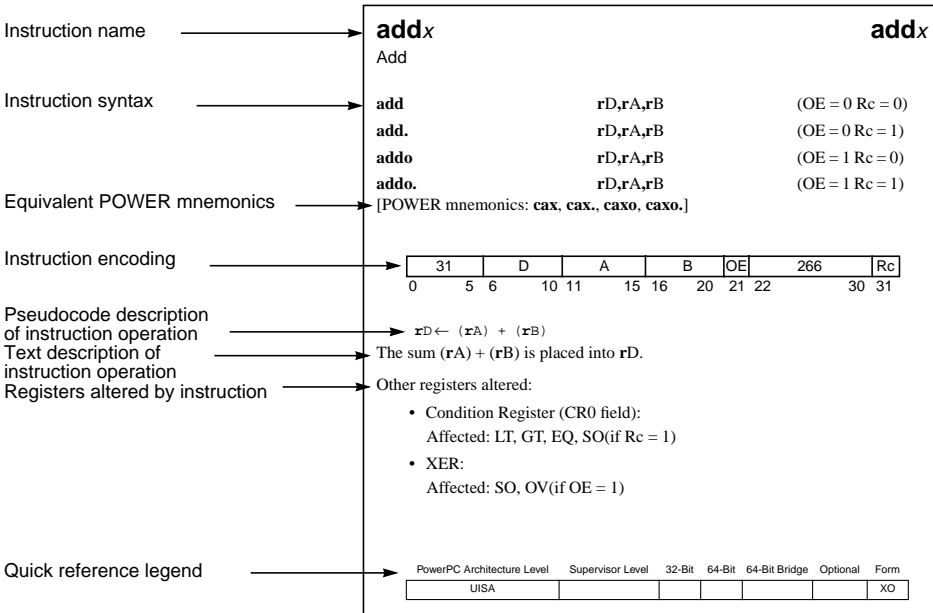

Figure 8-1. Instruction Description

Note that the execution unit that executes the instruction may not be the same for all PowerPC processors.

add_x

Add

add_x

add **rD,rA,rB** (OE = 0 Rc = 0)
add. **rD,rA,rB** (OE = 0 Rc = 1)
addo **rD,rA,rB** (OE = 1 Rc = 0)
addo. **rD,rA,rB** (OE = 1 Rc = 1)

[POWER mnemonics: **cax**, **cax.**, **caxo**, **caxo.**]

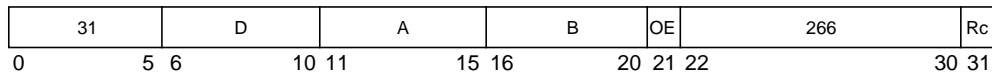

$$rD \leftarrow (rA) + (rB)$$

The sum (rA) + (rB) is placed into rD.

The **add** instruction is preferred for addition because it sets few status bits.

Other registers altered:

- Condition Register (CR0 field):
Affected: LT, GT, EQ, SO (if Rc = 1)
Note: CR0 field may not reflect the infinitely precise result if overflow occurs (see XER below).
- XER:
Affected: SO, OV (if OE = 1)
Note: The setting of the affected bits in the XER is mode-dependent, and reflects overflow of the 64-bit result in 64-bit mode and overflow of the low-order 32-bit result in 32-bit mode. For further information about 64-bit mode and 32-bit mode in 64-bit implementations, see 4.1.2, “Computation Modes.”

PowerPC Architecture Level	Supervisor Level	32-Bit	64-Bit	64-Bit Bridge	Optional	Form
----------------------------	------------------	--------	--------	---------------	----------	------

UISA						XO
------	--	--	--	--	--	----

addc_x

Add Carrying

addc_x

addc **rD,rA,rB** (OE = 0 Rc = 0)
addc. **rD,rA,rB** (OE = 0 Rc = 1)
addco **rD,rA,rB** (OE = 1 Rc = 0)
addco. **rD,rA,rB** (OE = 1 Rc = 1)

[POWER mnemonics: **a**, **a.**, **ao**, **ao.**]

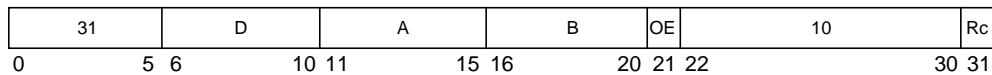

$$rD \leftarrow (rA) + (rB)$$

The sum **(rA) + (rB)** is placed into **rD**.

Other registers altered:

- Condition Register (CR0 field):

Affected: LT, GT, EQ, SO (if Rc = 1)

Note: CR0 field may not reflect the infinitely precise result if overflow occurs (see XER below).

- XER:

Affected: CA

Affected: SO, OV (if OE = 1)

Note: The setting of the affected bits in the XER is mode-dependent, and reflects overflow of the 64-bit result in 64-bit mode and overflow of the low-order 32-bit result in 32-bit mode. For further information about 64-bit mode and 32-bit mode in 64-bit implementations, see 4.1.2, “Computation Modes.”

PowerPC Architecture Level	Supervisor Level	32-Bit	64-Bit	64-Bit Bridge	Optional	Form
UIA						XO

adde_x

Add Extended

adde_x

adde **rD,rA,rB** (OE = 0 Rc = 0)
adde. **rD,rA,rB** (OE = 0 Rc = 1)
addeo **rD,rA,rB** (OE = 1 Rc = 0)
addeo. **rD,rA,rB** (OE = 1 Rc = 1)

[POWER mnemonics: **ae**, **ae.**, **aeo**, **aeo.**]

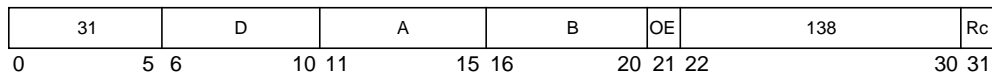

$$rD \leftarrow (rA) + (rB) + XER[CA]$$

The sum $(rA) + (rB) + XER[CA]$ is placed into **rD**.

Other registers altered:

- Condition Register (CR0 field):

Affected: LT, GT, EQ, SO (if Rc = 1)

Note: CR0 field may not reflect the infinitely precise result if overflow occurs (see XER below).

- XER:

Affected: CA

Affected: SO, OV (if OE = 1)

Note: The setting of the affected bits in the XER is mode-dependent, and reflects overflow of the 64-bit result in 64-bit mode and overflow of the low-order 32-bit result in 32-bit mode. For further information about 64-bit mode and 32-bit mode in 64-bit implementations, see 4.1.2, “Computation Modes.”

PowerPC Architecture Level	Supervisor Level	32-Bit	64-Bit	64-Bit Bridge	Optional	Form
UISA						XO

addi

Add Immediate

addi

addi **rD,rA,SIMM**

[POWER mnemonic: **cal**]

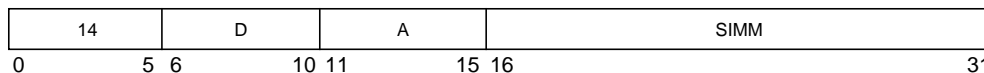

```

if rA = 0 then rD ← EXTS(SIMM)
else      rD ← rA + EXTS(SIMM)

```

The sum (**rA**|0) + **SIMM** is placed into **rD**.

The **addi** instruction is preferred for addition because it sets few status bits. Note that **addi** uses the value 0, not the contents of GPR0, if **rA** = 0.

Other registers altered:

- None

Simplified mnemonics:

li	rD,value	equivalent to	addi rD,0,value
la	rD,disp(rA)	equivalent to	addi rD,rA,disp
subi	rD,rA,value	equivalent to	addi rD,rA,-value

PowerPC Architecture Level	Supervisor Level	32-Bit	64-Bit	64-Bit Bridge	Optional	Form
----------------------------	------------------	--------	--------	---------------	----------	------

UISA						D
------	--	--	--	--	--	---

addic

Add Immediate Carrying

addic

addic **rD,rA,SIMM**

[POWER mnemonic: **ai**]

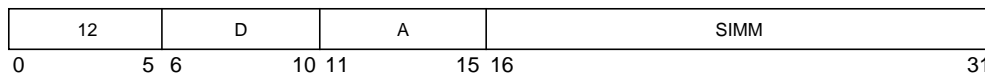

$$rD \leftarrow (rA) + \text{EXTS}(SIMM)$$

The sum $(rA) + SIMM$ is placed into **rD**.

Other registers altered:

- XER:

Affected: CA

Note: The setting of the affected bits in the XER is mode-dependent, and reflects overflow of the 64-bit result in 64-bit mode and overflow of the low-order 32-bit result in 32-bit mode. For further information about 64-bit mode and 32-bit mode in 64-bit implementations, see 4.1.2, “Computation Modes.”

Simplified mnemonics:

subic rD,rA,value equivalent to **addic rD,rA,-value**

PowerPC Architecture Level	Supervisor Level	32-Bit	64-Bit	64-Bit Bridge	Optional	Form
----------------------------	------------------	--------	--------	---------------	----------	------

UISA						D
------	--	--	--	--	--	---

addic.

Add Immediate Carrying and Record

addic. **rD,rA,SIMM**

[POWER mnemonic: **ai.**]

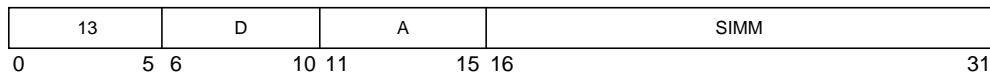

$$rD \leftarrow (rA) + \text{EXTS}(SIMM)$$

The sum $(rA) + SIMM$ is placed into **rD**.

Other registers altered:

- Condition Register (CR0 field):

Affected: LT, GT, EQ, SO

Note: CR0 field may not reflect the infinitely precise result if overflow occurs (see XER below).

- XER:

Affected: CA

Note: The setting of the affected bits in the XER is mode-dependent, and reflects overflow of the 64-bit result in 64-bit mode and overflow of the low-order 32-bit result in 32-bit mode. For further information about 64-bit mode and 32-bit mode in 64-bit implementations, see 4.1.2, “Computation Modes.”

Simplified mnemonics:

subic. rD,rA,value equivalent to **addic. rD,rA,-value**

addic.

PowerPC Architecture Level	Supervisor Level	32-Bit	64-Bit	64-Bit Bridge	Optional	Form
----------------------------	------------------	--------	--------	---------------	----------	------

UISA						D
------	--	--	--	--	--	---

addis

Add Immediate Shifted

addis

addis **rD,rA,SIMM**

[POWER mnemonic: **cau**]

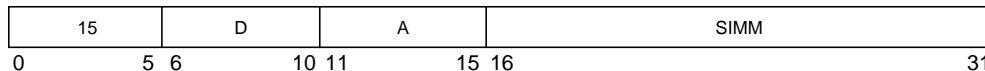

```

if rA = 0 then rD ← EXTS(SIMM || (16)0)
else          rD ← (rA) + EXTS(SIMM || (16)0)

```

The sum **(rA|0) + (SIMM || 0x0000)** is placed into **rD**.

The **addis** instruction is preferred for addition because it sets few status bits. Note that **addis** uses the value 0, not the contents of GPR0, if **rA = 0**.

Other registers altered:

- None

Simplified mnemonics:

lis rD,value	equivalent to	addis rD,0,value
subis rD,rA,value	equivalent to	addis rD,rA,-value

PowerPC Architecture Level	Supervisor Level	32-Bit	64-Bit	64-Bit Bridge	Optional	Form
----------------------------	------------------	--------	--------	---------------	----------	------

UISA						D
------	--	--	--	--	--	---

addme_x

Add to Minus One Extended

addme_x

addme **rD,rA** (OE = 0 Rc = 0)
addme. **rD,rA** (OE = 0 Rc = 1)
addmeo **rD,rA** (OE = 1 Rc = 0)
addmeo. **rD,rA** (OE = 1 Rc = 1)

[POWER mnemonics: **ame**, **ame.**, **ameo**, **ameo.**]

Reserved

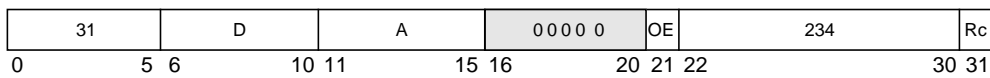

$$rD \leftarrow (rA) + XER[CA] - 1$$

The sum $(rA) + XER[CA] + 0xFFFF_FFFF_FFFF_FFFF$ is placed into **rD**.

Other registers altered:

- Condition Register (CR0 field):

Affected: LT, GT, EQ, SO (if Rc = 1)

Note: CR0 field may not reflect the infinitely precise result if overflow occurs (see XER below).

- XER:

Affected: CA

Affected: SO, OV (if OE = 1)

Note: The setting of the affected bits in the XER is mode-dependent, and reflects overflow of the 64-bit result in 64-bit mode and overflow of the low-order 32-bit result in 32-bit mode. For further information about 64-bit mode and 32-bit mode in 64-bit implementations, see 4.1.2, “Computation Modes.”

PowerPC Architecture Level	Supervisor Level	32-Bit	64-Bit	64-Bit Bridge	Optional	Form
UISA						XO

addze_x

Add to Zero Extended

addze_x

addze **rD,rA** (OE = 0 Rc = 0)
addze. **rD,rA** (OE = 0 Rc = 1)
addzeo **rD,rA** (OE = 1 Rc = 0)
addzeo. **rD,rA** (OE = 1 Rc = 1)

[POWER mnemonics: **aze**, **aze.**, **azeo**, **azeo.**]

Reserved

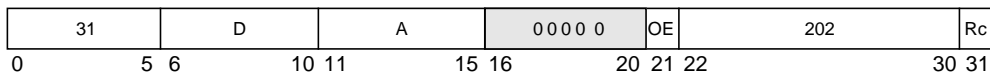

$$rD \leftarrow (rA) + XER[CA]$$

The sum (rA) + XER[CA] is placed into rD.

Other registers altered:

- Condition Register (CR0 field):
 Affected: LT, GT, EQ, SO (if Rc = 1)
Note: CR0 field may not reflect the infinitely precise result if overflow occurs (see XER below).
- XER:
 Affected: CA
 Affected: SO, OV (if OE = 1)
Note: The setting of the affected bits in the XER is mode-dependent, and reflects overflow of the 64-bit result in 64-bit mode and overflow of the low-order 32-bit result in 32-bit mode. For further information about 64-bit mode and 32-bit mode in 64-bit implementations, see 4.1.2, “Computation Modes.”

PowerPC Architecture Level	Supervisor Level	32-Bit	64-Bit	64-Bit Bridge	Optional	Form
UIA						XO

and_x

AND

and_x

and **rA,rS,rB** (Rc = 0)

and. **rA,rS,rB** (Rc = 1)

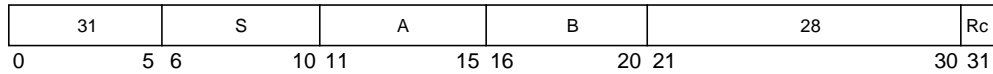

$$rA \leftarrow (rS) \& (rB)$$

The contents of **rS** are ANDed with the contents of **rB** and the result is placed into **rA**.

Other registers altered:

- Condition Register (CR0 field):
 Affected: LT, GT, EQ, SO (if Rc = 1)

PowerPC Architecture Level	Supervisor Level	32-Bit	64-Bit	64-Bit Bridge	Optional	Form
UIA						X

andc_x

AND with Complement

andc_x

andc **rA,rS,rB** (Rc = 0)

andc. **rA,rS,rB** (Rc = 1)

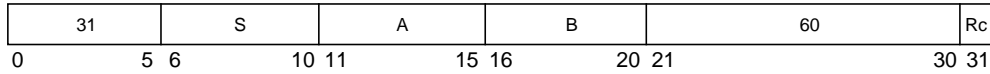

$$rA \leftarrow (rS) + \neg (rB)$$

The contents of **rS** are ANDed with the one's complement of the contents of **rB** and the result is placed into **rA**.

Other registers altered:

- Condition Register (CR0 field):
Affected: LT, GT, EQ, SO (if Rc = 1)

PowerPC Architecture Level	Supervisor Level	32-Bit	64-Bit	64-Bit Bridge	Optional	Form
UISA						X

andi.

AND Immediate

andi.

andi. **rA,rS,UIMM**

[POWER mnemonic: **andil.**]

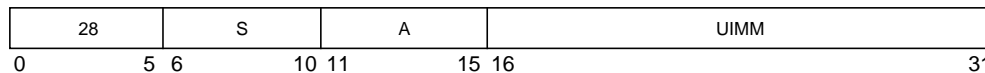

$$rA \leftarrow (rS) \& ((48)0 \parallel UIMM)$$

The contents of **rS** are ANDed with 0x0000_0000_0000 || UIMM and the result is placed into **rA**.

Other registers altered:

- Condition Register (CR0 field):
Affected: LT, GT, EQ, SO

PowerPC Architecture Level	Supervisor Level	32-Bit	64-Bit	64-Bit Bridge	Optional	Form
UISA						D

andis.

AND Immediate Shifted

andis.

andis. **rA,rS,UIMM**

[POWER mnemonic: **andiu.**]

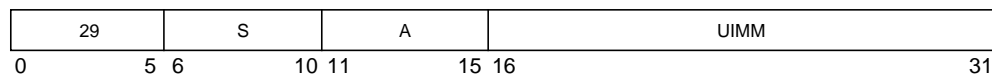

$$rA \leftarrow (rS) + ((32)0 \parallel UIMM \parallel (16)0)$$

The contents of **rS** are ANDed with $0x0000_0000 \parallel UIMM \parallel 0x0000$ and the result is placed into **rA**.

Other registers altered:

- Condition Register (CR0 field):
Affected: LT, GT, EQ, SO

PowerPC Architecture Level Supervisor Level 32-Bit 64-Bit 64-Bit Bridge Optional Form

UISA						D
------	--	--	--	--	--	---

b_x
Branch

b_x

b	target_addr	(AA = 0 LK = 0)
ba	target_addr	(AA = 1 LK = 0)
bl	target_addr	(AA = 0 LK = 1)
bla	target_addr	(AA = 1 LK = 1)

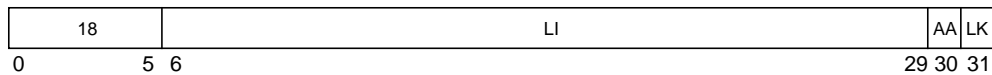

```

if AA then NIA ←iea EXTS(LI || 0b00)
else NIA ←iea CIA + EXTS(LI || 0b00)
if LK then LR ←iea CIA + 4

```

target_addr specifies the branch target address.

If AA = 0, then the branch target address is the sum of LI || 0b00 sign-extended and the address of this instruction, with the high-order 32 bits of the branch target address cleared in 32-bit mode of 64-bit implementations.

If AA = 1, then the branch target address is the value LI || 0b00 sign-extended, with the high-order 32 bits of the branch target address cleared in 32-bit mode of 64-bit implementations.

If LK = 1, then the effective address of the instruction following the branch instruction is placed into the link register.

Other registers altered:

Affected: Link Register (LR) (if LK = 1)

PowerPC Architecture Level	Supervisor Level	32-Bit	64-Bit	64-Bit Bridge	Optional	Form
UISA						I

bc_x

Branch Conditional

bc_x

- bc** BO, BI, target_addr (AA = 0 LK = 0)
- bca** BO, BI, target_addr (AA = 1 LK = 0)
- bcl** BO, BI, target_addr (AA = 0 LK = 1)
- bcla** BO, BI, target_addr (AA = 1 LK = 1)

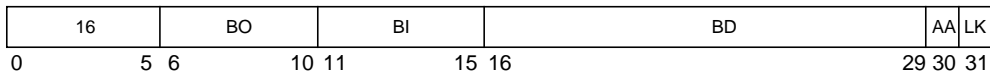

```

if (64-bit implementation) & (64-bit mode)
then m ← 0
else m ← 32
if ¬ BO[2] then CTR ← CTR - 1
ctr_ok ← BO[2] | ((CTR[m-63] ≠ 0) ⊕ BO[3])
cond_ok ← BO[0] | (CR[BI] ≡ BO[1])
if ctr_ok & cond_ok then
  if AA then NIA ←_iea EXTS(BD | | 0b00)
  else NIA ←_iea CIA + EXTS(BD | | 0b00)
  if LK then LR ←_iea CIA + 4

```

The BI field specifies the bit in the condition register (CR) to be used as the condition of the branch. The BO field is encoded as described in Table 8-6. Additional information about BO field encoding is provided in Section 4.2.4.2, “Conditional Branch Control.”

Table 8-6. BO Operand Encodings

BO	Description
0000y	Decrement the CTR, then branch if the decremented CTR[M-63] ≠ 0 and the condition is FALSE.
0001y	Decrement the CTR, then branch if the decremented CTR[M-63] = 0 and the condition is FALSE.
001zy	Branch if the condition is FALSE.
0100y	Decrement the CTR, then branch if the decremented CTR[M-63] ≠ 0 and the condition is TRUE.
0101y	Decrement the CTR, then branch if the decremented CTR[M-63] = 0 and the condition is TRUE.
011zy	Branch if the condition is TRUE.
1z00y	Decrement the CTR, then branch if the decremented CTR[M-63] ≠ 0.
1z01y	Decrement the CTR, then branch if the decremented CTR[M-63] = 0.
1z1zz	Branch always.

M = 32 in 32-bit mode, and M = 0 in the default 64-bit mode. If the BO field specifies that the CTR is to be decremented, the entire 64-bit CTR is decremented regardless of the 32-bit mode or the default 64-bit mode.

In this table, z indicates a bit that is ignored.

Note that the z bits should be cleared, as they may be assigned a meaning in some future version of the PowerPC architecture.

The y bit provides a hint about whether a conditional branch is likely to be taken, and may be used by some PowerPC implementations to improve performance.

target_addr specifies the branch target address.

If AA = 0, the branch target address is the sum of BD || 0b00 sign-extended and the address of this instruction, with the high-order 32 bits of the branch target address cleared in 32-bit mode of 64-bit implementations.

If AA = 1, the branch target address is the value BD || 0b00 sign-extended, with the high-order 32 bits of the branch target address cleared in 32-bit mode of 64-bit implementations.

If LK = 1, the effective address of the instruction following the branch instruction is placed into the link register.

Other registers altered:

Affected: Count Register (CTR) (if BO[2] = 0)

Affected: Link Register (LR) (if LK = 1)

Simplified mnemonics:

blt	target	equivalent to	bc	12,0,target
bne	cr2,target	equivalent to	bc	4,10,target
bdnz	target	equivalent to	bc	16,0,target

PowerPC Architecture Level	Supervisor Level	32-Bit	64-Bit	64-Bit Bridge	Optional	Form
UISA						B

bcctr_x

Branch Conditional to Count Register

bcctr BO,BI (LK = 0)

bcctrl BO,BI (LK = 1)

[POWER mnemonics: **bcc**, **bccl**]

bcctr_x

Reserved

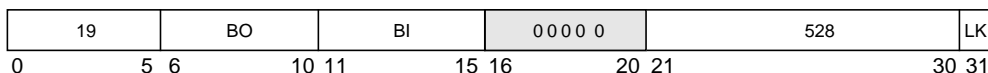

```

cond_ok ← BO[0] | (CR[BI] ≡ BO[1])
if cond_ok then
  NIA ←iea CTR[0-61] || 0b00
  if LK then LR ←iea CIA + 4

```

The BI field specifies the bit in the condition register to be used as the condition of the branch. The BO field is encoded as described in Table 8-7. Additional information about BO field encoding is provided in Section 4.2.4.2, “Conditional Branch Control.”

Table 8-7. BO Operand Encodings

BO	Description
0000y	Decrement the CTR, then branch if the decremented CTR[M-63] ≠ 0 and the condition is FALSE.
0001y	Decrement the CTR, then branch if the decremented CTR[M-63] = 0 and the condition is FALSE.
001zy	Branch if the condition is FALSE.
0100y	Decrement the CTR, then branch if the decremented CTR[M-63] ≠ 0 and the condition is TRUE.
0101y	Decrement the CTR, then branch if the decremented CTR[M-63] = 0 and the condition is TRUE.
011zy	Branch if the condition is TRUE.
1z00y	Decrement the CTR, then branch if the decremented CTR[M-63] ≠ 0.
1z01y	Decrement the CTR, then branch if the decremented CTR[M-63] = 0.
1z1zz	Branch always.

M = 32 in 32-bit mode, and M = 0 in the default 64-bit mode. If the BO field specifies that the CTR is to be decremented, the entire 64-bit CTR is decremented regardless of the 32-bit mode or the default 64-bit mode.

In this table, z indicates a bit that is ignored.

Note that the z bits should be cleared, as they may be assigned a meaning in some future version of the PowerPC architecture.

The y bit provides a hint about whether a conditional branch is likely to be taken, and may be used by some PowerPC implementations to improve performance.

The branch target address is CTR[0-61] || 0b00, with the high-order 32 bits of the branch target address cleared in 32-bit mode of 64-bit implementations.

If LK = 1, the effective address of the instruction following the branch instruction is placed into the link register.

If the “decrement and test CTR” option is specified (BO[2] = 0), the instruction form is invalid.

Other registers altered:

Affected: Link Register (LR) (if LK = 1)

Simplified mnemonics:

blctr	equivalent to	bcctr	12,0
bnctr cr2	equivalent to	bcctr	4,10

PowerPC Architecture Level	Supervisor Level	32-Bit	64-Bit	64-Bit Bridge	Optional	Form
UISA						XL

bclr_x

Branch Conditional to Link Register

bclr_x

bclr BO,BI (LK = 0)

bclr_l BO,BI (LK = 1)

[POWER mnemonics: **bcr**, **bcr_l**]

Reserved

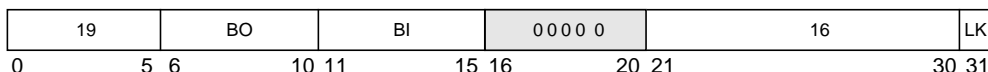

```

if (64-bit implementation) & (64-bit mode)
then m ← 0
else m ← 32
if ¬ BO[2] then CTR ← CTR - 1
ctr_ok ← BO[2] | ((CTR[m-63] ≠ 0) ⊕ BO[3])
cond_ok ← BO[0] | (CR[BI] ≡ BO[1])
if ctr_ok & cond_ok then
  NIA ←iea LR[0-61] || 0b00
  if LK then LR ←iea CIA + 4

```

The BI field specifies the bit in the condition register to be used as the condition of the branch. The BO field is encoded as described in Table 8-8. Additional information about BO field encoding is provided in Section 4.2.4.2, “Conditional Branch Control.”

Table 8-8. BO Operand Encodings

BO	Description
0000y	Decrement the CTR, then branch if the decremented CTR[M-63] ≠ 0 and the condition is FALSE.
0001y	Decrement the CTR, then branch if the decremented CTR[M-63] = 0 and the condition is FALSE.
001zy	Branch if the condition is FALSE.
0100y	Decrement the CTR, then branch if the decremented CTR[M-63] ≠ 0 and the condition is TRUE.
0101y	Decrement the CTR, then branch if the decremented CTR[M-63] = 0 and the condition is TRUE.
011zy	Branch if the condition is TRUE.
1z00y	Decrement the CTR, then branch if the decremented CTR[M-63] ≠ 0.
1z01y	Decrement the CTR, then branch if the decremented CTR[M-63] = 0.
1z1zz	Branch always.

M = 32 in 32-bit mode, and M = 0 in the default 64-bit mode. If the BO field specifies that the CTR is to be decremented, the entire 64-bit CTR is decremented regardless of the 32-bit mode or the default 64-bit mode.

In this table, z indicates a bit that is ignored.

Note that the z bits should be cleared, as they may be assigned a meaning in some future version of the PowerPC architecture.

The y bit provides a hint about whether a conditional branch is likely to be taken, and may be used by some PowerPC implementations to improve performance.

The branch target address is LR[0–61] || 0b00, with the high-order 32 bits of the branch target address cleared in 32-bit mode of 64-bit implementations.

If LK = 1, then the effective address of the instruction following the branch instruction is placed into the link register.

Other registers altered:

Affected: Count Register (CTR) (if BO[2] = 0)

Affected: Link Register (LR) (if LK = 1)

Simplified mnemonics:

bltlr	equivalent to	bclr	12,0
bnelr cr2	equivalent to	bclr	4,10
bdnzlr	equivalent to	bclr	16,0

PowerPC Architecture Level	Supervisor Level	32-Bit	64-Bit	64-Bit Bridge	Optional	Form
UIA						XL

cmpi

Compare Immediate

cmpi

cmpi **crfD,L,rA,SIMM**

Reserved

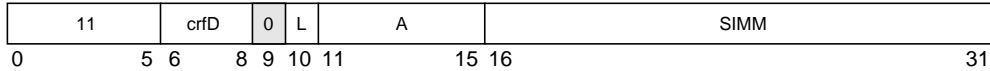

```

if L = 0 then a ← EXTS(rA[32-63])
    else a ← (rA)
if a < EXTS(SIMM) then c ← 0b100
else if a > EXTS(SIMM) then c ← 0b010
else c ← 0b001
CR[4 * crfD - 4 * crfD + 3] ← c || XER[SO]

```

The contents of **rA** (or the low-order 32 bits of **rA** sign-extended to 64 bits if **L = 0**) are compared with the sign-extended value of the **SIMM** field, treating the operands as signed integers. The result of the comparison is placed into **CR** field **crfD**.

In 32-bit implementations, if **L = 1** the instruction form is invalid.

Other registers altered:

- Condition Register (**CR** field specified by operand **crfD**):

Affected: **LT, GT, EQ, SO**

Simplified mnemonics:

cmpdi **rA,value** equivalent to **cmpi 0,1,rA,value**
cmpwi **cr3,rA,value** equivalent to **cmpi 3,0,rA,value**

PowerPC Architecture Level	Supervisor Level	32-Bit	64-Bit	64-Bit Bridge	Optional	Form
----------------------------	------------------	--------	--------	---------------	----------	------

UISA						D
------	--	--	--	--	--	---

cmpl

Compare Logical

cmpl

cmpl **crfD,L,rA,rB**

Reserved

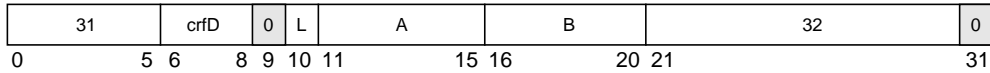

```

if L = 0 then a ← (32)0 || rA[32-63]
             b ← (32)0 || rB[32-63]
             else a ← (rA)
                 b ← (rB)
if a <U b then c ← 0b100
else if a >U b then c ← 0b010
else c ← 0b001
CR[4 * crfD - 4 * crfD + 3] ← c || XER[SO]

```

The contents of **rA** (or the low-order 32 bits of **rA** if **L** = 0) are compared with the contents of **rB** (or the low-order 32 bits of **rB** if **L** = 0), treating the operands as unsigned integers. The result of the comparison is placed into CR field **crfD**.

In 32-bit implementations, if **L** = 1 the instruction form is invalid.

Other registers altered:

- Condition Register (CR field specified by operand **crfD**):
Affected: LT, GT, EQ, SO

Simplified mnemonics:

cmpl rA,rB equivalent to **cmpl 0,1,rA,rB**
cmplw cr3,rA,rB equivalent to **cmpl 3,0,rA,rB**

PowerPC Architecture Level	Supervisor Level	32-Bit	64-Bit	64-Bit Bridge	Optional	Form
----------------------------	------------------	--------	--------	---------------	----------	------

UISA						X
------	--	--	--	--	--	---

cmpli

Compare Logical Immediate

cmpli

cmpli **crfD,L,rA,UIMM**

Reserved

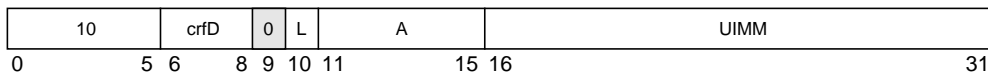

```

if L = 0 then a ← (32)0 || rA[32-63]
    else a ← (rA)
if a <U ((48)0 || UIMM) then c ← 0b100
else if a >U ((48)0 || UIMM) then c ← 0b010
else c ← 0b001
CR[4 * crfD - 4 * crfD + 3] ← c || XER[SO]

```

The contents of **rA** (or the low-order 32 bits of **rA** zero-extended to 64-bits if **L** = 0) are compared with **0x0000_0000_0000 || UIMM**, treating the operands as unsigned integers. The result of the comparison is placed into CR field **crfD**.

In 32-bit implementations, if **L** = 1 the instruction form is invalid.

Other registers altered:

- Condition Register (CR field specified by operand **crfD**):

Affected: LT, GT, EQ, SO

Simplified mnemonics:

cmpldir A,value	equivalent to	cmpli 0,1,rA,value
cmplwi cr3,rA,value	equivalent to	cmpli 3,0,rA,value

PowerPC Architecture Level	Supervisor Level	32-Bit	64-Bit	64-Bit Bridge	Optional	Form
----------------------------	------------------	--------	--------	---------------	----------	------

UISA						D
------	--	--	--	--	--	---

cntlzd_x

64-Bit Implementations Only

cntlzd_x

Count Leading Zeros Double Word

cntlzd **rA,rS** (Rc = 0)
cntlzd. **rA,rS** (Rc = 1)

Reserved

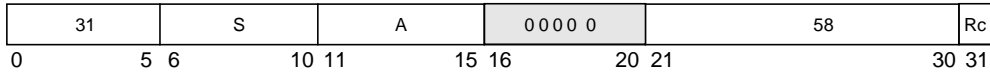

```

n ← 0
do while n < 64
  if rS[n] = 1 then leave
  n ← n + 1
rA ← n

```

A count of the number of consecutive zero bits starting at bit 0 of register **rS** is placed into **rA**. This number ranges from 0 to 64, inclusive.

This instruction is defined only for 64-bit implementations. Using it on a 32-bit implementation will cause the system illegal instruction error handler to be invoked.

Other registers altered:

- Condition Register (CR0 field):
 Affected: LT, GT, EQ, SO (Rc = 1)
Note: If Rc = 1, then LT is cleared in the CR0 field.

PowerPC Architecture Level	Supervisor Level	32-Bit	64-Bit	64-Bit Bridge	Optional	Form
UISA			√			X

cntlzw_X

Count Leading Zeros Word

cntlzw_X

cntlzw **rA,rS** (**Rc = 0**)

cntlzw. **rA,rS** (**Rc = 1**)

[POWER mnemonics: **cntlz**, **cntlz.**]

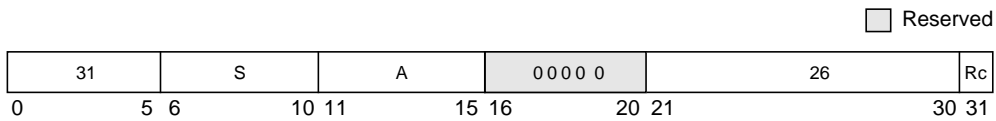

```

n ← 32
do while n < 64
  if rS[n] = 1 then leave
  n ← n + 1
rA ← n - 32

```

A count of the number of consecutive zero bits starting at bit 32 of **rS** (bit 0 in 32-bit implementations) is placed into **rA**. This number ranges from 0 to 32, inclusive.

Other registers altered:

- Condition Register (CR0 field):
 Affected: LT, GT, EQ, SO (if **Rc = 1**)
 Note: If **Rc = 1**, then LT is cleared in the CR0 field.

PowerPC Architecture Level	Supervisor Level	32-Bit	64-Bit	64-Bit Bridge	Optional	Form
UISA						X

crand

Condition Register AND

crand

crand **crbD,crbA,crbB**

Reserved

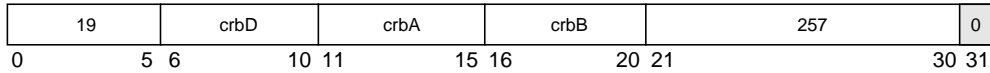

$$CR[crbD] \leftarrow CR[crbA] \& CR[crbB]$$

The bit in the condition register specified by **crbA** is ANDed with the bit in the condition register specified by **crbB**. The result is placed into the condition register bit specified by **crbD**.

Other registers altered:

- Condition Register:
Affected: Bit specified by operand **crbD**

PowerPC Architecture Level	Supervisor Level	32-Bit	64-Bit	64-Bit Bridge	Optional	Form
UIA						XL

crandc

Condition Register AND with Complement

crandc

crandc **crbD,crbA,crbB**

Reserved

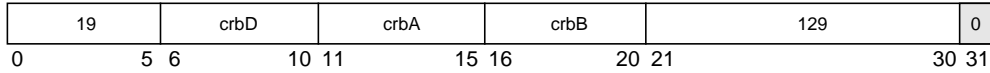

$$CR[crbD] \leftarrow CR[crbA] \& \neg CR[crbB]$$

The bit in the condition register specified by **crbA** is ANDed with the complement of the bit in the condition register specified by **crbB** and the result is placed into the condition register bit specified by **crbD**.

Other registers altered:

- Condition Register:
Affected: Bit specified by operand **crbD**

PowerPC Architecture Level	Supervisor Level	32-Bit	64-Bit	64-Bit Bridge	Optional	Form
----------------------------	------------------	--------	--------	---------------	----------	------

UISA						XL
------	--	--	--	--	--	----

creqv

Condition Register Equivalent

creqv

creqv **crbD,crbA,crbB**

Reserved

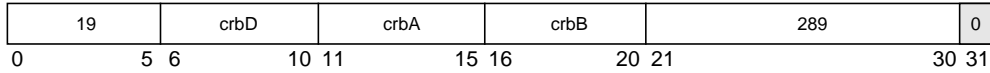

$$CR[crbD] \leftarrow CR[crbA] \oplus CR[crbB]$$

The bit in the condition register specified by **crbA** is XORed with the bit in the condition register specified by **crbB** and the complemented result is placed into the condition register bit specified by **crbD**.

Other registers altered:

- Condition Register:

Affected: Bit specified by operand **crbD**

Simplified mnemonics:

crset crbD equivalent to **creqv crbD,crbD,crbD**

PowerPC Architecture Level	Supervisor Level	32-Bit	64-Bit	64-Bit Bridge	Optional	Form
UISA						XL

crnand

Condition Register NAND

crnand

crnand **crbD,crbA,crbB**

Reserved

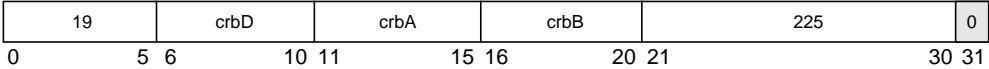

$$CR[crbD] \leftarrow \neg (CR[crbA] \& CR[crbB])$$

The bit in the condition register specified by **crbA** is ANDed with the bit in the condition register specified by **crbB** and the complemented result is placed into the condition register bit specified by **crbD**.

Other registers altered:

- Condition Register:
Affected: Bit specified by operand **crbD**

PowerPC Architecture Level	Supervisor Level	32-Bit	64-Bit	64-Bit Bridge	Optional	Form
UIA						XL

crnor

Condition Register NOR

crnor

crnor **crbD,crbA,crbB**

Reserved

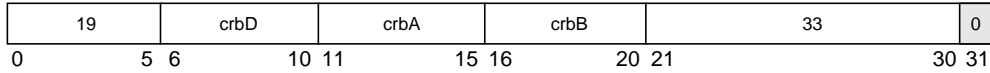

$$CR[crbD] \leftarrow \neg (CR[crbA] \mid CR[crbB])$$

The bit in the condition register specified by **crbA** is ORed with the bit in the condition register specified by **crbB** and the complemented result is placed into the condition register bit specified by **crbD**.

Other registers altered:

- Condition Register:
Affected: Bit specified by operand **crbD**

Simplified mnemonics:

crnot crbD,crbA equivalent to **crnor crbD,crbA,crbA**

PowerPC Architecture Level	Supervisor Level	32-Bit	64-Bit	64-Bit Bridge	Optional	Form
----------------------------	------------------	--------	--------	---------------	----------	------

UISA						XL
------	--	--	--	--	--	----

cror

Condition Register OR

cror

cror **crbD,crbA,crbB**

Reserved

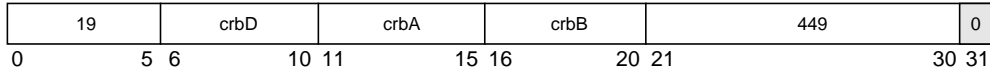

$$CR[crbD] \leftarrow CR[crbA] \mid CR[crbB]$$

The bit in the condition register specified by **crbA** is ORed with the bit in the condition register specified by **crbB**. The result is placed into the condition register bit specified by **crbD**.

Other registers altered:

- Condition Register:

Affected: Bit specified by operand **crbD**

Simplified mnemonics:

crmove crbD,crbA equivalent to **cror crbD,crbA,crbA**

PowerPC Architecture Level	Supervisor Level	32-Bit	64-Bit	64-Bit Bridge	Optional	Form
----------------------------	------------------	--------	--------	---------------	----------	------

UISA						XL
------	--	--	--	--	--	----

crorc

Condition Register OR with Complement

crorc **crbD,crbA,crbB**

crorc

Reserved

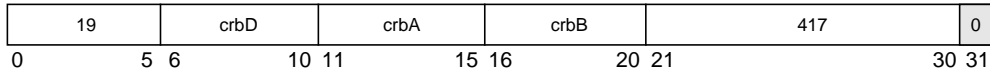

$$CR[crbD] \leftarrow CR[crbA] \mid \neg CR[crbB]$$

The bit in the condition register specified by **crbA** is ORed with the complement of the condition register bit specified by **crbB** and the result is placed into the condition register bit specified by **crbD**.

Other registers altered:

- Condition Register:
Affected: Bit specified by operand **crbD**

PowerPC Architecture Level	Supervisor Level	32-Bit	64-Bit	64-Bit Bridge	Optional	Form
----------------------------	------------------	--------	--------	---------------	----------	------

UISA						XL
------	--	--	--	--	--	----

crxor

Condition Register XOR

crxor

crxor **crbD,crbA,crbB**

Reserved

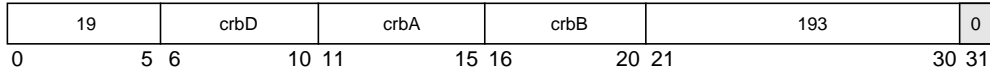

$$CR[crbD] \leftarrow CR[crbA] \oplus CR[crbB]$$

The bit in the condition register specified by **crbA** is XORed with the bit in the condition register specified by **crbB** and the result is placed into the condition register specified by **crbD**.

Other registers altered:

- Condition Register:
Affected: Bit specified by **crbD**

Simplified mnemonics:

crclr crbD equivalent to **crxor crbD,crbD,crbD**

PowerPC Architecture Level	Supervisor Level	32-Bit	64-Bit	64-Bit Bridge	Optional	Form
UIA						XL

Other registers altered:

- None

In the PowerPC OEA, the **dcba** instruction is additionally defined to clear all bytes of a newly established block to zero in the case that the block did not already exist in the cache.

Additionally, as the **dcba** instruction may establish a block in the data cache without verifying that the associated physical address is valid, a delayed machine check exception is possible. See Chapter 6, “Exceptions,” for a discussion about this type of machine check exception.

PowerPC Architecture Level	Supervisor Level	32-Bit	64-Bit	64-Bit Bridge	Optional	Form
VEA					√	X

dcbf

Data Cache Block Flush

dcbf

dcbf **rA,rB**

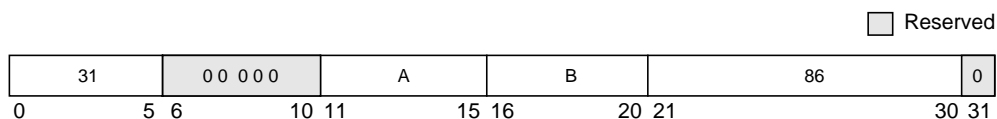

EA is the sum $(rA|0) + (rB)$.

The **dcbf** instruction invalidates the block in the data cache addressed by EA, copying the block to memory first, if there is any dirty data in it. If the processor is a multiprocessor implementation (for example, the 601, 604, 604e and 620) and the block is marked coherency-required, the processor will, if necessary, send an address-only broadcast to other processors. The broadcast of the **dcbf** instruction causes another processor to copy the block to memory, if it has dirty data, and then invalidate the block from the cache.

The action taken depends on the memory mode associated with the block containing the byte addressed by EA and on the state of that block. The list below describes the action taken for the various states of the memory coherency attribute (M bit).

- Coherency required
 - Unmodified block—Invalidates copies of the block in the data caches of all processors.
 - Modified block—Copies the block to memory. Invalidates copies of the block in the data caches of all processors.
 - Absent block—If modified copies of the block are in the data caches of other processors, causes them to be copied to memory and invalidated in those data caches. If unmodified copies are in the data caches of other processors, causes those copies to be invalidated in those data caches.
- Coherency not required
 - Unmodified block—Invalidates the block in the processor's data cache.
 - Modified block—Copies the block to memory. Invalidates the block in the processor's data cache.
 - Absent block (target block not in cache)—No action is taken.

The function of this instruction is independent of the write-through, write-back and caching-inhibited/allowed modes of the block containing the byte addressed by EA.

This instruction is treated as a load from the addressed byte with respect to address translation and memory protection. It is also treated as a load for referenced and changed bit recording except that referenced and changed bit recording may not occur.

Other registers altered:

- None

PowerPC Architecture Level	Supervisor Level	32-Bit	64-Bit	64-Bit Bridge	Optional	Form
VEA						X

dcbst

Data Cache Block Store

dcbst

dcbst **rA,rB**

Reserved

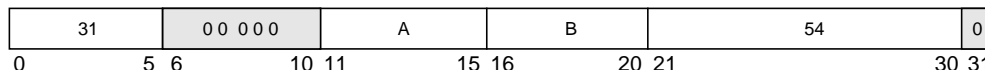

EA is the sum (**rA**[0] + **rB**).

The **dcbst** instruction executes as follows:

- If the block containing the byte addressed by EA is in coherency-required mode, and a block containing the byte addressed by EA is in the data cache of any processor and has been modified, the writing of it to main memory is initiated.
- If the block containing the byte addressed by EA is in coherency-not-required mode, and a block containing the byte addressed by EA is in the data cache of this processor and has been modified, the writing of it to main memory is initiated.

The function of this instruction is independent of the write-through and caching-inhibited/allowed modes of the block containing the byte addressed by EA.

The processor treats this instruction as a load from the addressed byte with respect to address translation and memory protection. It is also treated as a load for referenced and changed bit recording except that referenced and changed bit recording may not occur.

Other registers altered:

- None

PowerPC Architecture Level	Supervisor Level	32-Bit	64-Bit	64-Bit Bridge	Optional	Form
VEA						X

The PowerPC OEA describes how the **dcbz** instruction may establish a block in the data cache without verifying that the associated physical address is valid. This scenario can cause a delayed machine check exception; see Chapter 6, “Exceptions,” for a discussion about this type of machine check exception.

PowerPC Architecture Level	Supervisor Level	32-Bit	64-Bit	64-Bit Bridge	Optional	Form
VEA						X

divd_x

Divide Double Word

64-Bit Implementations Only

divd_x

divd	rD,rA,rB	(OE = 0 R _c = 0)
divd.	rD,rA,rB	(OE = 0 R _c = 1)
divdo	rD,rA,rB	(OE = 1 R _c = 0)
divdo.	rD,rA,rB	(OE = 1 R _c = 1)

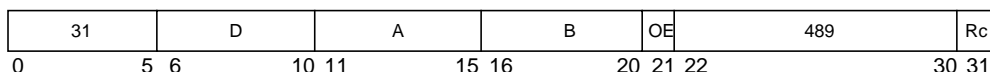

```

dividend[0-63] ← (rA)
divisor[0-63] ← (rB)
rD ← dividend ÷ divisor

```

The 64-bit dividend is the contents of **rA**. The 64-bit divisor is the contents of **rB**. The 64-bit quotient is placed into **rD**. The remainder is not supplied as a result.

Both the operands and the quotient are interpreted as signed integers. The quotient is the unique signed integer that satisfies the equation— $\text{dividend} = (\text{quotient} * \text{divisor}) + r$ —where $0 \leq r < |\text{divisor}|$ if the dividend is non-negative, and $-|\text{divisor}| < r \leq 0$ if the dividend is negative.

If an attempt is made to perform the divisions— $0x8000_0000_0000_0000 \div -1$ or $\langle \text{anything} \rangle \div 0$ —the contents of **rD** are undefined, as are the contents of the LT, GT, and EQ bits of the CR0 field (if $R_c = 1$). In this case, if $OE = 1$ then **OV** is set.

This instruction is defined only for 64-bit implementations. Using it on a 32-bit implementation will cause the system illegal instruction error handler to be invoked.

The 64-bit signed remainder of dividing (**rA**) by (**rB**) can be computed as follows, except in the case that (**rA**) = -2^{63} and (**rB**) = -1 :

divd	rD,rA,rB	# rD = quotient
mulld	rD,rD,rB	# rD = quotient * divisor
subf	rD,rD,rA	# rD = remainder

Other registers altered:

- Condition Register (CR0 field):
Affected: LT, GT, EQ, SO (if Rc = 1)
- XER:
Affected: SO, OV (if OE = 1)

Note: The setting of the affected bits in the XER is mode-independent, and reflects overflow of the 64-bit result.

PowerPC Architecture Level	Supervisor Level	32-Bit	64-Bit	64-Bit Bridge	Optional	Form
UIA			√			XO

divdux

64-Bit Implementations Only

divdux

Divide Double Word Unsigned

divdu	rD,rA,rB	(OE = 0 Rc = 0)
divdu.	rD,rA,rB	(OE = 0 Rc = 1)
divduo	rD,rA,rB	(OE = 1 Rc = 0)
divduo.	rD,rA,rB	(OE = 1 Rc = 1)

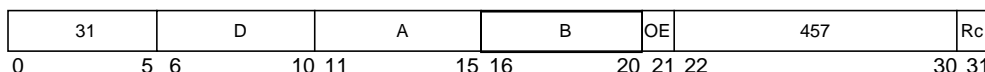

```
dividend[0-63] ← (rA)
divisor[0-63] ← (rB)
rD ← dividend + divisor
```

The 64-bit dividend is the contents of **rA**. The 64-bit divisor is the contents of **rB**. The 64-bit quotient of the dividend and divisor is placed into **rD**. The remainder is not supplied as a result.

Both the operands and the quotient are interpreted as unsigned integers, except that if **Rc** is set to 1 the first three bits of **CR0** field are set by signed comparison of the result to zero. The quotient is the unique unsigned integer that satisfies the equation— $\text{dividend} = (\text{quotient} * \text{divisor}) + r$ —where $0 \leq r < \text{divisor}$.

If an attempt is made to perform the division— $\langle \text{anything} \rangle \div 0$ —the contents of **rD** are undefined as are the contents of the **LT**, **GT**, and **EQ** bits of the **CR0** field (if **Rc** = 1). In this case, if **OE** = 1 then **OV** is set.

This instruction is defined only for 64-bit implementations. Using it on a 32-bit implementation will cause the system illegal instruction error handler to be invoked.

The 64-bit unsigned remainder of dividing (**rA**) by (**rB**) can be computed as follows:

divdu	rD,rA,rB	# rD = quotient
mulld	rD,rD,rB	# rD = quotient * divisor
subf	rD,rD,rA	# rD = remainder

Other registers altered:

- Condition Register (CR0 field):
Affected: LT, GT, EQ, SO (if Rc = 1)
- XER:
Affected: SO, OV (if OE = 1)

Note: The setting of the affected bits in the XER is mode-independent, and reflects overflow of the 64-bit result.

PowerPC Architecture Level	Supervisor Level	32-Bit	64-Bit	64-Bit Bridge	Optional	Form
UIA			√			XO

divw_x

Divide Word

divw_x

divw	rD,rA,rB	(OE = 0 Rc = 0)
divw.	rD,rA,rB	(OE = 0 Rc = 1)
divwo	rD,rA,rB	(OE = 1 Rc = 0)
divwo.	rD,rA,rB	(OE = 1 Rc = 1)

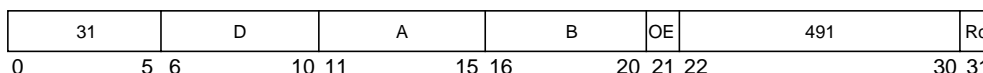

```
dividend[0-63] ← EXTS(rA[32-63])
divisor[0-63] ← EXTS(rB[32-63])
rD[32-63] ← dividend ÷ divisor
rD[0-31] ← undefined
```

The 64-bit dividend is the sign-extended value of the contents of the low-order 32 bits of **rA**. The 64-bit divisor is the sign-extended value of the contents of the low-order 32 bits of **rB**. The 64-bit quotient is formed. The low-order 32 bits of the 64-bit quotient are placed into the low-order 32 bits of **rD**. The contents of the high-order 32 bits of **rD** are undefined. The remainder is not supplied as a result.

Both the operands and the quotient are interpreted as signed integers. The quotient is the unique signed integer that satisfies the equation—dividend = (quotient * divisor) + r where $0 \leq r < |\text{divisor}|$ (if the dividend is non-negative), and $-|\text{divisor}| < r \leq 0$ (if the dividend is negative).

If an attempt is made to perform either of the divisions—`0x8000_0000 ÷ -1` or `<anything> ÷ 0`, then the contents of **rD** are undefined, as are the contents of the LT, GT, and EQ bits of the CR0 field (if Rc = 1). In this case, if OE = 1 then OV is set.

The 32-bit signed remainder of dividing the contents of the low-order 32 bits of **rA** by the contents of the low-order 32 bits of **rB** can be computed as follows, except in the case that the contents of the low-order 32 bits of **rA** = -2^{31} and the contents of the low-order 32 bits of **rB** = -1.

divw	rD,rA,rB	# rD = quotient
mullw	rD,rD,rB	# rD = quotient * divisor
subf	rD,rD,rA	# rD = remainder

Other registers altered:

- Condition Register (CR0 field):

Affected: LT, GT, EQ, SO (if Rc = 1)

LT, GT, EQ undefined (if Rc =1 and 64-bit mode)

- XER:

Affected: SO, OV (if OE = 1)

Note: The setting of the affected bits in the XER is mode-independent, and reflects overflow of the low-order 32-bit result.

PowerPC Architecture Level	Supervisor Level	32-Bit	64-Bit	64-Bit Bridge	Optional	Form
UIA						XO

divwu_x

Divide Word Unsigned

divwu_x

divwu	rD,rA,rB	(OE = 0 Rc = 0)
divwu.	rD,rA,rB	(OE = 0 Rc = 1)
divwuo	rD,rA,rB	(OE = 1 Rc = 0)
divwuo.	rD,rA,rB	(OE = 1 Rc = 1)

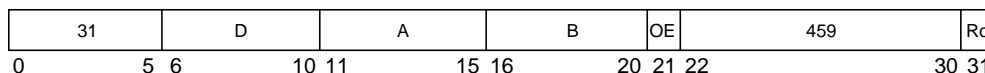

```
dividend[0-63] ← (32)0 || rA[32-63]
divisor[0-63] ← (32)0 || rB[32-63]
rD[32-63] ← dividend ÷ divisor
rD[0-31] ← undefined
```

The 64-bit dividend is the zero-extended value of the contents of the low-order 32 bits of **rA**. The 64-bit divisor is the zero-extended value the contents of the low-order 32 bits of **rB**. A 64-bit quotient is formed. The low-order 32 bits of the 64-bit quotient are placed into the low-order 32 bits of **rD**. The contents of the high-order 32 bits of **rD** are undefined. The remainder is not supplied as a result.

Both operands and the quotient are interpreted as unsigned integers, except that if **Rc** = 1 the first three bits of **CR0** field are set by signed comparison of the result to zero. The quotient is the unique unsigned integer that satisfies the equation— $\text{dividend} = (\text{quotient} * \text{divisor}) + r$ (where $0 \leq r < \text{divisor}$). If an attempt is made to perform the division— $\langle \text{anything} \rangle \div 0$ —then the contents of **rD** are undefined as are the contents of the **LT**, **GT**, and **EQ** bits of the **CR0** field (if **Rc** = 1). In this case, if **OE** = 1 then **OV** is set.

The 32-bit unsigned remainder of dividing the contents of the low-order 32 bits of **rA** by the contents of the low-order 32 bits of **rB** can be computed as follows:

divwu	rD,rA,rB	# rD = quotient
mullw	rD,rD,rB	# rD = quotient * divisor
subf	rD,rD,rA	# rD = remainder

Other registers altered:

- Condition Register (CR0 field):

Affected: LT, GT, EQ, SO (if Rc = 1)

LT, GT, EQ undefined (if Rc =1 and 64-bit mode)

- XER:

Affected: SO, OV (if OE = 1)

Note: The setting of the affected bits in the XER is mode-independent, and reflects overflow of the low-order 32-bit result.

PowerPC Architecture Level	Supervisor Level	32-Bit	64-Bit	64-Bit Bridge	Optional	Form
UIA						XO

eciwx

External Control In Word Indexed

eciwx

eciwx **rD,rA,rB**

Reserved

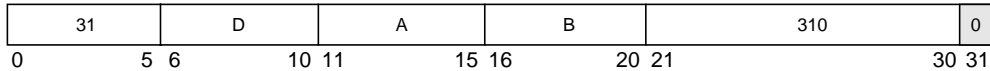

The **eciwx** instruction and the EAR register can be very efficient when mapping special devices such as graphics devices that use addresses as pointers.

```

if rA = 0 then b ← 0
else b ← (rA)
EA ← b + (rB)
paddr ← address translation of EA
send load word request for paddr to device identified by EAR[RID]
rD ← (32)0 || word from device

```

EA is the sum (rA|0) + (rB).

A load word request for the physical address (referred to as real address in the architecture specification) corresponding to EA is sent to the device identified by EAR[RID], bypassing the cache. The word returned by the device is placed in the low-order 32 bits of rD. The contents of the high-order 32 bits of rD are cleared.

EAR[E] must be 1. If it is not, a DSI exception is generated.

EA must be a multiple of four. If it is not, one of the following occurs:

- A system alignment exception is generated.
- A DSI exception is generated (possible only if EAR[E] = 0).
- The results are boundedly undefined.

The **eciwx** instruction is supported for EAs that reference memory segments in which SR[T] = 1 (or STE[T] = 1) and for EAs mapped by the DBAT registers. If the EA references a direct-store segment (SR[T] = 1 or STE[T] = 1), either a DSI exception occurs or the results are boundedly undefined. However, note that the direct-store facility is being phased out of the architecture and will not likely be supported in future devices. Thus, software should not depend on its effects.

If this instruction is executed when MSR[DR] = 0 (real addressing mode), the results are boundedly undefined.

This instruction is treated as a load from the addressed byte with respect to address translation, memory protection, referenced and changed bit recording, and the ordering performed by **eieio**.

This instruction is optional in the PowerPC architecture.

Other registers altered:

- None

PowerPC Architecture Level	Supervisor Level	32-Bit	64-Bit	64-Bit Bridge	Optional	Form
VEA					√	X

ecowx

External Control Out Word Indexed

ecowx

ecowx rS,rA,rB

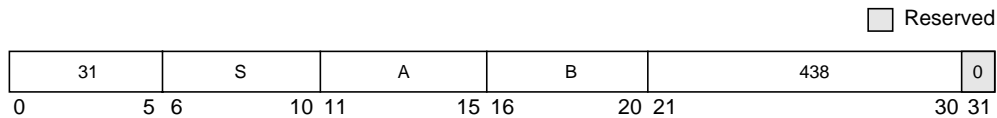

The **ecowx** instruction and the EAR register can be very efficient when mapping special devices such as graphics devices that use addresses as pointers.

```
if rA = 0 then b ← 0
else b ← (rA)
EA ← b + (rB)
paddr ← address translation of EA
send store word request for paddr to device identified by EAR[RID]
send rS[32-63] to device
```

EA is the sum (rA[0] + (rB).

A store word request for the physical address corresponding to EA and the contents of the low-order 32 bits of rS are sent to the device identified by EAR[RID], bypassing the cache.

EAR[E] must be 1, if it is not, a DSI exception is generated. EA must be a multiple of four. If it is not, one of the following occurs:

- A system alignment exception is generated.
- A DSI exception is generated (possible only if EAR[E] = 0).
- The results are boundedly undefined.

The **ecowx** instruction is supported for effective addresses that reference memory segments in which SR[T] = 0 (or STE[T] = 0), and for EAs mapped by the DBAT registers. If the EA references a direct-store segment (SR[T] = 1 or STE[T] = 1), either a DSI exception occurs or the results are boundedly undefined. However, note that the direct-store facility is being phased out of the architecture and will not likely be supported in future devices. Thus, software should not depend on its effects.

If this instruction is executed when MSR[DR] = 0 (real addressing mode), the results are boundedly undefined.

This instruction is treated as a store from the addressed byte with respect to address translation, memory protection, and referenced and changed bit recording, and the ordering performed by **eiio**. Note that software synchronization is required in order to ensure that the data access is performed in program order with respect to data accesses caused by other store or **ecowx** instructions, even though the addressed byte is assumed to be caching-inhibited and guarded.

This instruction is optional in the PowerPC architecture.

Other registers altered:

- None

PowerPC Architecture Level	Supervisor Level	32-Bit	64-Bit	64-Bit Bridge	Optional	Form
VEA					√	X

eieio

Enforce In-Order Execution of I/O

eieio

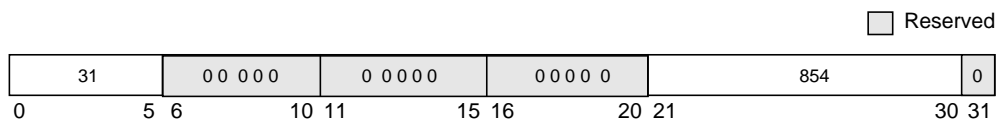

The **eieio** instruction provides an ordering function for the effects of load and store instructions executed by a processor. These loads and stores are divided into two sets, which are ordered separately. The memory accesses caused by a **dcbz** or a **dcbz** instruction are ordered like a store. The two sets follow:

1. Loads and stores to memory that is both caching-inhibited and guarded, and stores to memory that is write-through required.

The **eieio** instruction controls the order in which the accesses are performed in main memory. It ensures that all applicable memory accesses caused by instructions preceding the **eieio** instruction have completed with respect to main memory before any applicable memory accesses caused by instructions following the **eieio** instruction access main memory. It acts like a barrier that flows through the memory queues and to main memory, preventing the reordering of memory accesses across the barrier. No ordering is performed for **dcbz** if the instruction causes the system alignment error handler to be invoked.

All accesses in this set are ordered as a single set—that is, there is not one order for loads and stores to caching-inhibited and guarded memory and another order for stores to write-through required memory.

2. Stores to memory that have all of the following attributes—caching-allowed, write-through not required, and memory-coherency required.

The **eieio** instruction controls the order in which the accesses are performed with respect to coherent memory. It ensures that all applicable stores caused by instructions preceding the **eieio** instruction have completed with respect to coherent memory before any applicable stores caused by instructions following the **eieio** instruction complete with respect to coherent memory.

With the exception of **dcbz** and **dcbz**, **eieio** does not affect the order of cache operations (whether caused explicitly by execution of a cache management instruction, or implicitly by the cache coherency mechanism). For more information, refer to Chapter 5, “Cache Model and Memory Coherency.” The **eieio** instruction does not affect the order of accesses in one set with respect to accesses in the other set.

The **eieio** instruction may complete before memory accesses caused by instructions preceding the **eieio** instruction have been performed with respect to main memory or coherent memory as appropriate.

The **eiio** instruction is intended for use in managing shared data structures, in accessing memory-mapped I/O, and in preventing load/store combining operations in main memory. For the first use, the shared data structure and the lock that protects it must be altered only by stores that are in the same set (1 or 2; see previous discussion). For the second use, **eiio** can be thought of as placing a barrier into the stream of memory accesses issued by a processor, such that any given memory access appears to be on the same side of the barrier to both the processor and the I/O device.

Because the processor performs store operations in order to memory that is designated as both caching-inhibited and guarded (refer to Section 5.1.1, “Memory Access Ordering”), the **eiio** instruction is needed for such memory only when loads must be ordered with respect to stores or with respect to other loads.

Note that the **eiio** instruction does not connect hardware considerations to it such as multiprocessor implementations that send an **eiio** address-only broadcast (useful in some designs). For example, if a design has an external buffer that re-orders loads and stores for better bus efficiency, the **eiio** broadcast signals to that buffer that previous loads/stores (marked caching-inhibited, guarded, or write-through required) must complete before any following loads/stores (marked caching-inhibited, guarded, or write-through required).

Other registers altered:

- None

PowerPC Architecture Level	Supervisor Level	32-Bit	64-Bit	64-Bit Bridge	Optional	Form
VEA						X

eqv_x
Equivalent

eqv_x

eqv **rA,rS,rB** (**Rc = 0**)
eqv. **rA,rS,rB** (**Rc = 1**)

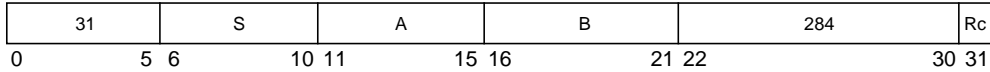

$$rA \leftarrow (rS) \equiv (rB)$$

The contents of **rS** are XORed with the contents of **rB** and the complemented result is placed into **rA**.

Other registers altered:

- Condition Register (CR0 field):
 Affected: LT, GT, EQ, SO (if Rc = 1)

PowerPC Architecture Level	Supervisor Level	32-Bit	64-Bit	64-Bit Bridge	Optional	Form
UISA						X

extsb_X

Extend Sign Byte

extsb **rA,rS** (Rc = 0)
extsb. **rA,rS** (Rc = 1)

extsb_X

Reserved

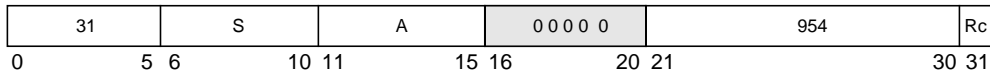

$S \leftarrow rS[56]$
 $rA[56-63] \leftarrow rS[56-63]$
 $rA[0-55] \leftarrow (56)S$

The contents of the low-order eight bits of **rS** are placed into the low-order eight bits of **rA**. Bit 56 of **rS** is placed into the remaining bits of **rA**.

Other registers altered:

- Condition Register (CR0 field):
Affected: LT, GT, EQ, SO (if Rc = 1)

PowerPC Architecture Level	Supervisor Level	32-Bit	64-Bit	64-Bit Bridge	Optional	Form
UIA						X

extsw_X
Extend Sign Word

64-Bit Implementations Only

extsw_X

extsw **rA,rS** (Rc = 0)
extsw. **rA,rS** (Rc = 1)

Reserved

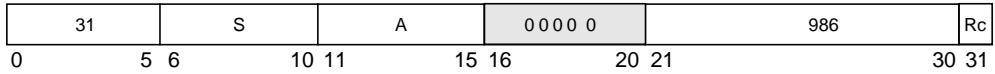

$S \leftarrow rS[32]$
 $rA[32-63] \leftarrow rS[32-63]$
 $rA[0-31] \leftarrow (32)S$

The contents of the low-order 32 bits of **rS** are placed into the low-order 32 bits of **rA**. Bit 32 of **rS** is placed into the high-order 32 bits of **rA**.

This instruction is defined only for 64-bit implementations. Using it on a 32-bit implementation will cause the system illegal instruction error handler to be invoked.

Other registers altered:

- Condition Register (CR0 field):
 Affected: LT, GT, EQ, SO (if Rc = 1)

PowerPC Architecture Level	Supervisor Level	32-Bit	64-Bit	64-Bit Bridge	Optional	Form
UISA			√			X

fabs_x

Floating Absolute Value

fabs_x

fabs **frD,frB** (Rc = 0)

fabs. **frD,frB** (Rc = 1)

Reserved



The contents of **frB** with bit 0 cleared are placed into **frD**.

Note that the **fabs** instruction treats NaNs just like any other kind of value. That is, the sign bit of a NaN may be altered by **fabs**. This instruction does not alter the FPSCR.

Other registers altered:

- Condition Register (CR1 field):
Affected: FX, FEX, VX, OX (if Rc = 1)

PowerPC Architecture Level	Supervisor Level	32-Bit	64-Bit	64-Bit Bridge	Optional	Form
UISA						X

fadd_x

Floating Add (Double-Precision)

fadd **frD,frA,frB** (Rc = 0)

fadd. **frD,frA,frB** (Rc = 1)

[POWER mnemonics: **fa**, **fa.**]

fadd_x

Reserved

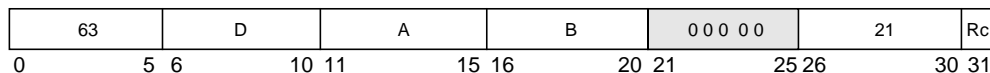

The floating-point operand in **frA** is added to the floating-point operand in **frB**. If the most-significant bit of the resultant significand is not a one, the result is normalized. The result is rounded to double-precision under control of the floating-point rounding control field RN of the FPSCR and placed into **frD**.

Floating-point addition is based on exponent comparison and addition of the two significands. The exponents of the two operands are compared, and the significand accompanying the smaller exponent is shifted right, with its exponent increased by one for each bit shifted, until the two exponents are equal. The two significands are then added or subtracted as appropriate, depending on the signs of the operands. All 53 bits in the significand as well as all three guard bits (G, R, and X) enter into the computation.

If a carry occurs, the sum's significand is shifted right one bit position and the exponent is increased by one. FPSCR[FPRF] is set to the class and sign of the result, except for invalid operation exceptions when FPSCR[VE] = 1.

Other registers altered:

- Condition Register (CR1 field):
Affected: FX, FEX, VX, OX (if Rc = 1)
- Floating-Point Status and Control Register:
Affected: FPRF, FR, FI, FX, OX, UX, XX, VXSNaN, VXISI

PowerPC Architecture Level	Supervisor Level	32-Bit	64-Bit	64-Bit Bridge	Optional	Form
UISA						A

fadds_x

Floating Add Single

fadds **frD,frA,frB** (Rc = 0)

fadds. **frD,frA,frB** (Rc = 1)

fadds_x

Reserved

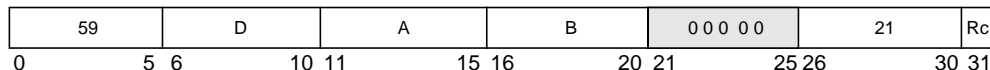

The floating-point operand in **frA** is added to the floating-point operand in **frB**. If the most-significant bit of the resultant significand is not a one, the result is normalized. The result is rounded to the single-precision under control of the floating-point rounding control field RN of the FPSCR and placed into **frD**.

Floating-point addition is based on exponent comparison and addition of the two significands. The exponents of the two operands are compared, and the significand accompanying the smaller exponent is shifted right, with its exponent increased by one for each bit shifted, until the two exponents are equal. The two significands are then added or subtracted as appropriate, depending on the signs of the operands. All 53 bits in the significand as well as all three guard bits (G, R, and X) enter into the computation.

If a carry occurs, the sum's significand is shifted right one bit position and the exponent is increased by one. FPSCR[FPRF] is set to the class and sign of the result, except for invalid operation exceptions when FPSCR[VE] = 1.

Other registers altered:

- Condition Register (CR1 field):
Affected: FX, FEX, VX, OX (if Rc = 1)
- Floating-Point Status and Control Register:
Affected: FPRF, FR, FI, FX, OX, UX, XX, VXSNaN, VXISI

PowerPC Architecture Level Supervisor Level 32-Bit 64-Bit 64-Bit Bridge Optional Form

UISA						A
------	--	--	--	--	--	---

fcfid_x

64-Bit Implementations Only

fcfid_x

Floating Convert from Integer Double Word

fcfid **frD,frB** (Rc = 0)

fcfid. **frD,frB** (Rc = 1)

Reserved

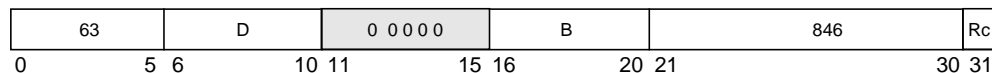

The 64-bit signed fixed-point operand in register **frB** is converted to an infinitely precise floating-point integer. The result of the conversion is rounded to double-precision using the rounding mode specified by FPSCR[RN] and placed into register **frD**.

FPSCR[FPRF] is set to the class and sign of the result. FPSCR[FR] is set if the result is incremented when rounded. FPSCR[FI] is set if the result is inexact.

The conversion is described fully in Section D.4.3, “Floating-Point Convert from Integer Model.”

This instruction is defined only for 64-bit implementations. Using it on a 32-bit implementation will cause the system illegal instruction error handler to be invoked.

Other registers altered:

- Condition Register (CR1 field):
Affected: FX, VX, FEX, OX (if Rc = 1)
- Floating-point Status and Control Register:
Affected: FPRF, FR, FI, FX, XX

PowerPC Architecture Level	Supervisor Level	32-Bit	64-Bit	64-Bit Bridge	Optional	Form
UISA			√			X

fcmpo

Floating Compare Ordered

fcmpo

fcmpo **crfD,frA,frB**

Reserved

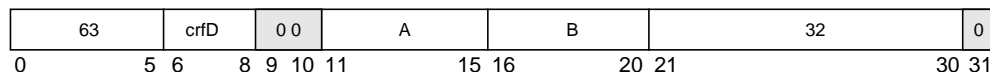

```

if (frA) is a NaN or
   (frB) is a NaN then c ← 0b0001
else if (frA) < (frB) then c ← 0b1000
else if (frA) > (frB) then c ← 0b0100
else c ← 0b0010

```

```

FPCC ← c
CR[4 * crfD - 4 * crfD + 3] ← c

```

```

if (frA) is an SNaN or
   (frB) is an SNaN then
   VXSNaN ← 1
   if VE = 0 then VXVC ← 1
else if (frA) is a QNaN or
   (frB) is a QNaN then VXVC ← 1

```

The floating-point operand in **frA** is compared to the floating-point operand in **frB**. The result of the compare is placed into CR field **crfD** and the FPCC.

If one of the operands is a NaN, either quiet or signaling, then CR field **crfD** and the FPCC are set to reflect unordered. If one of the operands is a signaling NaN, then VXSNaN is set, and if invalid operation is disabled (VE = 0) then VXVC is set. Otherwise, if one of the operands is a QNaN, then VXVC is set.

Other registers altered:

- Condition Register (CR field specified by operand **crfD**):
Affected: LT, GT, EQ, UN
- Floating-Point Status and Control Register:
Affected: FPCC, FX, VXSNaN, VXVC

PowerPC Architecture Level	Supervisor Level	32-Bit	64-Bit	64-Bit Bridge	Optional	Form
UISA						X

fcmpu

Floating Compare Unordered

fcmpu

fcmpu **crfD,frA,frB**

Reserved

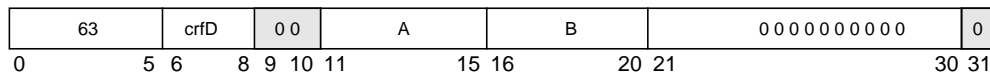

```

if (frA) is a NaN or
   (frB) is a NaN then c ← 0b0001
else if (frA) < (frB) then c ← 0b1000
else if (frA) > (frB) then c ← 0b0100
else c ← 0b0010
    
```

```

FPCC ← c
CR[4 * crfD - 4 * crfD + 3] ← c
    
```

```

if (frA) is an SNaN or
   (frB) is an SNaN then
    VXSNaN ← 1
    
```

The floating-point operand in register **frA** is compared to the floating-point operand in register **frB**. The result of the compare is placed into CR field **crfD** and the FPCC.

If one of the operands is a NaN, either quiet or signaling, then CR field **crfD** and the FPCC are set to reflect unordered. If one of the operands is a signaling NaN, then VXSNaN is set.

Other registers altered:

- Condition Register (CR field specified by operand **crfD**):
Affected: LT, GT, EQ, UN
- Floating-Point Status and Control Register:
Affected: FPCC, FX, VXSNaN

PowerPC Architecture Level	Supervisor Level	32-Bit	64-Bit	64-Bit Bridge	Optional	Form
UISA						X

fc_{tid}_x

64-Bit Implementations Only

fc_{tid}_x

Floating Convert to Integer Double Word

fc_{tid} **frD,frB** (Rc = 0)

fc_{tid.} **frD,frB** (Rc = 1)

Reserved



The floating-point operand in **frB** is converted to a 64-bit signed fixed-point integer, using the rounding mode specified by FPSCR[RN], and placed into **frD**.

If the operand in **frB** is greater than $2^{63} - 1$, then **frD** is set to 0x7FFF_FFFF_FFFF_FFFF. If the operand in **frB** is less than -2^{63} , then **frD** is set to 0x8000_0000_0000_0000.

Except for enabled invalid operation exceptions, FPSCR[FPRF] is undefined. FPSCR[FR] is set if the result is incremented when rounded. FPSCR[FI] is set if the result is inexact.

The conversion is described fully in Section D.4.2, “Floating-Point Convert to Integer Model.”

This instruction is defined only for 64-bit implementations. Using it on a 32-bit implementation will cause the system illegal instruction error handler to be invoked.

Other registers altered:

- Condition Register (CR1 field):
Affected: FX, FEX, VX, OX (if Rc = 1)
- Floating-Point Status and Control Register:
Affected: FPRF (undefined), FR, FI, FX, XX, VXSNaN, VXCvI

PowerPC Architecture Level	Supervisor Level	32-Bit	64-Bit	64-Bit Bridge	Optional	Form
UISA			√			X

ftidz_X

64-Bit Implementations Only

ftidz_X

Floating Convert to Integer Double Word with Round toward Zero

ftidz **frD,frB** (Rc = 0)

ftidz. **frD,frB** (Rc = 1)

Reserved

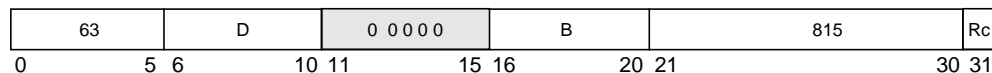

The floating-point operand in **frB** is converted to a 64-bit signed fixed-point integer, using the rounding mode round toward zero, and placed into **frD**.

If the operand in **frB** is greater than $2^{63} - 1$, then **frD** is set to 0x7FFF_FFFF_FFFF_FFFF. If the operand in **frB** is less than -2^{63} , then **frD** is set to 0x8000_0000_0000_0000.

Except for enabled invalid operation exceptions, FPSCR[FPRF] is undefined. FPSCR[FR] is set if the result is incremented when rounded. FPSCR[FI] is set if the result is inexact.

The conversion is described fully in Section D.4.2, "Floating-Point Convert to Integer Model."

This instruction is defined only for 64-bit implementations. Using it on a 32-bit implementation will cause the system illegal instruction error handler to be invoked.

Other registers altered:

- Condition Register (CR1 field):
Affected: FX, FEX, VX, OX (if Rc = 1)
- Floating-Point Status and Control Register:
Affected: FPRF (undefined), FR, FI, FX, XX, VXSNaN, VXCvI

PowerPC Architecture Level	Supervisor Level	32-Bit	64-Bit	64-Bit Bridge	Optional	Form
UISA			√			X

fctiw_X

Floating Convert to Integer Word

fctiw **frD,frB** (Rc = 0)

fctiw. **frD,frB** (Rc = 1)

fctiw_X

Reserved



The floating-point operand in register **frB** is converted to a 32-bit signed integer, using the rounding mode specified by FPSCR[RN], and placed in bits 32–63 of **frD**. Bits 0–31 of **frD** are undefined.

If the operand in **frB** are greater than $2^{31} - 1$, bits 32–63 of **frD** are set to 0x7FFF_FFFF.

If the operand in **frB** are less than -2^{31} , bits 32–63 of **frD** are set to 0x8000_0000.

The conversion is described fully in Section D.4.2, “Floating-Point Convert to Integer Model.”

Except for trap-enabled invalid operation exceptions, FPSCR[FPRF] is undefined. FPSCR[FR] is set if the result is incremented when rounded. FPSCR[FI] is set if the result is inexact.

Other registers altered:

- Condition Register (CR1 field):
Affected: FX, FEX, VX, OX (if Rc = 1)
- Floating-Point Status and Control Register:
Affected: FPRF (undefined), FR, FI, FX, XX, VXSNAN, VXCVI

PowerPC Architecture Level	Supervisor Level	32-Bit	64-Bit	64-Bit Bridge	Optional	Form
UISA						X

fctiwz_X

Floating Convert to Integer Word with Round toward Zero

fctiwz **frD,frB** (Rc = 0)

fctiwz. **frD,frB** (Rc = 1)

fctiwz_X

Reserved

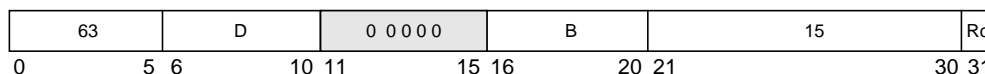

The floating-point operand in register **frB** is converted to a 32-bit signed integer, using the rounding mode round toward zero, and placed in bits 32–63 of **frD**. Bits 0–31 of **frD** are undefined.

If the operand in **frB** is greater than $2^{31} - 1$, bits 32–63 of **frD** are set to 0x7FFF_FFFF.

If the operand in **frB** is less than -2^{31} , bits 32–63 of **frD** are set to 0x 8000_0000.

The conversion is described fully in Section D.4.2, “Floating-Point Convert to Integer Model.”

Except for trap-enabled invalid operation exceptions, FPSCR[FPRF] is undefined. FPSCR[FR] is set if the result is incremented when rounded. FPSCR[FI] is set if the result is inexact.

Other registers altered:

- Condition Register (CR1 field):
Affected: FX, FEX, VX, OX (if Rc = 1)
- Floating-Point Status and Control Register:
Affected: FPRF (undefined), FR, FI, FX, XX, VXSNAN, VXCVI

PowerPC Architecture Level	Supervisor Level	32-Bit	64-Bit	64-Bit Bridge	Optional	Form
UISA						X

fdiv_x

Floating Divide (Double-Precision)

fdiv_x

fdiv **frD,frA,frB** (Rc = 0)

fdiv. **frD,frA,frB** (Rc = 1)

[POWER mnemonics: **fd**, **fd.**]

Reserved

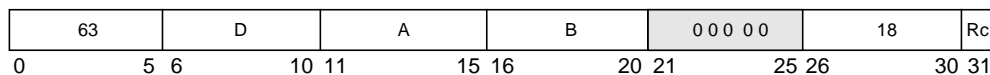

The floating-point operand in register **frA** is divided by the floating-point operand in register **frB**. The remainder is not supplied as a result.

If the most-significant bit of the resultant significand is not a one, the result is normalized. The result is rounded to double-precision under control of the floating-point rounding control field RN of the FPSCR and placed into **frD**.

Floating-point division is based on exponent subtraction and division of the significands.

FPSCR[FPRF] is set to the class and sign of the result, except for invalid operation exceptions when FPSCR[VE] = 1 and zero divide exceptions when FPSCR[ZE] = 1.

Other registers altered:

- Condition Register (CR1 field):
Affected: FX, FEX, VX, OX (if Rc = 1)
- Floating-Point Status and Control Register:
Affected: FPRF, FR, FI, FX, OX, UX, ZX, XX, VXSNaN, VXID, VXZDZ

PowerPC Architecture Level	Supervisor Level	32-Bit	64-Bit	64-Bit Bridge	Optional	Form
UISA						A

fdivs_X

Floating Divide Single

fdivs_X

fdivs **frD,frA,frB** (Rc = 0)

fdivs. **frD,frA,frB** (Rc = 1)

Reserved

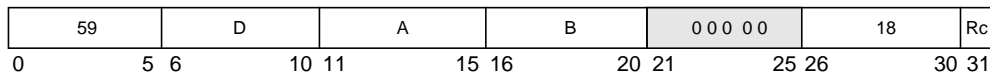

The floating-point operand in register **frA** is divided by the floating-point operand in register **frB**. The remainder is not supplied as a result.

If the most-significant bit of the resultant significand is not a one, the result is normalized. The result is rounded to single-precision under control of the floating-point rounding control field RN of the FPSCR and placed into **frD**.

Floating-point division is based on exponent subtraction and division of the significands.

FPSCR[FPRF] is set to the class and sign of the result, except for invalid operation exceptions when FPSCR[VE] = 1 and zero divide exceptions when FPSCR[ZE] = 1.

Other registers altered:

- Condition Register (CR1 field):
Affected: FX, FEX, VX, OX (if Rc = 1)
- Floating-Point Status and Control Register:
Affected: FPRF, FR, FI, FX, OX, UX, ZX, XX, VXSNAN, VXIDI, VXZDZ

PowerPC Architecture Level	Supervisor Level	32-Bit	64-Bit	64-Bit Bridge	Optional	Form
UISA						A

fmadd_x

Floating Multiply-Add (Double-Precision)

fmadd **frD,frA,frC,frB** (Rc = 0)

fmadd. **frD,frA,frC,frB** (Rc = 1)

[POWER mnemonics: **fma**, **fma.**]

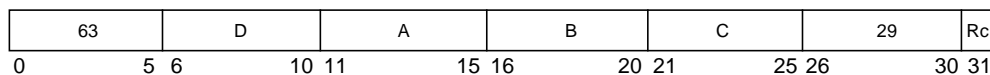

The following operation is performed:

$$\mathbf{frD} \leftarrow (\mathbf{frA} * \mathbf{frC}) + \mathbf{frB}$$

The floating-point operand in register **frA** is multiplied by the floating-point operand in register **frC**. The floating-point operand in register **frB** is added to this intermediate result.

If the most-significant bit of the resultant significand is not a one, the result is normalized. The result is rounded to double-precision under control of the floating-point rounding control field RN of the FPSCR and placed into **frD**.

FPSCR[FPRF] is set to the class and sign of the result, except for invalid operation exceptions when FPSCR[VE] = 1.

Other registers altered:

- Condition Register (CR1 field):
Affected: FX, FEX, VX, OX (if Rc = 1)
- Floating-Point Status and Control Register:
Affected: FPRF, FR, FI, FX, OX, UX, XX, VXSNaN, VXISI, VXIMZ

PowerPC Architecture Level	Supervisor Level	32-Bit	64-Bit	64-Bit Bridge	Optional	Form
----------------------------	------------------	--------	--------	---------------	----------	------

UISA						A
------	--	--	--	--	--	---

fmadds_X

Floating Multiply-Add Single

fmadds_X

fmadds **frD,frA,frC,frB** (**Rc** = 0)

fmadds. **frD,frA,frC,frB** (**Rc** = 1)

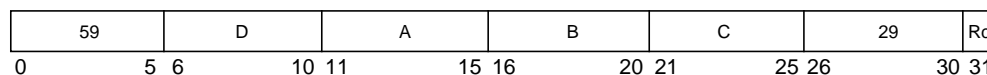

The following operation is performed:

$$\mathbf{frD} \leftarrow (\mathbf{frA} * \mathbf{frC}) + \mathbf{frB}$$

The floating-point operand in register **frA** is multiplied by the floating-point operand in register **frC**. The floating-point operand in register **frB** is added to this intermediate result.

If the most-significant bit of the resultant significand is not a one, the result is normalized. The result is rounded to single-precision under control of the floating-point rounding control field **RN** of the **FPSCR** and placed into **frD**.

FPSCR[FPRF] is set to the class and sign of the result, except for invalid operation exceptions when **FPSCR[VE]** = 1.

Other registers altered:

- Condition Register (CR1 field):
Affected: **FX, FEX, VX, OX** (if **Rc** = 1)
- Floating-Point Status and Control Register:
Affected: **FPRF, FR, FI, FX, OX, UX, XX, VXSNaN, VXISI, VXIMZ**

PowerPC Architecture Level	Supervisor Level	32-Bit	64-Bit	64-Bit Bridge	Optional	Form
UISA						A

fmr_X

Floating Move Register

fmr_X

fmr **frD,frB** (Rc = 0)

fmr. **frD,frB** (Rc = 1)

Reserved

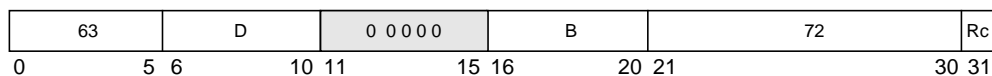

The contents of register **frB** are placed into **frD**.

Other registers altered:

- Condition Register (CR1 field):
Affected: FX, FEX, VX, OX (if Rc = 1)

PowerPC Architecture Level	Supervisor Level	32-Bit	64-Bit	64-Bit Bridge	Optional	Form
UISA						X

fmsub_x

Floating Multiply-Subtract (Double-Precision)

fmsub_x

fmsub **frD,frA,frC,frB** (Rc = 0)

fmsub. **frD,frA,frC,frB** (Rc = 1)

[POWER mnemonics: **fms**, **fms.**]

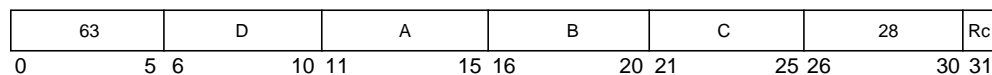

The following operation is performed:

$$\mathbf{frD} \leftarrow [\mathbf{frA} * \mathbf{frC}] - \mathbf{frB}$$

The floating-point operand in register **frA** is multiplied by the floating-point operand in register **frC**. The floating-point operand in register **frB** is subtracted from this intermediate result.

If the most-significant bit of the resultant significand is not a one, the result is normalized. The result is rounded to double-precision under control of the floating-point rounding control field RN of the FPSCR and placed into **frD**.

FPSCR[FPRF] is set to the class and sign of the result, except for invalid operation exceptions when FPSCR[VE] = 1.

Other registers altered:

- Condition Register (CR1 field):
Affected: FX, FEX, VX, OX (if Rc = 1)
- Floating-Point Status and Control Register:
Affected: FPRF, FR, FI, FX, OX, UX, XX, VXSNAN, VXISI, VXIMZ

PowerPC Architecture Level	Supervisor Level	32-Bit	64-Bit	64-Bit Bridge	Optional	Form
UISA						A

fmsubs_x

Floating Multiply-Subtract Single

fmsubs_x

fmsubs **frD,frA,frC,frB** (Rc = 0)

fmsubs. **frD,frA,frC,frB** (Rc = 1)

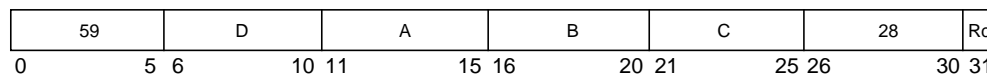

The following operation is performed:

$$\mathbf{frD} \leftarrow [\mathbf{frA} * \mathbf{frC}] - \mathbf{frB}$$

The floating-point operand in register **frA** is multiplied by the floating-point operand in register **frC**. The floating-point operand in register **frB** is subtracted from this intermediate result.

If the most-significant bit of the resultant significand is not a one, the result is normalized. The result is rounded to single-precision under control of the floating-point rounding control field RN of the FPSCR and placed into **frD**.

FPSCR[FPRF] is set to the class and sign of the result, except for invalid operation exceptions when FPSCR[VE] = 1.

Other registers altered:

- Condition Register (CR1 field):
Affected: FX, FEX, VX, OX (if Rc = 1)
- Floating-Point Status and Control Register:
Affected: FPRF, FR, FI, FX, OX, UX, XX, VXSNaN, VXISI, VXIMZ

PowerPC Architecture Level	Supervisor Level	32-Bit	64-Bit	64-Bit Bridge	Optional	Form
UIA						A

fmul_x

Floating Multiply (Double-Precision)

fmul_x

fmul **frD,frA,frC** (Rc = 0)

fmul. **frD,frA,frC** (Rc = 1)

[POWER mnemonics: **fm**, **fm.**]

Reserved

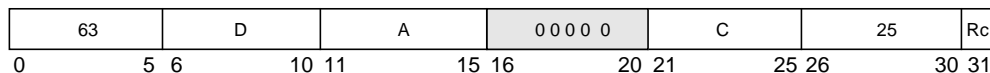

The floating-point operand in register **frA** is multiplied by the floating-point operand in register **frC**.

If the most-significant bit of the resultant significand is not a one, the result is normalized. The result is rounded to double-precision under control of the floating-point rounding control field RN of the FPSCR and placed into **frD**.

Floating-point multiplication is based on exponent addition and multiplication of the significands.

FPSCR[FPRF] is set to the class and sign of the result, except for invalid operation exceptions when FPSCR[VE] = 1.

Other registers altered:

- Condition Register (CR1 field):
Affected: FX, FEX, VX, OX (if Rc = 1)
- Floating-Point Status and Control Register:
Affected: FPRF, FR, FI, FX, OX, UX, XX, VXSNAN, VXIMZ

PowerPC Architecture Level	Supervisor Level	32-Bit	64-Bit	64-Bit Bridge	Optional	Form
UISA						A

fmuls_x

Floating Multiply Single

fmuls_x

fmuls **frD,frA,frC** (Rc = 0)

fmuls. **frD,frA,frC** (Rc = 1)

Reserved

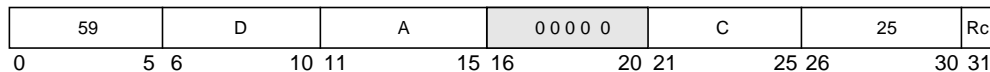

The floating-point operand in register **frA** is multiplied by the floating-point operand in register **frC**.

If the most-significant bit of the resultant significand is not a one, the result is normalized. The result is rounded to single-precision under control of the floating-point rounding control field RN of the FPSCR and placed into **frD**.

Floating-point multiplication is based on exponent addition and multiplication of the significands.

FPSCR[FPRF] is set to the class and sign of the result, except for invalid operation exceptions when FPSCR[VE] = 1.

Other registers altered:

- Condition Register (CR1 field):
Affected: FX, FEX, VX, OX (if Rc = 1)
- Floating-Point Status and Control Register:
Affected: FPRF, FR, FI, FX, OX, UX, XX, VXSNAN, VXIMZ

PowerPC Architecture Level	Supervisor Level	32-Bit	64-Bit	64-Bit Bridge	Optional	Form
UISA						A

fnabs_x

Floating Negative Absolute Value

fnabs_x

fnabs **frD,frB** (Rc = 0)

fnabs. **frD,frB** (Rc = 1)

Reserved



The contents of register **frB** with bit 0 set are placed into **frD**.

Note that the **fnabs** instruction treats NaNs just like any other kind of value. That is, the sign bit of a NaN may be altered by **fnabs**. This instruction does not alter the FPSCR.

Other registers altered:

- Condition Register (CR1 field):
Affected: FX, FEX, VX, OX (if Rc = 1)

PowerPC Architecture Level	Supervisor Level	32-Bit	64-Bit	64-Bit Bridge	Optional	Form
UISA						X

fnmadd_x

Floating Negative Multiply-Add (Double-Precision)

fnmadd **frD,frA,frC,frB** (Rc = 0)

fnmadd. **frD,frA,frC,frB** (Rc = 1)

[POWER mnemonics: **fnma**, **fnma.**]

fnmadd_x

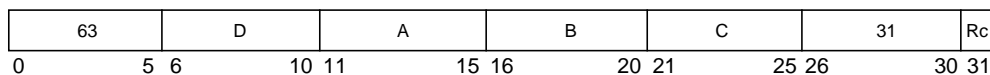

The following operation is performed:

$$\mathbf{frD} \leftarrow - ([\mathbf{frA} * \mathbf{frC}] + \mathbf{frB})$$

The floating-point operand in register **frA** is multiplied by the floating-point operand in register **frC**. The floating-point operand in register **frB** is added to this intermediate result. If the most-significant bit of the resultant significand is not a one, the result is normalized. The result is rounded to double-precision under control of the floating-point rounding control field RN of the FPSCR, then negated and placed into **frD**.

This instruction produces the same result as would be obtained by using the Floating Multiply-Add (**fmadd_x**) instruction and then negating the result, with the following exceptions:

- QNaNs propagate with no effect on their sign bit.
- QNaNs that are generated as the result of a disabled invalid operation exception have a sign bit of zero.
- SNaNs that are converted to QNaNs as the result of a disabled invalid operation exception retain the sign bit of the SNaN.

FPSCR[FPRF] is set to the class and sign of the result, except for invalid operation exceptions when FPSCR[VE] = 1.

Other registers altered:

- Condition Register (CR1 field):
Affected: FX, FEX, VX, OX (if Rc = 1)
- Floating-Point Status and Control Register:
Affected: FPRF, FR, FI, FX, OX, UX, XX, VXSNAN, VXISI, VXIMZ

PowerPC Architecture Level	Supervisor Level	32-Bit	64-Bit	64-Bit Bridge	Optional	Form
UISA						A

fnmaddsx

Floating Negative Multiply-Add Single

fnmaddsx

fnmadds **frD,frA,frC,frB** (Rc = 0)

fnmadds. **frD,frA,frC,frB** (Rc = 1)

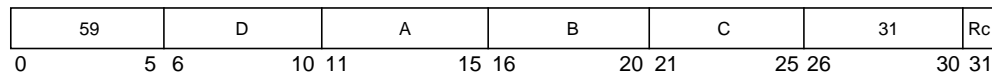

The following operation is performed:

$$\mathbf{frD} \leftarrow - ([\mathbf{frA} * \mathbf{frC}] + \mathbf{frB})$$

The floating-point operand in register **frA** is multiplied by the floating-point operand in register **frC**. The floating-point operand in register **frB** is added to this intermediate result. If the most-significant bit of the resultant significand is not a one, the result is normalized. The result is rounded to single-precision under control of the floating-point rounding control field RN of the FPSCR, then negated and placed into **frD**.

This instruction produces the same result as would be obtained by using the Floating Multiply-Add Single (**fmaddsx**) instruction and then negating the result, with the following exceptions:

- QNaNs propagate with no effect on their sign bit.
- QNaNs that are generated as the result of a disabled invalid operation exception have a sign bit of zero.
- SNaNs that are converted to QNaNs as the result of a disabled invalid operation exception retain the sign bit of the SNaN.

FPSCR[FPRF] is set to the class and sign of the result, except for invalid operation exceptions when FPSCR[VE] = 1.

Other registers altered:

- Condition Register (CR1 field):
Affected: FX, FEX, VX, OX (if Rc = 1)
- Floating-Point Status and Control Register:
Affected: FPRF, FR, FI, FX, OX, UX, XX, VXSNAN, VXISI, VXIMZ

PowerPC Architecture Level Supervisor Level 32-Bit 64-Bit 64-Bit Bridge Optional Form

UISA						A
------	--	--	--	--	--	---

fnmsub_x

Floating Negative Multiply-Subtract (Double-Precision)

fnmsub **frD,frA,frC,frB** (Rc = 0)

fnmsub. **frD,frA,frC,frB** (Rc = 1)

[POWER mnemonics: **fnms**, **fnms.**]

fnmsub_x



The following operation is performed:

$$\mathbf{frD} \leftarrow - ([\mathbf{frA} * \mathbf{frC}] - \mathbf{frB})$$

The floating-point operand in register **frA** is multiplied by the floating-point operand in register **frC**. The floating-point operand in register **frB** is subtracted from this intermediate result.

If the most-significant bit of the resultant significand is not one, the result is normalized. The result is rounded to double-precision under control of the floating-point rounding control field RN of the FPSCR, then negated and placed into **frD**.

This instruction produces the same result obtained by negating the result of a Floating Multiply-Subtract (**fmsub_x**) instruction with the following exceptions:

- QNaNs propagate with no effect on their sign bit.
- QNaNs that are generated as the result of a disabled invalid operation exception have a sign bit of zero.
- SNaNs that are converted to QNaNs as the result of a disabled invalid operation exception retain the sign bit of the SNaN.

FPSCR[FPRF] is set to the class and sign of the result, except for invalid operation exceptions when FPSCR[VE] = 1.

Other registers altered:

- Condition Register (CR1 field)
Affected: FX, FEX, VX, OX (if Rc = 1)
- Floating-Point Status and Control Register:
Affected: FPRF, FR, FI, FX, OX, UX, XX, VXSNAN, VXISI, VXIMZ

PowerPC Architecture Level	Supervisor Level	32-Bit	64-Bit	64-Bit Bridge	Optional	Form
UISA						A

fnmsubs_x

Floating Negative Multiply-Subtract Single

fnmsubs **frD,frA,frC,frB** (Rc = 0)

fnmsubs. **frD,frA,frC,frB** (Rc = 1)

fnmsubs_x

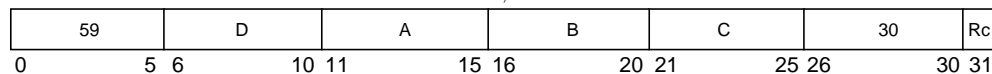

The following operation is performed:

$$\mathbf{frD} \leftarrow - ([\mathbf{frA} * \mathbf{frC}] - \mathbf{frB})$$

The floating-point operand in register **frA** is multiplied by the floating-point operand in register **frC**. The floating-point operand in register **frB** is subtracted from this intermediate result.

If the most-significant bit of the resultant significand is not one, the result is normalized. The result is rounded to single-precision under control of the floating-point rounding control field RN of the FPSCR, then negated and placed into **frD**.

This instruction produces the same result obtained by negating the result of a Floating Multiply-Subtract Single (**fmsubs_x**) instruction with the following exceptions:

- QNaNs propagate with no effect on their sign bit.
- QNaNs that are generated as the result of a disabled invalid operation exception have a sign bit of zero.
- SNaNs that are converted to QNaNs as the result of a disabled invalid operation exception retain the sign bit of the SNaN.

FPSCR[FPRF] is set to the class and sign of the result, except for invalid operation exceptions when FPSCR[VE] = 1.

Other registers altered:

- Condition Register (CR1 field)
Affected: FX, FEX, VX, OX (if Rc = 1)
- Floating-Point Status and Control Register:
Affected: FPRF, FR, FI, FX, OX, UX, XX, VXSNaN, VXISI, VXIMZ

PowerPC Architecture Level	Supervisor Level	32-Bit	64-Bit	64-Bit Bridge	Optional	Form
UISA						A

fres_x

Floating Reciprocal Estimate Single

fres_x

fres **frD,frB** (Rc = 0)

fres. **frD,frB** (Rc = 1)

☐ Reserved

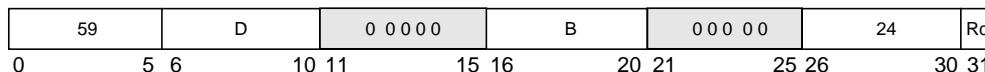

A single-precision estimate of the reciprocal of the floating-point operand in register **frB** is placed into register **frD**. The estimate placed into register **frD** is correct to a precision of one part in 256 of the reciprocal of **frB**. That is,

$$ABS \left(\frac{estimate - \left(\frac{1}{x}\right)}{\left(\frac{1}{x}\right)} \right) \leq \frac{1}{256}$$

where x is the initial value in **frB**. Note that the value placed into register **frD** may vary between implementations, and between different executions on the same implementation.

Operation with various special values of the operand is summarized below:

<u>Operand</u>	<u>Result</u>	<u>Exception</u>
−∞	−0	None
−0	−∞*	ZX
+0	+∞*	ZX
+∞	+0	None
SNaN	QNaN**	VXSNAN
QNaN	QNaN	None

Notes: * No result if FPSCR[ZE] = 1

** No result if FPSCR[VE] = 1

FPSCR[FPRF] is set to the class and sign of the result, except for invalid operation exceptions when FPSCR[VE] = 1 and zero divide exceptions when FPSCR[ZE] = 1.

Note that the PowerPC architecture makes no provision for a double-precision version of the **fres_x** instruction. This is because graphics applications are expected to need only the single-precision version, and no other important performance-critical applications are expected to require a double-precision version of the **fres_x** instruction.

This instruction is optional in the PowerPC architecture.

Other registers altered:

- Condition Register (CR1 field):
Affected: FX, FEX, VX, OX (if Rc = 1)
- Floating-Point Status and Control Register:
Affected: FPRF, FR (undefined), FI (undefined), FX, OX, UX, ZX, VXSNaN

PowerPC Architecture Level	Supervisor Level	32-Bit	64-Bit	64-Bit Bridge	Optional	Form
UIA					√	A

frsp_x

Floating Round to Single

frsp_x

frsp **frD,frB** (Rc = 0)

frsp. **frD,frB** (Rc = 1)

Reserved

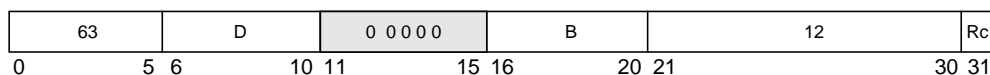

The floating-point operand in register **frB** is rounded to single-precision using the rounding mode specified by FPSCR[RN] and placed into **frD**.

The rounding is described fully in Section D.4.1, “Floating-Point Round to Single-Precision Model.”

FPSCR[FPRF] is set to the class and sign of the result, except for invalid operation exceptions when FPSCR[VE] = 1.

Other registers altered:

- Condition Register (CR1 field):
Affected: FX, FEX, VX, OX (if Rc = 1)
- Floating-Point Status and Control Register:
Affected: FPRF, FR, FI, FX, OX, UX, XX, VXSNaN

PowerPC Architecture Level	Supervisor Level	32-Bit	64-Bit	64-Bit Bridge	Optional	Form
UISA						X

frsqrte_x

Floating Reciprocal Square Root Estimate

frsqrte_x

frsqrte **frD,frB** (Rc = 0)

frsqrte. **frD,frB** (Rc = 1)

□ Reserved



A double-precision estimate of the reciprocal of the square root of the floating-point operand in register **frB** is placed into register **frD**. The estimate placed into register **frD** is correct to a precision of one part in 32 of the reciprocal of the square root of **frB**. That is,

$$ABS \left(\frac{estimate - \left(\frac{1}{\sqrt{x}}\right)}{\left(\frac{1}{\sqrt{x}}\right)} \right) \leq \frac{1}{32}$$

where *x* is the initial value in **frB**. Note that the value placed into register **frD** may vary between implementations, and between different executions on the same implementation.

Operation with various special values of the operand is summarized below:

Operand	Result	Exception
−∞	QNaN**	VXSQRT
<0	QNaN**	VXSQRT
−0	−∞*	ZX
+0	+∞*	ZX
+∞	+0	None
SNaN	QNaN**	VXSNAN
QNaN	QNaN	None

Notes: * No result if FPSCR[ZE] = 1

** No result if FPSCR[VE] = 1

FPSCR[FPRF] is set to the class and sign of the result, except for invalid operation exceptions when FPSCR[VE] = 1 and zero divide exceptions when FPSCR[ZE] = 1.

Note that no single-precision version of the **frsqrte** instruction is provided; however, both **frB** and **frD** are representable in single-precision format.

This instruction is optional in the PowerPC architecture.

Other registers altered:

- Condition Register (CR1 field):
Affected: FX, FEX, VX, OX (if Rc = 1)
- Floating-Point Status and Control Register:
Affected: FPRF, FR (undefined), FI (undefined), FX, ZX, VXSNaN, VXSQRT

PowerPC Architecture Level	Supervisor Level	32-Bit	64-Bit	64-Bit Bridge	Optional	Form
UIA					√	A

fsel_x

Floating Select

fsel_x

fsel **frD,frA,frC,frB** (Rc = 0)

fsel. **frD,frA,frC,frB** (Rc = 1)

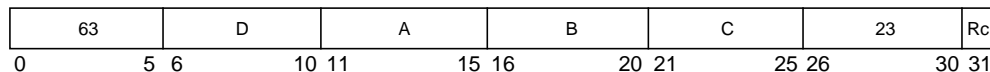

```

if (frA) ≥ 0.0 then frD ← (frC)
else frD ← (frB)

```

The floating-point operand in register **frA** is compared to the value zero. If the operand is greater than or equal to zero, register **frD** is set to the contents of register **frC**. If the operand is less than zero or is a NaN, register **frD** is set to the contents of register **frB**. The comparison ignores the sign of zero (that is, regards +0 as equal to -0).

Care must be taken in using **fsel** if IEEE compatibility is required, or if the values being tested can be NaNs or infinities.

For examples of uses of this instruction, see Section D.3, “Floating-Point Conversions,” and Section D.5, “Floating-Point Selection.”

This instruction is optional in the PowerPC architecture.

Other registers altered:

- Condition Register (CR1 field):
Affected: FX, FEX, VX, OX (if Rc = 1)

PowerPC Architecture Level	Supervisor Level	32-Bit	64-Bit	64-Bit Bridge	Optional	Form
UIA					√	A

fsqrt_x

Floating Square Root (Double-Precision)

fsqrt_x

fsqrt **frD,frB** (Rc = 0)

fsqrt. **frD,frB** (Rc = 1)

Reserved

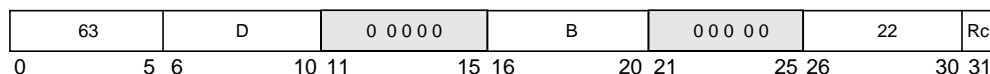

The square root of the floating-point operand in register **frB** is placed into register **frD**.

If the most-significant bit of the resultant significand is not a one the result is normalized. The result is rounded to the target precision under control of the floating-point rounding control field RN of the FPSCR and placed into register **frD**.

Operation with various special values of the operand is summarized below:

<u>Operand</u>	<u>Result</u>	<u>Exception</u>
$-\infty$	QNaN*	VXSQRT
<0	QNaN*	VXSQRT
-0	-0	None
$+\infty$	$+\infty$	None
SNaN	QNaN*	VXSNAN
QNaN	QNaN	None

Notes: * No result if FPSCR[VE] = 1

FPSCR[FPRF] is set to the class and sign of the result, except for invalid operation exceptions when FPSCR[VE] = 1.

This instruction is optional in the PowerPC architecture.

Other registers altered:

- Condition Register (CR1 field):
Affected: FX, FEX, VX, OX (if Rc = 1)
- Floating-Point Status and Control Register:
Affected: FPRF, FR, FI, FX, XX, VXSNAN, VXSQRT

PowerPC Architecture Level	Supervisor Level	32-Bit	64-Bit	64-Bit Bridge	Optional	Form
UISA					√	A

fsqrts_x

Floating Square Root Single

fsqrts_x

fsqrts **frD,frB** (Rc = 0)
fsqrts. **frD,frB** (Rc = 1)

Reserved

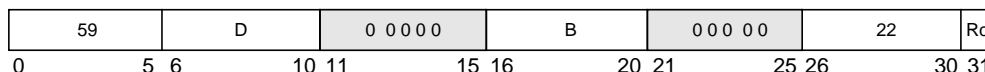

The square root of the floating-point operand in register **frB** is placed into register **frD**.

If the most-significant bit of the resultant significand is not a one the result is normalized. The result is rounded to the target precision under control of the floating-point rounding control field RN of the FPSCR and placed into register **frD**.

Operation with various special values of the operand is summarized below.

<u>Operand</u>	<u>Result</u>	<u>Exception</u>
$-\infty$	QNaN*	VXSQRT
<0	QNaN*	VXSQRT
-0	-0	None
$+\infty$	$+\infty$	None
SNaN	QNaN*	VXSNAN
QNaN	QNaN	None

Notes: * No result if FPSCR[VE] = 1

FPSCR[FPRF] is set to the class and sign of the result, except for invalid operation exceptions when FPSCR[VE] = 1.

This instruction is optional in the PowerPC architecture.

Other registers altered:

- Condition Register (CR1 field):
Affected: FX, FEX, VX, OX (if Rc = 1)
- Floating-Point Status and Control Register:
Affected: FPRF, FR, FI, FX, XX, VXSNAN, VXSQRT

PowerPC Architecture Level	Supervisor Level	32-Bit	64-Bit	64-Bit Bridge	Optional	Form
UISA					√	A

fsub_x

Floating Subtract (Double-Precision)

fsub **frD,frA,frB** (Rc = 0)

fsub. **frD,frA,frB** (Rc = 1)

[POWER mnemonics: **fs**, **fs.**]

fsub_x

Reserved

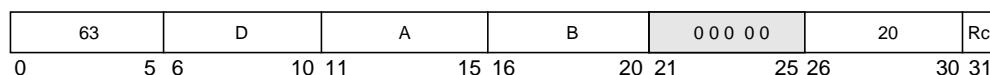

The floating-point operand in register **frB** is subtracted from the floating-point operand in register **frA**. If the most-significant bit of the resultant significand is not a one, the result is normalized. The result is rounded to double-precision under control of the floating-point rounding control field RN of the FPSCR and placed into **frD**.

The execution of the **fsub** instruction is identical to that of **fadd**, except that the contents of **frB** participate in the operation with its sign bit (bit 0) inverted.

FPSCR[FPRF] is set to the class and sign of the result, except for invalid operation exceptions when FPSCR[VE] = 1.

Other registers altered:

- Condition Register (CR1 field):
Affected: FX, FEX, VX, OX (if Rc = 1)
- Floating-Point Status and Control Register:
Affected: FPRF, FR, FI, FX, OX, UX, XX, VXSNaN, VXISI

PowerPC Architecture Level	Supervisor Level	32-Bit	64-Bit	64-Bit Bridge	Optional	Form
UISA						A

fsubs_x

Floating Subtract Single

fsubs_x

fsubs **frD,frA,frB** (Rc = 0)

fsubs. **frD,frA,frB** (Rc = 1)

Reserved

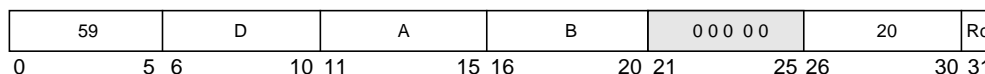

The floating-point operand in register **frB** is subtracted from the floating-point operand in register **frA**. If the most-significant bit of the resultant significand is not a one, the result is normalized. The result is rounded to single-precision under control of the floating-point rounding control field RN of the FPSCR and placed into **frD**.

The execution of the **fsubs** instruction is identical to that of **fadds**, except that the contents of **frB** participate in the operation with its sign bit (bit 0) inverted.

FPSCR[FPRF] is set to the class and sign of the result, except for invalid operation exceptions when FPSCR[VE] = 1.

Other registers altered:

- Condition Register (CR1 field):
Affected: FX, FEX, VX, OX (if Rc = 1)
- Floating-Point Status and Control Register:
Affected: FPRF, FR, FI, FX, OX, UX, XX, VXSNAN, VXISI

PowerPC Architecture Level	Supervisor Level	32-Bit	64-Bit	64-Bit Bridge	Optional	Form
UISA						A

isync

Instruction Synchronize

isync

isync

[POWER mnemonic: **ics**]

Reserved

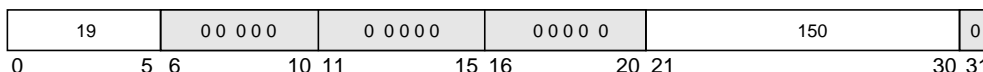

The **isync** instruction provides an ordering function for the effects of all instructions executed by a processor. Executing an **isync** instruction ensures that all instructions preceding the **isync** instruction have completed before the **isync** instruction completes, except that memory accesses caused by those instructions need not have been performed with respect to other processors and mechanisms. It also ensures that no subsequent instructions are initiated by the processor until after the **isync** instruction completes. Finally, it causes the processor to discard any prefetched instructions, with the effect that subsequent instructions will be fetched and executed in the context established by the instructions preceding the **isync** instruction. The **isync** instruction has no effect on the other processors or on their caches.

This instruction is context synchronizing.

Context synchronization is necessary after certain code sequences that perform complex operations within the processor. These code sequences are usually operating system tasks that involve memory management. For example, if an instruction A changes the memory translation rules in the memory management unit (MMU), the **isync** instruction should be executed so that the instructions following instruction A will be discarded from the pipeline and refetched according to the new translation rules.

Note that all exceptions and the **rfi** and **rfid** instructions are also context synchronizing.

Other registers altered:

- None

PowerPC Architecture Level	Supervisor Level	32-Bit	64-Bit	64-Bit Bridge	Optional	Form
----------------------------	------------------	--------	--------	---------------	----------	------

VEA						XL
-----	--	--	--	--	--	----

lbz

Load Byte and Zero

lbz

lbz $rD, d(rA)$

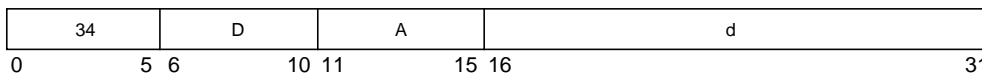

```

if rA = 0 then b ← 0
else      b ← (rA)
EA ← b + EXTS(d)
rD ← (56)0 || MEM(EA, 1)

```

EA is the sum $(rA|0) + d$. The byte in memory addressed by EA is loaded into the low-order eight bits of rD. The remaining bits in rD are cleared.

Other registers altered:

- None

PowerPC Architecture Level	Supervisor Level	32-Bit	64-Bit	64-Bit Bridge	Optional	Form
UIA						D

lbzu

Load Byte and Zero with Update

lbzu

lbzu **rD,d(rA)**

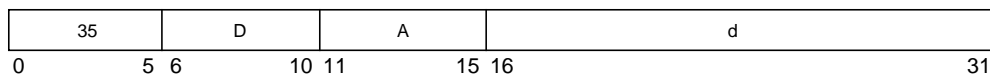

```
EA ← (rA) + EXTS(d)
rD ← (56)0 || MEM(EA, 1)
rA ← EA
```

EA is the sum (rA) + d. The byte in memory addressed by EA is loaded into the low-order eight bits of rD. The remaining bits in rD are cleared.

EA is placed into rA.

If rA = 0, or rA = rD, the instruction form is invalid.

Other registers altered:

- None

PowerPC Architecture Level	Supervisor Level	32-Bit	64-Bit	64-Bit Bridge	Optional	Form
----------------------------	------------------	--------	--------	---------------	----------	------

UISA						D
------	--	--	--	--	--	---

l**bzux**

Load Byte and Zero with Update Indexed

lbzux**** **rD,rA,rB**

l**bzux**

Reserved

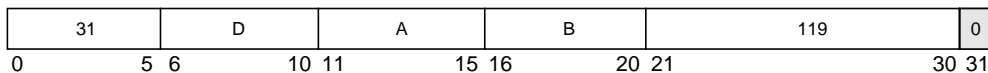

```
EA ← (rA) + (rB)
rD ← (56)0 || MEM(EA, 1)
rA ← EA
```

EA is the sum (rA) + (rB). The byte in memory addressed by EA is loaded into the low-order eight bits of rD. The remaining bits in rD are cleared.

EA is placed into rA.

If rA = 0 or rA = rD, the instruction form is invalid.

Other registers altered:

- None

PowerPC Architecture Level	Supervisor Level	32-Bit	64-Bit	64-Bit Bridge	Optional	Form
----------------------------	------------------	--------	--------	---------------	----------	------

UISA						X
------	--	--	--	--	--	---

lbzx

Load Byte and Zero Indexed

lbzx

lbzx rD, rA, rB

Reserved

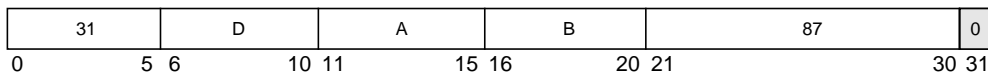

```

if rA = 0 then b ← 0
else      b ← (rA)
EA ← b + (rB)
rD ← (56)0 || MEM(EA, 1)

```

EA is the sum $(rA|0) + (rB)$. The byte in memory addressed by EA is loaded into the low-order eight bits of rD . The remaining bits in rD are cleared.

Other registers altered:

- None

PowerPC Architecture Level	Supervisor Level	32-Bit	64-Bit	64-Bit Bridge	Optional	Form
----------------------------	------------------	--------	--------	---------------	----------	------

UISA						X
------	--	--	--	--	--	---

ld**64-Bit Implementations Only****ld**

Load Double Word

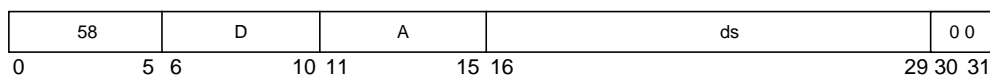
ld $rD, ds(rA)$ 

```

if rA = 0 then b ← 0
else      b ← (rA)
EA ← b + EXTS(ds || 0b00)
rD ← MEM(EA, 8)

```

EA is the sum $(rA|0) + (ds || 0b00)$. The double word in memory addressed by EA is loaded into rD.

This instruction is defined only for 64-bit implementations. Using it on a 32-bit implementation will cause the system illegal instruction error handler to be invoked.

Other registers altered:

- None

PowerPC Architecture Level	Supervisor Level	32-Bit	64-Bit	64-Bit Bridge	Optional	Form
UISA			√			DS

ldarx

64-Bit Implementations Only

ldarx

Load Double Word and Reserve Indexed

ldarx rD, rA, rB

Reserved

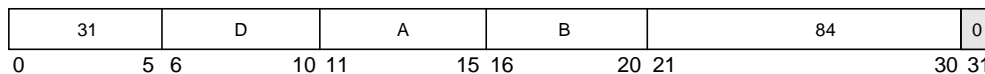

```

if rA = 0 then b ← 0
else    b ← (rA)
EA ← b + (rB)
RESERVE ← 1
RESERVE_ADDR ← physical_addr(EA)
rD ← MEM(EA, 8)

```

EA is the sum $(rA|0) + (rB)$. The double word in memory addressed by EA is loaded into **rD**.

This instruction creates a reservation for use by a Store Double Word Conditional Indexed (**stdcx.**) instruction. An address computed from the EA is associated with the reservation, and replaces any address previously associated with the reservation.

EA must be a multiple of eight. If it is not, either the system alignment exception handler is invoked or the results are boundedly undefined. For additional information about alignment and DSI exceptions, see Section 6.4.3, “DSI Exception (0x00300).”

This instruction is defined only for 64-bit implementations. Using it on a 32-bit implementation will cause the system illegal instruction error handler to be invoked.

Other registers altered:

- None

PowerPC Architecture Level	Supervisor Level	32-Bit	64-Bit	64-Bit Bridge	Optional	Form
UISA			√			X

ldu

64-Bit Implementations Only

ldu

Load Double Word with Update

ldu

rD,ds(rA)

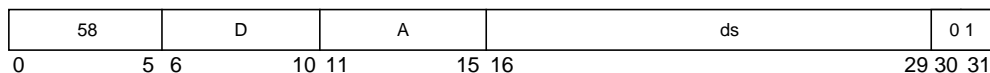

```

EA ← (rA) + EXT5(ds || 0b00)
rD ← MEM(EA, 8)
rA ← EA

```

EA is the sum (rA) + (ds || 0b00). The double word in memory addressed by EA is loaded into rD.

EA is placed into rA.

If rA = 0 or rA = rD, the instruction form is invalid.

This instruction is defined only for 64-bit implementations. Using it on a 32-bit implementation will cause the system illegal instruction error handler to be invoked.

Other registers altered:

- None

PowerPC Architecture Level	Supervisor Level	32-Bit	64-Bit	64-Bit Bridge	Optional	Form
UISA			√			DS

ldux

64-Bit Implementations Only

ldux_x

Load Double Word with Update Indexed

ldux **rD,rA,rB**

Reserved

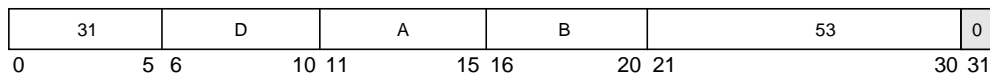

$EA \leftarrow (rA) + (rB)$

$rD \leftarrow MEM(EA, 8)$

$rA \leftarrow EA$

EA is the sum (rA) + (rB). The double word in memory addressed by EA is loaded into rD.

EA is placed into rA.

If rA = 0 or rA = rD, the instruction form is invalid.

This instruction is defined only for 64-bit implementations. Using it on a 32-bit implementation will cause the system illegal instruction to be invoked.

Other registers altered:

- None

PowerPC Architecture Level	Supervisor Level	32-Bit	64-Bit	64-Bit Bridge	Optional	Form
----------------------------	------------------	--------	--------	---------------	----------	------

UISA			√			X
------	--	--	---	--	--	---

ldx

64-Bit Implementations Only

ldx

Load Double Word Indexed

ldx rD, rA, rB

Reserved

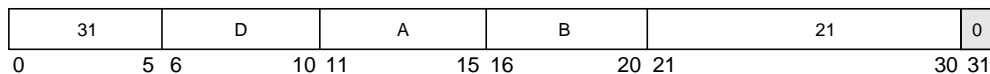

```

if  $rA = 0$  then  $b \leftarrow 0$ 
else  $b \leftarrow (rA)$ 
 $EA \leftarrow b + (rB)$ 
 $rD \leftarrow MEM(EA, 8)$ 

```

EA is the sum $(rA|0) + (rB)$. The double word in memory addressed by EA is loaded into **rD**.

This instruction is defined only for 64-bit implementations. Using it on a 32-bit implementation will cause the system illegal instruction error handler to be invoked.

Other registers altered:

- None

PowerPC Architecture Level	Supervisor Level	32-Bit	64-Bit	64-Bit Bridge	Optional	Form
----------------------------	------------------	--------	--------	---------------	----------	------

UISA			√			X
------	--	--	---	--	--	---

lfd

Load Floating-Point Double

lfd

lfd **frD,d(rA)**

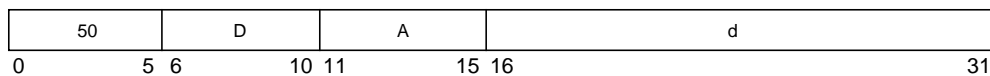

```

if rA = 0 then b ← 0
else b ← (rA)
EA ← b + EXTS(d)
frD ← MEM(EA, 8)

```

EA is the sum (rA|0) + d.

The double word in memory addressed by EA is placed into frD.

Other registers altered:

- None

PowerPC Architecture Level	Supervisor Level	32-Bit	64-Bit	64-Bit Bridge	Optional	Form
----------------------------	------------------	--------	--------	---------------	----------	------

UISA						D
------	--	--	--	--	--	---

lfd

Load Floating-Point Double with Update

lfd

lfd **frD,d(rA)**

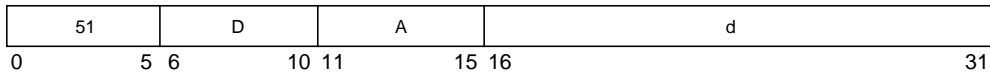

```
EA ← (rA) + EXTS(d)
frD ← MEM(EA, 8)
rA ← EA
```

EA is the sum (rA) + d.

The double word in memory addressed by EA is placed into frD.

EA is placed into rA.

If rA = 0, the instruction form is invalid.

Other registers altered:

- None

PowerPC Architecture Level	Supervisor Level	32-Bit	64-Bit	64-Bit Bridge	Optional	Form
----------------------------	------------------	--------	--------	---------------	----------	------

UISA						D
------	--	--	--	--	--	---

lfdx

Load Floating-Point Double with Update Indexed

lfdx

lfdx **frD,rA,rB**

Reserved

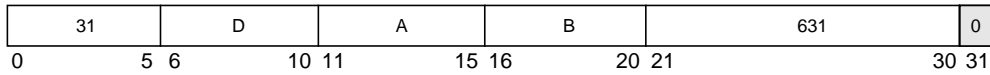

$EA \leftarrow (rA) + (rB)$
 $frD \leftarrow MEM(EA, 8)$
 $rA \leftarrow EA$

EA is the sum (rA) + (rB).

The double word in memory addressed by EA is placed into frD.

EA is placed into rA.

If rA = 0, the instruction form is invalid.

Other registers altered:

- None

PowerPC Architecture Level	Supervisor Level	32-Bit	64-Bit	64-Bit Bridge	Optional	Form
----------------------------	------------------	--------	--------	---------------	----------	------

UISA						X
------	--	--	--	--	--	---

lfdx

Load Floating-Point Double Indexed

lfdx

lfdx **frD,rA,rB**

Reserved

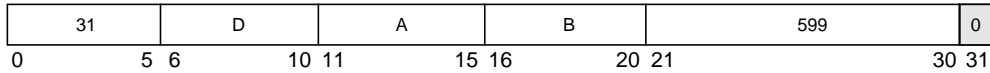

```

if rA = 0 then b ← 0
else      b ← (rA)
EA ← b + (rB)
frD ← MEM(EA, 8)

```

EA is the sum (rA[0] + (rB)).

The double word in memory addressed by EA is placed into frD.

Other registers altered:

- None

PowerPC Architecture Level	Supervisor Level	32-Bit	64-Bit	64-Bit Bridge	Optional	Form
----------------------------	------------------	--------	--------	---------------	----------	------

UISA						X
------	--	--	--	--	--	---

lfs

lfs

Load Floating-Point Single

lfs **frD,d(rA)**

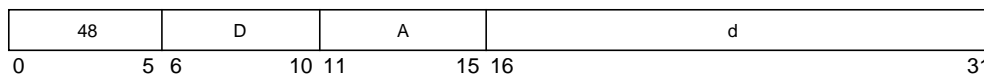

```

if rA = 0 then b ← 0
else      b ← (rA)
EA ← b + EXTS(d)
frD ← DOUBLE(MEM(EA, 4))

```

EA is the sum (rA|0) + d.

The word in memory addressed by EA is interpreted as a floating-point single-precision operand. This word is converted to floating-point double-precision (see Section D.6, “Floating-Point Load Instructions”) and placed into frD.

Other registers altered:

- None

PowerPC Architecture Level	Supervisor Level	32-Bit	64-Bit	64-Bit Bridge	Optional	Form
----------------------------	------------------	--------	--------	---------------	----------	------

UISA						D
------	--	--	--	--	--	---

lfsu

Load Floating-Point Single with Update

lfsu

lfsu **frD,d(rA)**

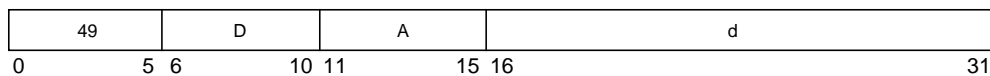

```

EA ← (rA) + EXTS(d)
frD ← DOUBLE(MEM(EA, 4))
rA ← EA

```

EA is the sum (rA) + d.

The word in memory addressed by EA is interpreted as a floating-point single-precision operand. This word is converted to floating-point double-precision (see Section D.6, “Floating-Point Load Instructions”) and placed into frD.

EA is placed into rA.

If rA = 0, the instruction form is invalid.

Other registers altered:

- None

PowerPC Architecture Level	Supervisor Level	32-Bit	64-Bit	64-Bit Bridge	Optional	Form
UI5A						D

lfsux

Load Floating-Point Single with Update Indexed

lfsux **frD,rA,rB**

lfsux

Reserved

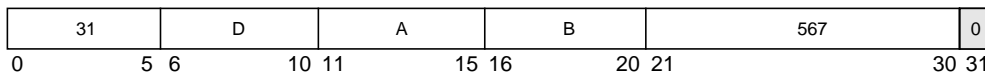

```
EA ← (rA) + (rB)
frD ← DOUBLE(MEM(EA, 4))
rA ← EA
```

EA is the sum **(rA) + (rB)**.

The word in memory addressed by EA is interpreted as a floating-point single-precision operand. This word is converted to floating-point double-precision (see Section D.6, “Floating-Point Load Instructions”) and placed into **frD**.

EA is placed into **rA**.

If **rA = 0**, the instruction form is invalid.

Other registers altered:

- None

PowerPC Architecture Level	Supervisor Level	32-Bit	64-Bit	64-Bit Bridge	Optional	Form
----------------------------	------------------	--------	--------	---------------	----------	------

UISA						X
------	--	--	--	--	--	---

lfsx

Load Floating-Point Single Indexed

lfsx **frD,rA,rB**

lfsx

Reserved

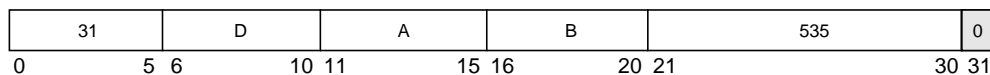

```

if rA = 0 then b ← 0
else      b ← (rA)
EA ← b + (rB)
frD ← DOUBLE(MEM(EA, 4))

```

EA is the sum (rA|0) + (rB).

The word in memory addressed by EA is interpreted as a floating-point single-precision operand. This word is converted to floating-point double-precision (see Section D.6, “Floating-Point Load Instructions”) and placed into frD.

Other registers altered:

- None

PowerPC Architecture Level	Supervisor Level	32-Bit	64-Bit	64-Bit Bridge	Optional	Form
----------------------------	------------------	--------	--------	---------------	----------	------

UISA						X
------	--	--	--	--	--	---

lha

Load Half Word Algebraic

lha

lha **rD,d(rA)**

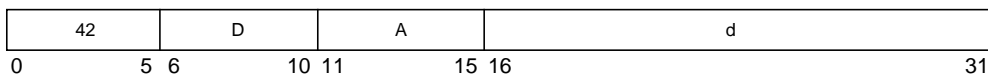

```

if rA = 0 then b ← 0
else      b ← (rA)
EA ← b + EXTS(d)
rD ← EXTS(MEM(EA, 2))

```

EA is the sum $(rA|0) + d$. The half word in memory addressed by EA is loaded into the low-order 16 bits of rD. The remaining bits in rD are filled with a copy of the most-significant bit of the loaded half word.

Other registers altered:

- None

PowerPC Architecture Level Supervisor Level 32-Bit 64-Bit 64-Bit Bridge Optional Form

UISA						D
------	--	--	--	--	--	---

lhau

Load Half Word Algebraic with Update

lhau

lhau **rD,d(rA)**

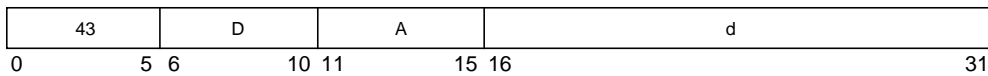

```

EA ← (rA) + EXTS(d)
rD ← EXTS(MEM(EA, 2))
rA ← EA

```

EA is the sum (rA) + d. The half word in memory addressed by EA is loaded into the low-order 16 bits of rD. The remaining bits in rD are filled with a copy of the most-significant bit of the loaded half word.

EA is placed into rA.

If rA = 0 or rA = rD, the instruction form is invalid.

Other registers altered:

- None

PowerPC Architecture Level	Supervisor Level	32-Bit	64-Bit	64-Bit Bridge	Optional	Form
----------------------------	------------------	--------	--------	---------------	----------	------

UISA						D
------	--	--	--	--	--	---

lhaux

Load Half Word Algebraic with Update Indexed

lhaux

lhaux **rD,rA,rB**

Reserved

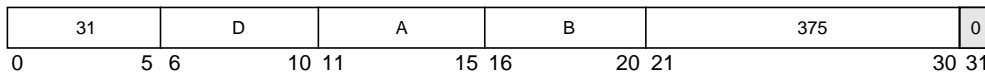

$EA \leftarrow (rA) + (rB)$
 $rD \leftarrow EXTS(MEM(EA, 2))$
 $rA \leftarrow EA$

EA is the sum (rA) + (rB). The half word in memory addressed by EA is loaded into the low-order 16 bits of rD. The remaining bits in rD are filled with a copy of the most-significant bit of the loaded half word.

EA is placed into rA.

If rA = 0 or rA = rD, the instruction form is invalid.

Other registers altered:

- None

PowerPC Architecture Level	Supervisor Level	32-Bit	64-Bit	64-Bit Bridge	Optional	Form
UIA						X

lhax

Load Half Word Algebraic Indexed

lhax **rD,rA,rB**

lhax

Reserved

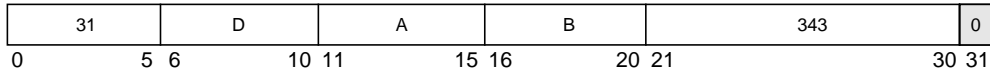

```

if rA = 0 then b ← 0
else      b ← (rA)
EA ← b + (rB)
rD ← EXTS(MEM(EA, 2))

```

EA is the sum $(rA|0) + (rB)$. The half word in memory addressed by EA is loaded into the low-order 16 bits of rD. The remaining bits in rD are filled with a copy of the most-significant bit of the loaded half word.

Other registers altered:

- None

PowerPC Architecture Level	Supervisor Level	32-Bit	64-Bit	64-Bit Bridge	Optional	Form
UISA						X

lhbrx

Load Half Word Byte-Reverse Indexed

lhbrx

lhbrx rD, rA, rB

Reserved

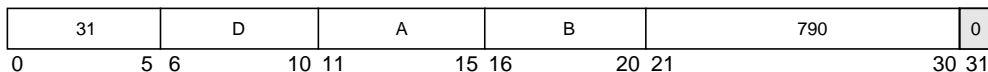

```

if rA = 0 then b ← 0
else      b ← (rA)
EA ← b + (rB)
rD ← (48)0 || MEM(EA + 1, 1) || MEM(EA, 1)
    
```

EA is the sum $(rA|0) + (rB)$. Bits 0–7 of the half word in memory addressed by EA are loaded into the low-order eight bits of rD. Bits 8–15 of the half word in memory addressed by EA are loaded into the subsequent low-order eight bits of rD. The remaining bits in rD are cleared.

The PowerPC architecture cautions programmers that some implementations of the architecture may run the **lhbrx** instructions with greater latency than other types of load instructions.

Other registers altered:

- None

PowerPC Architecture Level	Supervisor Level	32-Bit	64-Bit	64-Bit Bridge	Optional	Form
UISA						X

lhz

Load Half Word and Zero

lhz

lhz $\text{rD}, \text{d}(\text{rA})$

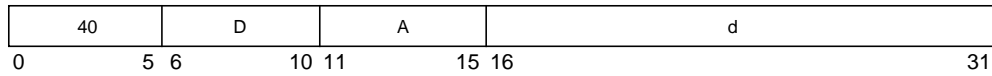

```

if rA = 0 then b ← 0
else    b ← (rA)
EA ← b + EXTS(d)
rD ← (48)0 || MEM(EA, 2)

```

EA is the sum $(\text{rA}|0) + \text{d}$. The half word in memory addressed by EA is loaded into the low-order 16 bits of rD. The remaining bits in rD are cleared.

Other registers altered:

- None

PowerPC Architecture Level	Supervisor Level	32-Bit	64-Bit	64-Bit Bridge	Optional	Form
----------------------------	------------------	--------	--------	---------------	----------	------

UISA						D
------	--	--	--	--	--	---

lhzu

Load Half Word and Zero with Update

lhzu

lhzu **rD,d(rA)**

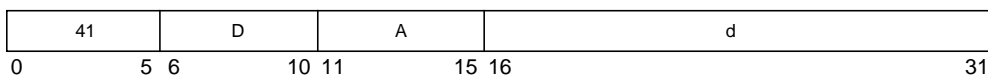

```

EA ← rA + EXTS(d)
rD ← (48)0 || MEM(EA, 2)
rA ← EA

```

EA is the sum (**rA**) + d. The half word in memory addressed by EA is loaded into the low-order 16 bits of **rD**. The remaining bits in **rD** are cleared.

EA is placed into **rA**.

If **rA** = 0 or **rA** = **rD**, the instruction form is invalid.

Other registers altered:

- None

PowerPC Architecture Level	Supervisor Level	32-Bit	64-Bit	64-Bit Bridge	Optional	Form
----------------------------	------------------	--------	--------	---------------	----------	------

UISA						D
------	--	--	--	--	--	---

lhzux

Load Half Word and Zero with Update Indexed

lhzux **rD,rA,rB**

lhzux

Reserved

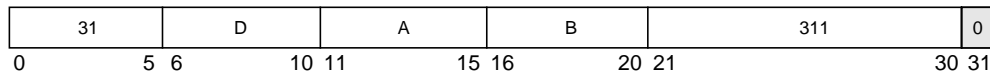

```
EA ← (rA) + (rB)
rD ← (48)0 || MEM(EA, 2)
rA ← EA
```

EA is the sum (rA) + (rB). The half word in memory addressed by EA is loaded into the low-order 16 bits of rD. The remaining bits in rD are cleared.

EA is placed into rA.

If rA = 0 or rA = rD, the instruction form is invalid.

Other registers altered:

- None

PowerPC Architecture Level	Supervisor Level	32-Bit	64-Bit	64-Bit Bridge	Optional	Form
----------------------------	------------------	--------	--------	---------------	----------	------

UISA						X
------	--	--	--	--	--	---

lhzx

Load Half Word and Zero Indexed

lhzx

lhzx **rD,rA,rB**

Reserved

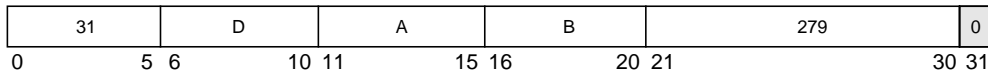

```

if rA = 0 then b ← 0
else b ← (rA)
EA ← b + (rB)
rD ← (48)0 || MEM(EA, 2)

```

EA is the sum (rA|0) + (rB). The half word in memory addressed by EA is loaded into the low-order 16 bits of rD. The remaining bits in rD are cleared.

Other registers altered:

- None

PowerPC Architecture Level	Supervisor Level	32-Bit	64-Bit	64-Bit Bridge	Optional	Form
----------------------------	------------------	--------	--------	---------------	----------	------

UISA						X
------	--	--	--	--	--	---

lswi

Load String Word Immediate

lswi

lswi **rD,rA,NB**

[POWER mnemonic: **lsi**]

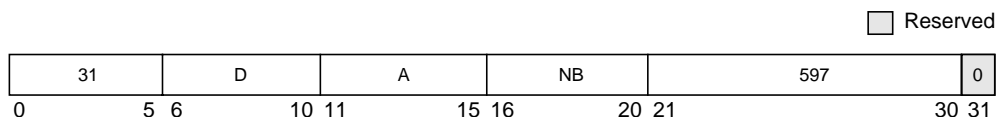

```

if rA = 0 then EA ← 0
else EA ← (rA)
if NB = 0 then n ← 32
else n ← NB
r ← rD - 1
i ← 32
do while n > 0
  if i = 32 then
    r ← r + 1 (mod 32)
    GPR(r) ← 0
  GPR(r)[i-i + 7] ← MEM(EA, 1)
  i ← i + 8
  if i = 64 then i ← 32
  EA ← EA + 1
  n ← n - 1

```

EA is (rA | 0).

Let $n = NB$ if $NB \neq 0$, $n = 32$ if $NB = 0$; n is the number of bytes to load.

Let $nr = \text{CEIL}(n \div 4)$; nr is the number of registers to be loaded with data.

n consecutive bytes starting at EA are loaded into GPRs rD through rD + nr - 1. Data is loaded into the low-order four bytes of each GPR; the high-order four bytes are cleared.

Bytes are loaded left to right in each register. The sequence of registers wraps around to r0 if required. If the low-order 4 bytes of register rD + nr - 1 are only partially filled, the unfilled low-order byte(s) of that register are cleared.

If rA is in the range of registers specified to be loaded, including the case in which rA = 0, the instruction form is invalid.

Under certain conditions (for example, segment boundary crossing) the data alignment exception handler may be invoked. For additional information about data alignment exceptions, see Section 6.4.3, “DSI Exception (0x00300).”

Note that, in some implementations, this instruction is likely to have greater latency and take longer to execute, perhaps much longer, than a sequence of individual load or store instructions that produce the same results.

Other registers altered:

- None

PowerPC Architecture Level	Supervisor Level	32-Bit	64-Bit	64-Bit Bridge	Optional	Form
UIA						X

lswx

Load String Word Indexed

lswx

lswx **rD,rA,rB**

[POWER mnemonic: **lsx**]

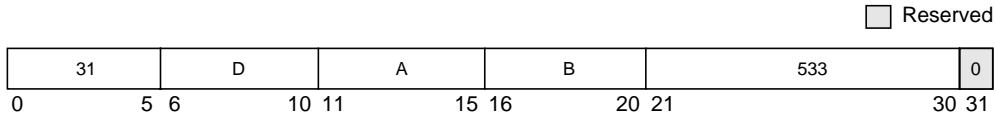

```

if rA = 0 then b ← 0
else    b ← (rA)
EA ← b + (rB)
n ← XER[25–31]
r ← rD - 1
i ← 32
rD ← undefined
do while n > 0
  if i = 32 then
    r ← r + 1 (mod 32)
    GPR(r) ← 0
  GPR(r)[i–i + 7] ← MEM(EA, 1)
  i ← i + 8
  if i = 64 then i ← 32
  EA ← EA + 1
  n ← n - 1

```

EA is the sum $(rA[0] + rB)$. Let $n = XER[25–31]$; n is the number of bytes to load. Let $nr = CEIL(n \div 4)$; nr is the number of registers to receive data. If $n > 0$, n consecutive bytes starting at EA are loaded into GPRs rD through $rD + nr - 1$. Data is loaded into the low-order four bytes of each GPR; the high-order four bytes are cleared.

Bytes are loaded left to right in each register. The sequence of registers wraps around through $r0$ if required. If the low-order four bytes of $rD + nr - 1$ are only partially filled, the unfilled low-order byte(s) of that register are cleared. If $n = 0$, the contents of rD are undefined.

If rA or rB is in the range of registers specified to be loaded, including the case in which $rA = 0$, either the system illegal instruction error handler is invoked or the results are boundedly undefined.

If $rD = rA$ or $rD = rB$, the instruction form is invalid.

If rD and rA both specify GPR0, the form is invalid.

Under certain conditions (for example, segment boundary crossing) the data alignment exception handler may be invoked. For additional information about data alignment exceptions, see Section 6.4.3, “DSI Exception (0x00300).”

Note that, in some implementations, this instruction is likely to have a greater latency and take longer to execute, perhaps much longer, than a sequence of individual load or store instructions that produce the same results.

Other registers altered:

- None

PowerPC Architecture Level	Supervisor Level	32-Bit	64-Bit	64-Bit Bridge	Optional	Form
UIA						X

lwa

64-Bit Implementations Only

lwa

Load Word Algebraic

lwa

rD,ds(rA)

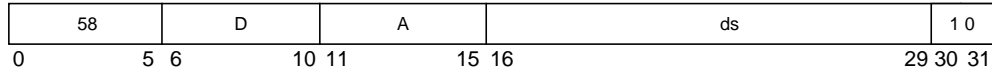

```

if rA = 0 then b ← 0
else    b ← (rA)
EA ← b + EXTS(ds || 0b00)
rD ← EXTS(MEM(EA, 4))

```

EA is the sum (rA|0) + (ds || 0b00). The word in memory addressed by EA is loaded into the low-order 32 bits of rD. The contents of the high-order 32 bits of rD are filled with a copy of bit 0 of the loaded word.

This instruction is defined only for 64-bit implementations. Using it on a 32-bit implementation will cause the system illegal instruction error handler to be invoked.

Other registers altered:

- None

PowerPC Architecture Level	Supervisor Level	32-Bit	64-Bit	64-Bit Bridge	Optional	Form
UISA			√			DS

lwarx

Load Word and Reserve Indexed

lwarx

lwarx **rD,rA,rB**

Reserved

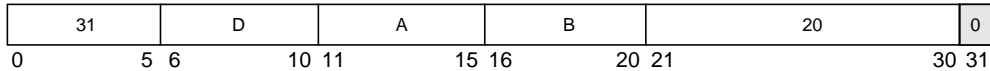

```

if rA = 0 then b ← 0
else    b ← (rA)
EA ← b + (rB)
RESERVE ← 1
RESERVE_ADDR ← physical_addr(EA)
rD ← (32)0 || MEM(EA, 4)

```

EA is the sum (rA[0] + (rB)).

The word in memory addressed by EA is loaded into the low-order 32 bits of rD. The contents of the high-order 32 bits of rD are cleared.

This instruction creates a reservation for use by a store word conditional indexed (**stwcx.**)instruction. The physical address computed from EA is associated with the reservation, and replaces any address previously associated with the reservation.

EA must be a multiple of four. If it is not, either the system alignment exception handler is invoked or the results are boundedly undefined. For additional information about alignment and DSI exceptions, see Section 6.4.3, “DSI Exception (0x00300).”

When the RESERVE bit is set, the processor enables hardware snooping for the block of memory addressed by the RESERVE address. If the processor detects that another processor writes to the block of memory it has reserved, it clears the RESERVE bit. The **stwcx.** instruction will only do a store if the RESERVE bit is set. The **stwcx.** instruction sets the CR0[EQ] bit if the store was successful and clears it if it failed. The **lwarx** and **stwcx.** combination can be used for atomic read-modify-write sequences. Note that the atomic sequence is not guaranteed, but its failure can be detected if CR0[EQ] = 0 after the **stwcx.** instruction.

Other registers altered:

- None

PowerPC Architecture Level	Supervisor Level	32-Bit	64-Bit	64-Bit Bridge	Optional	Form
----------------------------	------------------	--------	--------	---------------	----------	------

UISA						X
------	--	--	--	--	--	---

lwaux

64-Bit Implementations Only

lwaux

Load Word Algebraic with Update Indexed

lwaux **rD,rA,rB**

Reserved

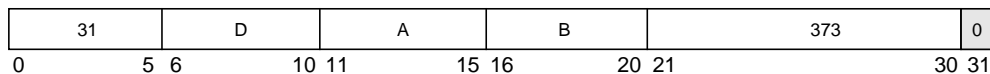

$$EA \leftarrow (rA) + (rB)$$

$$rD \leftarrow \text{EXTS}(\text{MEM}(EA, 4))$$

$$rA \leftarrow EA$$

EA is the sum $(rA) + (rB)$. The word in memory addressed by EA is loaded into the low-order 32 bits of **rD**. The high-order 32 bits of **rD** are filled with a copy of bit 0 of the loaded word.

EA is placed into **rA**.

If $rA = 0$ or $rA = rD$, the instruction form is invalid.

This instruction is defined only for 64-bit implementations. Using it on a 32-bit implementation will cause the system illegal instruction error handler to be invoked.

Other registers altered:

- None

PowerPC Architecture Level	Supervisor Level	32-Bit	64-Bit	64-Bit Bridge	Optional	Form
----------------------------	------------------	--------	--------	---------------	----------	------

UISA			√			X
------	--	--	---	--	--	---

lwx

64-Bit Implementations Only

lwx

Load Word Algebraic Indexed

lwx **rD,rA,rB**

Reserved

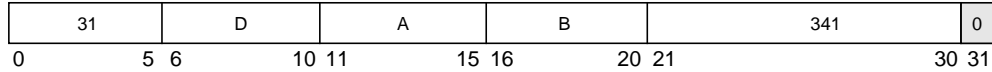

```

if rA = 0 then b ← 0
else    b ← (rA)
EA ← b + (rB)
rD ← EXTS(MEM(EA, 4))

```

EA is the sum $(rA|0) + (rB)$. The word in memory addressed by EA is loaded into the low-order 32 bits of rD. The high-order 32 bits of rD are filled with a copy of bit 0 of the loaded word.

This instruction is defined only for 64-bit implementations. Using it on a 32-bit implementation will cause the system illegal instruction error handler to be invoked.

Other registers altered:

- None

PowerPC Architecture Level	Supervisor Level	32-Bit	64-Bit	64-Bit Bridge	Optional	Form
UIA			√			X

lwbrx

Load Word Byte-Reverse Indexed

lwbrx **rD,rA,rB**

[POWER mnemonic: **lbrx**]

lwbrx

Reserved

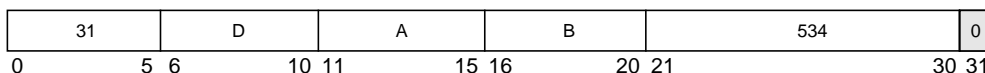

```

if rA = 0 then b ← 0
else    b ← (rA)
EA ← b + (rB)
rD ← (32)0 || MEM(EA + 3, 1) || MEM(EA + 2, 1) || MEM(EA + 1, 1) || MEM(EA, 1)

```

EA is the sum (rA|0) + rB. Bits 0–7 of the word in memory addressed by EA are loaded into the low-order 8 bits of rD. Bits 8–15 of the word in memory addressed by EA are loaded into the subsequent low-order 8 bits of rD. Bits 16–23 of the word in memory addressed by EA are loaded into the subsequent low-order eight bits of rD. Bits 24–31 of the word in memory addressed by EA are loaded into the subsequent low-order 8 bits of rD. The high-order 32 bits of rD are cleared.

The PowerPC architecture cautions programmers that some implementations of the architecture may run the **lwbrx** instructions with greater latency than other types of load instructions.

Other registers altered:

- None

PowerPC Architecture Level	Supervisor Level	32-Bit	64-Bit	64-Bit Bridge	Optional	Form
UIA						X

lwz

Load Word and Zero

lwz

lwz **rD,d(rA)**

[POWER mnemonic: I]

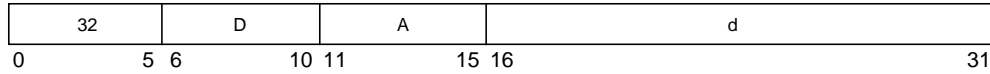

```

if rA = 0 then b ← 0
else    b ← (rA)
EA ← b + EXTS(d)
rD ← (32)0 || MEM(EA, 4)

```

EA is the sum (rA|0) + d. The word in memory addressed by EA is loaded into the low-order 32 bits of rD. The high-order 32 bits of rD are cleared.

Other registers altered:

- None

PowerPC Architecture Level	Supervisor Level	32-Bit	64-Bit	64-Bit Bridge	Optional	Form
UI5A						D

lwzu

Load Word and Zero with Update

lwzu

lwzu $rD, d(rA)$

[POWER mnemonic: **lu**]

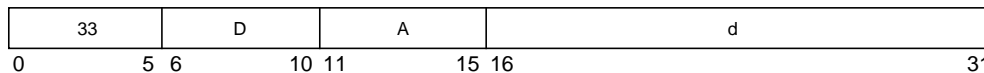

$EA \leftarrow rA + EXTS(d)$
 $rD \leftarrow (32)0 \ || \ MEM(EA, 4)$
 $rA \leftarrow EA$

EA is the sum (rA) + d . The word in memory addressed by EA is loaded into the low-order 32 bits of rD . The high-order 32 bits of rD are cleared.

EA is placed into rA .

If $rA = 0$, or $rA = rD$, the instruction form is invalid.

Other registers altered:

- None

PowerPC Architecture Level	Supervisor Level	32-Bit	64-Bit	64-Bit Bridge	Optional	Form
----------------------------	------------------	--------	--------	---------------	----------	------

UISA						D
------	--	--	--	--	--	---

lwzux

Load Word and Zero with Update Indexed

lwzux

lwzux **rD,rA,rB**

[POWER mnemonic: **lux**]

Reserved

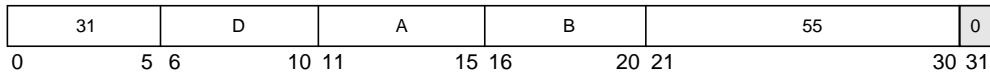

$$EA \leftarrow (rA) + (rB)$$

$$rD \leftarrow (32)0 \ || \ MEM(EA, 4)$$

$$rA \leftarrow EA$$

EA is the sum (rA) + (rB). The word in memory addressed by EA is loaded into the low-order 32 bits of rD. The high-order 32 bits of rD are cleared.

EA is placed into rA.

If rA = 0, or rA = rD, the instruction form is invalid.

Other registers altered:

- None

PowerPC Architecture Level	Supervisor Level	32-Bit	64-Bit	64-Bit Bridge	Optional	Form
----------------------------	------------------	--------	--------	---------------	----------	------

UISA						X
------	--	--	--	--	--	---

lwzx

Load Word and Zero Indexed

lwzx

lwzx **rD,rA,rB**

[POWER mnemonic: **lx**]

Reserved

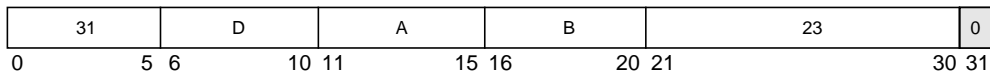

```

if rA = 0 then b ← 0
else    b ← (rA)
EA ← b + rB
rD ← (32)0 || MEM(EA, 4)

```

EA is the sum $(rA|0) + (rB)$. The word in memory addressed by EA is loaded into the low-order 32 bits of rD. The high-order 32 bits of rD are cleared.

Other registers altered:

- None

PowerPC Architecture Level	Supervisor Level	32-Bit	64-Bit	64-Bit Bridge	Optional	Form
----------------------------	------------------	--------	--------	---------------	----------	------

UISA						X
------	--	--	--	--	--	---

mcrf

Move Condition Register Field

mcrf

mcrf **crfD,crfS**

Reserved

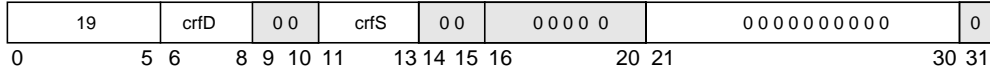

$$CR[4 * crfD - 4 * crfS + 3] \leftarrow CR[4 * crfS - 4 * crfD + 3]$$

The contents of condition register field **crfS** are copied into condition register field **crfD**. All other condition register fields remain unchanged.

Other registers altered:

- Condition Register (CR field specified by operand **crfD**):
Affected: LT, GT, EQ, SO

PowerPC Architecture Level	Supervisor Level	32-Bit	64-Bit	64-Bit Bridge	Optional	Form
UISA						XL

mcrfs

Move to Condition Register from FPSCR

mcrfs

mcrfs

crfD,crfS

Reserved

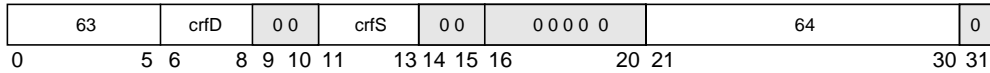

The contents of FPSCR field **crfS** are copied to CR field **crfD**. All exception bits copied (except FEX and VX) are cleared in the FPSCR.

Other registers altered:

- Condition Register (CR field specified by operand **crfD**):
Affected: FX, FEX, VX, OX
- Floating-Point Status and Control Register:
Affected: FX, OX (if **crfS** = 0)
Affected: UX, ZX, XX, VXSNaN (if **crfS** = 1)
Affected: VXISI, VXIDI, VXZDZ, VXIMZ (if **crfS** = 2)
Affected: VXVC (if **crfS** = 3)
Affected: VXSOFT, VXSQRT, VXCVI (if **crfS** = 5)

PowerPC Architecture Level	Supervisor Level	32-Bit	64-Bit	64-Bit Bridge	Optional	Form
UISA						X

mcrxr

Move to Condition Register from XER

mcrxr

mcrxr

crfD

Reserved

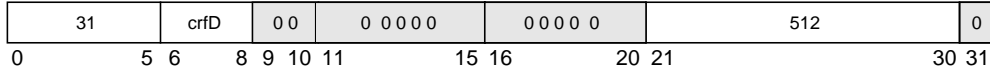

$CR[4 * \mathbf{crfD} - 4 * \mathbf{crfD} + 3] \leftarrow XER[0-3]$
 $XER[0-3] \leftarrow 0b0000$

The contents of XER[0–3] are copied into the condition register field designated by **crfD**. All other fields of the condition register remain unchanged. XER[0–3] is cleared.

Other registers altered:

- Condition Register (CR field specified by operand **crfD**):
Affected: LT, GT, EQ, SO
- XER[0–3]

PowerPC Architecture Level	Supervisor Level	32-Bit	64-Bit	64-Bit Bridge	Optional	Form
UISA						X

mfcrr

Move from Condition Register

mfcrr

mfcrr

rD

Reserved

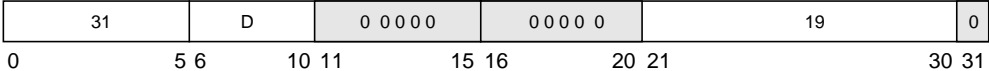

$$rD \leftarrow (32)0 \parallel CR$$

The contents of the condition register (CR) are placed into the low-order 32 bits of rD. The high-order 32 bits of rD are cleared.

Other registers altered:

- None

PowerPC Architecture Level	Supervisor Level	32-Bit	64-Bit	64-Bit Bridge	Optional	Form
UISA						X

mfmsr

Move from Machine State Register

mfmsr

mfmsr

rD

Reserved

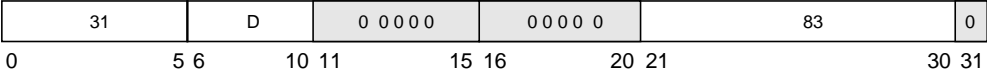

rD ← MSR

The contents of the MSR are placed into rD.

This is a supervisor-level instruction.

Other registers altered:

- None

PowerPC Architecture Level	Supervisor Level	32-Bit	64-Bit	64-Bit Bridge	Optional	Form
OEA	√					X

mf spr

Move from Special-Purpose Register

mf spr

mf spr

rD,SPR

Reserved

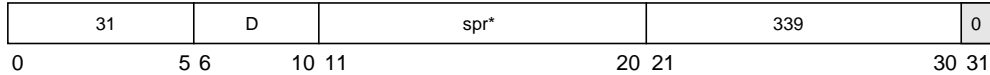

*Note: This is a split field.

```

n ← spr[5-9] || spr[0-4]
if length (SPR(n)) = 64 then
    rD ← SPR(n)
else
    rD ← (32)0 || SPR(n)
    
```

In the PowerPC UISA, the SPR field denotes a special-purpose register, encoded as shown in Table 8-9. The contents of the designated special-purpose register are placed into rD.

For special-purpose registers that are 32 bits long, the low-order 32 bits of rD receive the contents of the special-purpose register and the high-order 32 bits of rD are cleared.

Table 8-9. PowerPC UISA SPR Encodings for mf spr

Decimal	SPR**		Register Name
	spr[5-9]	spr[0-4]	
1	00000	00001	XER
8	00000	01000	LR
9	00000	01001	CTR

** Note that the order of the two 5-bit halves of the SPR number is reversed compared with the actual instruction coding.

If the SPR field contains any value other than one of the values shown in Table 8-9 (and the processor is in user mode), one of the following occurs:

- The system illegal instruction error handler is invoked.
- The system supervisor-level instruction error handler is invoked.
- The results are boundedly undefined.

Other registers altered:

- None

Simplified mnemonics:

mfxr rD	equivalent to	mfspr rD,1
mflr rD	equivalent to	mfspr rD,8
mfctr rD	equivalent to	mfspr rD,9

In the PowerPC OEA, the SPR field denotes a special-purpose register, encoded as shown in Table 8-10. The contents of the designated SPR are placed into rD. For SPRs that are 32 bits long, the low-order 32 bits of rD receive the contents of the SPR and the high-order 32 bits of rD are cleared.

SPR[0] = 1 if and only if reading the register is supervisor-level. Execution of this instruction specifying a defined and supervisor-level register when MSR[PR] = 1 will result in a privileged instruction type program exception.

If MSR[PR] = 1, the only effect of executing an instruction with an SPR number that is not shown in Table 8-10 and has SPR[0] = 1 is to cause a supervisor-level instruction type program exception or an illegal instruction type program exception. For all other cases, MSR[PR] = 0 or SPR[0] = 0. If the SPR field contains any value that is not shown in Table 8-10, either an illegal instruction type program exception occurs or the results are boundedly undefined.

Other registers altered:

- None

Table 8-10. PowerPC OEA SPR Encodings for mfspr

SPR ¹			Register Name	Access
Decimal	spr[5–9]	spr[0–4]		
1	00000	00001	XER	User
8	00000	01000	LR	User
9	00000	01001	CTR	User
18	00000	10010	DSISR	Supervisor
19	00000	10011	DAR	Supervisor
22	00000	10110	DEC	Supervisor
25	00000	11001	SDR1	Supervisor
26	00000	11010	SRR0	Supervisor
27	00000	11011	SRR1	Supervisor
272	01000	10000	SPRG0	Supervisor
273	01000	10001	SPRG1	Supervisor
274	01000	10010	SPRG2	Supervisor
275	01000	10011	SPRG3	Supervisor

Table 8-10. PowerPC OEA SPR Encodings for mfspr (Continued)

Decimal	SPR ¹		Register Name	Access
	spr[5–9]	spr[0–4]		
280	01000	11000	ASR ²	Supervisor
282	01000	11010	EAR	Supervisor
287	01000	11111	PVR	Supervisor
528	10000	10000	IBAT0U	Supervisor
529	10000	10001	IBAT0L	Supervisor
530	10000	10010	IBAT1U	Supervisor
531	10000	10011	IBAT1L	Supervisor
532	10000	10100	IBAT2U	Supervisor
533	10000	10101	IBAT2L	Supervisor
534	10000	10110	IBAT3U	Supervisor
535	10000	10111	IBAT3L	Supervisor
536	10000	11000	DBAT0U	Supervisor
537	10000	11001	DBAT0L	Supervisor
538	10000	11010	DBAT1U	Supervisor
539	10000	11011	DBAT1L	Supervisor
540	10000	11100	DBAT2U	Supervisor
541	10000	11101	DBAT2L	Supervisor
542	10000	11110	DBAT3U	Supervisor
543	10000	11111	DBAT3L	Supervisor
1013	11111	10101	DABR	Supervisor

¹Note that the order of the two 5-bit halves of the SPR number is reversed compared with actual instruction coding.

For **mtspr** and **mfspr** instructions, the SPR number coded in assembly language does not appear directly as a 10-bit binary number in the instruction. The number coded is split into two 5-bit halves that are reversed in the instruction, with the high-order five bits appearing in bits 16–20 of the instruction and the low-order five bits in bits 11–15.

²64-bit implementations only.

PowerPC Architecture Level	Supervisor Level	32-Bit	64-Bit	64-Bit Bridge	Optional	Form
UIA/OEA	√*					AFX

* Note that **mfspr** is supervisor-level only if SPR[0] = 1.

mfsr

Move from Segment Register

mfsr

mfsr

rD,SR

Reserved

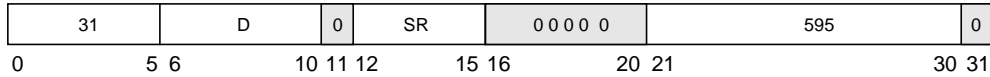

$$rD \leftarrow \text{SEGREG}(SR)$$

The contents of segment register SR are placed into rD.

This is a supervisor-level instruction.

This instruction is defined only for 32-bit implementations; using it on a 64-bit implementation causes an illegal instruction type program exception.

Other registers altered:

- None

TEMPORARY 64-BIT BRIDGE

$$rD \leftarrow \text{SLB}(SR)$$

The contents of the SLB entry selected by SR are placed into rD; the contents of rD correspond to a segment table entry containing values as shown in Table 8-19.

Table 8-11. GPR Content Format Following mfsr

SLB Double Word	Bit(s)	Contents	Description
0	0–31	0x0000_0000	ESID[0–31]
	32–35	SR	ESID[32–35]
	57–59	rD[32–34]	T, Ks, Kp
	60–61	rD[35–36]	N, reserved bit, or b0
1	0–24	rD[7–31]	VSID[0–24] or reserved
	25–51	rD[37–63]	VSID[25–51], or b1, CNTLR_SPEC
None	—	rD[0–6]	0b0000_000

If the SLB entry selected by SR was not created by an **mtsr**, **mtsr**d, or **mtsr**din instruction, the contents of rD are undefined.

This is a supervisor-level instruction.

Other registers altered:

- None

PowerPC Architecture Level	Supervisor Level	32-Bit	64-Bit	64-Bit Bridge	Optional	Form
OEA	√	√		√		X

mfsrin

Move from Segment Register Indirect

mfsrin

mfsrin **rD,rB**

Reserved

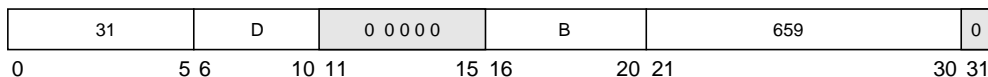

$$rD \leftarrow \text{SEGREG}(rB[0-3])$$

The contents of the segment register selected by bits 0–3 of **rB** are copied into **rD**.

This is a supervisor-level instruction.

This instruction is defined only for 32-bit implementations. Using it on a 64-bit implementation causes an illegal instruction type program exception.

Note that the **rA** field is not defined for the **mfsrin** instruction in the PowerPC architecture. However, **mfsrin** performs the same function in the PowerPC architecture as does the **mfsri** instruction in the POWER architecture (if **rA** = 0).

Other registers altered:

- None

TEMPORARY 64-BIT BRIDGE

$$rD \leftarrow \text{SLB}(rB[32-35])$$

The contents of the SLB entry selected by **rB[32–35]** are placed into **rD**; the contents of **rD** correspond to a segment table entry containing values as shown in Table 8-19:

Table 8-12. GPR Content Format Following mfsrin

Doubleword	Bit(s)	Contents	Description
0	0-31	0x0000_0000	ESID[0–31]
	32-35	rB[32–35]	ESID[32–35]
	57-59	rD[32–34]	T, Ks, Kp
	60-61	rD[35–36]	N, reserved bit, or b0
1	0-24	rD[7–31]	VSID[0–24] or reserved
	25-51	rD[37–63]	VSID[25–51], or b1, CNTLR_SPEC
none	⁷ 0	rD[0–6]	0b0000_000

If the SLB entry selected by rB[32–35] was not created by an **mtsr**, **mtsr**d, or **mtsr**din instruction, the contents of rD are undefined.

This is a supervisor-level instruction.

Other registers altered:

- None

PowerPC Architecture Level	Supervisor Level	32-Bit	64-Bit	64-Bit Bridge	Optional	Form
OEA	√	√		√		X

mftb

Move from Time Base

mftb

mftb

rD, TBR

Reserved

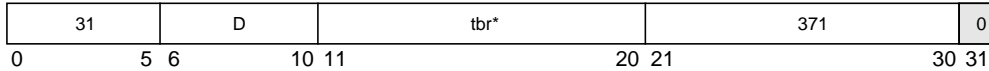

*Note: This is a split field.

```

n ← tbr[5-9] || tbr[0-4]
if n = 268 then
  if (64-bit implementation) then
    rD ← TB
  else
    rD ← TBL
else if n = 269 then
  if (64-bit implementation) then
    rD ← (32)0 || TBU
  else
    rD ← TBU

```

When reading the time base lower (TBL) on a 64-bit implementation, the contents of the entire time base (TBU || TBL) is copied into rD. Note that when reading time base upper (TBU) on a 64-bit implementation the high-order 32 bits of rD are cleared. The TBR field denotes either the TBL or TBU, encoded as shown in Table 8-13.

Table 8-13. TBR Encodings for mftb

TBR*			Register Name	Access
Decimal	tbr[5-9]	tbr[0-4]		
268	01000	01100	TBL	User
269	01000	01101	TBU	User

*Note that the order of the two 5-bit halves of the TBR number is reversed.

If the TBR field contains any value other than one of the values shown in Table 8-13, then one of the following occurs:

- The system illegal instruction error handler is invoked.
- The system supervisor-level instruction error handler is invoked.
- The results are boundedly undefined.

It is important to note that some implementations may implement **mftb** and **mfspr** identically, therefore, a TBR number must not match an SPR number.

For more information on the time base refer to Section 2.2, “PowerPC VEA Register Set—Time Base.”

Other registers altered:

- None

Simplified mnemonics:

mftb rD	equivalent to	mftb rD,268
mftbu rD	equivalent to	mftb rD,269

PowerPC Architecture Level	Supervisor Level	32-Bit	64-Bit	64-Bit Bridge	Optional	Form
VEA						XFx

mtrcf

Move to Condition Register Fields

mtrcf

mtrcf CRM,rS

Reserved

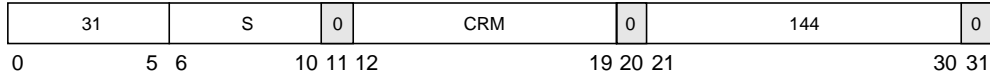

$$\text{mask} \leftarrow (4)(\text{CRM}[0]) \mid (4)(\text{CRM}[1]) \mid \dots \mid (4)(\text{CRM}[7])$$

$$\text{CR} \leftarrow (\text{rS}[32-63] \& \text{mask}) \mid (\text{CR} \& \neg \text{mask})$$

The contents of the low-order 32 bits of **rS** are placed into the condition register under control of the field mask specified by **CRM**. The field mask identifies the 4-bit fields affected. Let *i* be an integer in the range 0–7. If **CRM**(*i*) = 1, **CR** field *i* (**CR** bits 4 * *i* through 4 * *i* + 3) is set to the contents of the corresponding field of the low-order 32 bits of **rS**.

Note that updating a subset of the eight fields of the condition register may have substantially poorer performance on some implementations than updating all of the fields.

Other registers altered:

- **CR** fields selected by mask

Simplified mnemonics:

mtrc rS equivalent to **mtrcf** 0xFF,rS

PowerPC Architecture Level Supervisor Level 32-Bit 64-Bit 64-Bit Bridge Optional Form

UISA						XFX
------	--	--	--	--	--	-----

mtfsb0_X

Move to FPSCR Bit 0

mtfsb0_X

mtfsb0 **crbD** (Rc = 0)

mtfsb0. **crbD** (Rc = 1)

Reserved

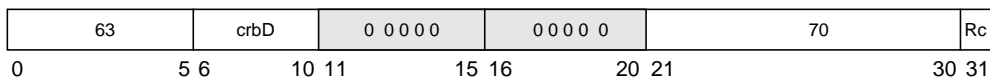

Bit **crbD** of the FPSCR is cleared.

Other registers altered:

- Condition Register (CR1 field):
Affected: FX, FEX, VX, OX (if Rc = 1)
- Floating-Point Status and Control Register:
Affected: FPSCR bit **crbD**
Note: Bits 1 and 2 (FEX and VX) cannot be explicitly cleared.

PowerPC Architecture Level	Supervisor Level	32-Bit	64-Bit	64-Bit Bridge	Optional	Form
UISA						X

mtfsb1_X

Move to FPSCR Bit 1

mtfsb1_X

mtfsb1 **crbD** (Rc = 0)

mtfsb1. **crbD** (Rc = 1)

Reserved

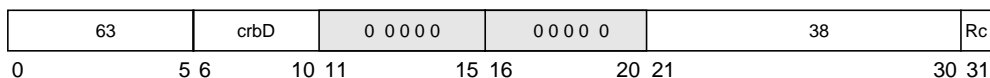

Bit **crbD** of the FPSCR is set.

Other registers altered:

- Condition Register (CR1 field):
Affected: FX, FEX, VX, OX (if Rc = 1)
- Floating-Point Status and Control Register:
Affected: FPSCR bit **crbD** and FX
Note: Bits 1 and 2 (FEX and VX) cannot be explicitly set.

PowerPC Architecture Level	Supervisor Level	32-Bit	64-Bit	64-Bit Bridge	Optional	Form
UISA						X

mtfsf_x

Move to FPSCR Fields

mtfsf_x

mtfsf FM,frB (Rc = 0)

mtfsf. FM,frB (Rc = 1)

Reserved

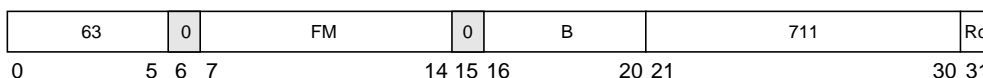

The low-order 32 bits of **frB** are placed into the FPSCR under control of the field mask specified by FM. The field mask identifies the 4-bit fields affected. Let *i* be an integer in the range 0–7. If FM[*i*] = 1, FPSCR field *i* (FPSCR bits 4 * *i* through 4 * *i* + 3) is set to the contents of the corresponding field of the low-order 32 bits of register **frB**.

FPSCR[FX] is altered only if FM[0] = 1.

Updating fewer than all eight fields of the FPSCR may have substantially poorer performance on some implementations than updating all the fields.

When FPSCR[0–3] is specified, bits 0 (FX) and 3 (OX) are set to the values of **frB**[32] and **frB**[35] (that is, even if this instruction causes OX to change from 0 to 1, FX is set from **frB**[32] and not by the usual rule that FX is set when an exception bit changes from 0 to 1). Bits 1 and 2 (FEX and VX) are set according to the usual rule and not from **frB**[33–34].

Other registers altered:

- Condition Register (CR1 field):
Affected: FX, FEX, VX, OX (if Rc = 1)
- Floating-Point Status and Control Register:
Affected: FPSCR fields selected by mask

PowerPC Architecture Level	Supervisor Level	32-Bit	64-Bit	64-Bit Bridge	Optional	Form
UISA						XFL

mtfsfi_x

Move to FPSCR Field Immediate

mtfsfi_x

mtfsfi **crfD,IMM** (Rc = 0)

mtfsfi. **crfD,IMM** (Rc = 1)

Reserved

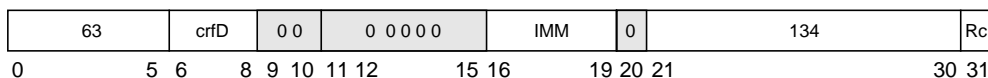

FPSCR[**crfD**] ← IMM

The value of the IMM field is placed into FPSCR field **crfD**.

FPSCR[FX] is altered only if **crfD** = 0.

When FPSCR[0–3] is specified, bits 0 (FX) and 3 (OX) are set to the values of IMM[0] and IMM[3] (that is, even if this instruction causes OX to change from 0 to 1, FX is set from IMM[0] and not by the usual rule that FX is set when an exception bit changes from 0 to 1). Bits 1 and 2 (FEX and VX) are set according to the usual rule and not from IMM[1–2].

Other registers altered:

- Condition Register (CR1 field):
Affected: FX, FEX, VX, OX (if Rc = 1)
- Floating-Point Status and Control Register:
Affected: FPSCR field **crfD**

PowerPC Architecture Level	Supervisor Level	32-Bit	64-Bit	64-Bit Bridge	Optional	Form
----------------------------	------------------	--------	--------	---------------	----------	------

UISA						X
------	--	--	--	--	--	---

mtmsr

Move to Machine State Register

mtmsr

mtmsr

rS

Reserved

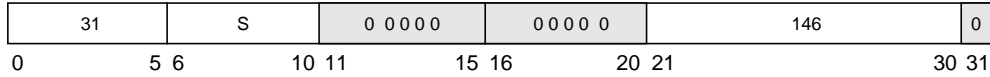

$$MSR \leftarrow (rS)$$

The contents of **rS** are placed into the MSR.

This is a supervisor-level instruction. It is also an execution synchronizing instruction except with respect to alterations to the POW and LE bits. Refer to Section 2.3.18, “Synchronization Requirements for Special Registers and for Lookaside Buffers,” for more information.

In addition, alterations to the MSR[EE] and MSR[RI] bits are effective as soon as the instruction completes. Thus if MSR[EE] = 0 and an external or decremter exception is pending, executing an **mtmsr** instruction that sets MSR[EE] = 1 will cause the external or decremter exception to be taken before the next instruction is executed, if no higher priority exception exists.

This instruction is defined only for 32-bit implementations. Using it on a 64-bit implementation causes an illegal instruction type program exception.

Other registers altered:

- MSR

TEMPORARY 64-BIT BRIDGE

The **mtmsr** instruction may optionally be provided by a 64-bit implementation. The operation of the **mtmsr** instruction in a 64-bit implementation is identical to operation in a 32-bit implementation, except as described below:

- Bits 32–63 of **rS** are placed into the corresponding bits of the MSR. The high-order 32 bits of the MSR are unchanged.

Note that there is no need for an optional version of the **mfmsr** instruction, as the existing instruction copies the entire contents of the MSR to the selected GPR.

When the optional **mtmsr** instruction is provided in a 64-bit implementation, the optional **rfi** instruction is also provided. Refer to the **rfi** instruction description for additional detail about the operation of the **rfi** instruction in 64-bit implementations.

PowerPC Architecture Level	Supervisor Level	32-Bit	64-Bit	64-Bit Bridge	Optional	Form
OEA	√	√		√		X

mtmsrd

64-Bit Implementations Only

mtmsrd

Move to Machine State Register Double Word

mtmsrd

rS

Reserved

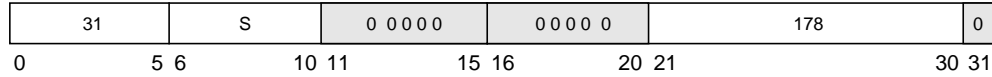

MSR ← (rS)

The contents of rS are placed into the MSR.

This is a supervisor-level instruction. It is also an execution synchronizing instruction except with respect to alterations to the POW and LE bits. Refer to Section 2.3.18, “Synchronization Requirements for Special Registers and for Lookaside Buffers,” for more information.

In addition, alterations to the MSR[EE] and MSR[RI] bits are effective as soon as the instruction completes. Thus if MSR[EE] = 0 and an external or decremter exception is pending, executing an mtmsrd instruction that sets MSR[EE] = 1 will cause the external or decremter exception to be taken before the next instruction is executed, if no higher priority exception exists.

This instruction is defined only for 64-bit implementations. Using it on a 32-bit implementation causes an illegal instruction type program exception.

Other registers altered:

- MSR

PowerPC Architecture Level	Supervisor Level	32-Bit	64-Bit	64-Bit Bridge	Optional	Form
OEA	√		√			X

mtspr

Move to Special-Purpose Register

mtspr

mtspr

SPR,rS

Reserved

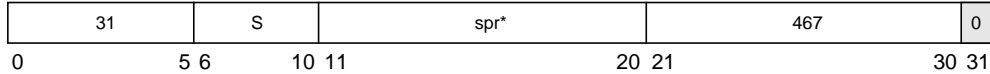

***Note:** This is a split field.

```

n ← spr[5-9] || spr[0-4]
if length (SPR(n)) = 64 then
    SPR(n) ← (rS)
else
    SPR(n) ← rS[32-63]
    
```

In the PowerPC UISA, the SPR field denotes a special-purpose register, encoded as shown in Table 8-14. The contents of rS are placed into the designated special-purpose register. For special-purpose registers that are 32 bits long, the low-order 32 bits of rS are placed into the SPR.

Table 8-14. PowerPC UISA SPR Encodings for mtspr

SPR**			Register Name
Decimal	spr[5-9]	spr[0-4]	
1	00000	00001	XER
8	00000	01000	LR
9	00000	01001	CTR

** Note that the order of the two 5-bit halves of the SPR number is reversed compared with actual instruction coding.

If the SPR field contains any value other than one of the values shown in Table 8-14, and the processor is operating in user mode, one of the following occurs:

- The system illegal instruction error handler is invoked.
- The system supervisor instruction error handler is invoked.
- The results are boundedly undefined.

Other registers altered:

- See Table 8-14.

Simplified mnemonics:

mtxer rD	equivalent to	mtspr 1,rD
mtlr rD	equivalent to	mtspr 8,rD
mtctr rD	equivalent to	mtspr 9,rD

In the PowerPC OEA, the SPR field denotes a special-purpose register, encoded as shown in Table 8-15. The contents of *rS* are placed into the designated special-purpose register. For special-purpose registers that are 32 bits long, the low-order 32 bits of *rS* are placed into the SPR.

For this instruction, SPRs TBL and TBU are treated as separate 32-bit registers; setting one leaves the other unaltered.

The value of SPR[0] = 1 if and only if writing the register is a supervisor-level operation. Execution of this instruction specifying a defined and supervisor-level register when MSR[PR] = 1 results in a privileged instruction type program exception.

If MSR[PR] = 1 then the only effect of executing an instruction with an SPR number that is not shown in Table 8-15 and has SPR[0] = 1 is to cause a privileged instruction type program exception or an illegal instruction type program exception. For all other cases, MSR[PR] = 0 or SPR[0] = 0, if the SPR field contains any value that is not shown in Table 8-15, either an illegal instruction type program exception occurs or the results are boundedly undefined.

Other registers altered:

- See Table 8-15.

Table 8-15. PowerPC OEA SPR Encodings for *mtspr*

Decimal	SPR ¹		Register Name	Access
	spr[5–9]	spr[0–4]		
1	00000	00001	XER	User
8	00000	01000	LR	User
9	00000	01001	CTR	User
18	00000	10010	DSISR	Supervisor
19	00000	10011	DAR	Supervisor
22	00000	10110	DEC	Supervisor
25	00000	11001	SDR1	Supervisor
26	00000	11010	SRR0	Supervisor
27	00000	11011	SRR1	Supervisor
272	01000	10000	SPRG0	Supervisor
273	01000	10001	SPRG1	Supervisor
274	01000	10010	SPRG2	Supervisor
275	01000	10011	SPRG3	Supervisor
280	01000	11000	ASR ²	Supervisor
282	01000	11010	EAR	Supervisor

Table 8-15. PowerPC OEA SPR Encodings for mtspr (Continued)

SPR ¹			Register Name	Access
Decimal	spr[5–9]	spr[0–4]		
284	01000	11100	TBL	Supervisor
285	01000	11101	TBU	Supervisor
528	10000	10000	IBAT0U	Supervisor
529	10000	10001	IBAT0L	Supervisor
530	10000	10010	IBAT1U	Supervisor
531	10000	10011	IBAT1L	Supervisor
532	10000	10100	IBAT2U	Supervisor
533	10000	10101	IBAT2L	Supervisor
534	10000	10110	IBAT3U	Supervisor
535	10000	10111	IBAT3L	Supervisor
536	10000	11000	DBAT0U	Supervisor
537	10000	11001	DBAT0L	Supervisor
538	10000	11010	DBAT1U	Supervisor
539	10000	11011	DBAT1L	Supervisor
540	10000	11100	DBAT2U	Supervisor
541	10000	11101	DBAT2L	Supervisor
542	10000	11110	DBAT3U	Supervisor
543	10000	11111	DBAT3L	Supervisor
1013	11111	10101	DABR	Supervisor

¹Note that the order of the two 5-bit halves of the SPR number is reversed. For **mtspr** and **mfspir** instructions, the SPR number coded in assembly language does not appear directly as a 10-bit binary number in the instruction. The number coded is split into two 5-bit halves that are reversed in the instruction, with the high-order five bits appearing in bits 16–20 of the instruction and the low-order five bits in bits 11–15.

²64-bit implementations only.

PowerPC Architecture Level Supervisor Level 32-Bit 64-Bit 64-Bit Bridge Optional Form

UIA/OEA	√*					AFX
---------	----	--	--	--	--	-----

* Note that **mtspr** is supervisor-level only if SPR[0] = 1.

mtsr

Move to Segment Register

mtsr

mtsr SR,rS

Reserved

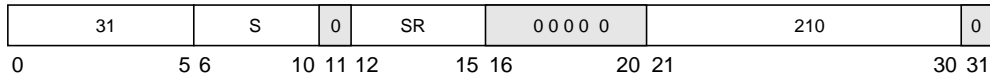

$$\text{SEGREG}(\text{SR}) \leftarrow (\text{rS})$$

The contents of **rS** are placed into **SR**.

This is a supervisor-level instruction.

This instruction is defined only for 32-bit implementations. Using it on a 64-bit implementation causes an illegal instruction type program exception.

Other registers altered:

- None

TEMPORARY 64-BIT BRIDGE

$$\text{SLB}(\text{SR}) \leftarrow (\text{rS}[32-63])$$

The SLB entry selected by **SR** is set as though it were loaded from a segment table entry, as shown in Table 8-19.

Table 8-16. SLB Entry Following mtsr

Double Word	Bit(s)	Contents	Description
0	0–31	0x0000_0000	ESID[0–31]
	32–35	SR	ESID[32–35]
	56	0b1	V
	57–59	rS[32-34]	T, Ks, Kp
	60–61	rS[35-36]	N, reserved bit, or b0
1	0–24	0x0000_00 0b0	VSID[0–24] or reserved
	25–51	rS[37-63]	VSID[25–51], or b1, CNTLR_SPEC

This is a supervisor-level instruction.

Note that when creating an ordinary segment (T = 0) using the **mtsr** instruction, rS[36–39] should be set to 0x0, as these bits correspond to the reserved bits in the T = 0 format for a segment register.

Other registers altered:

- None

PowerPC Architecture Level	Supervisor Level	32-Bit	64-Bit	64-Bit Bridge	Optional	Form
OEA	√	√		√		X

TEMPORARY 64-BIT BRIDGE

mtsrđ

64-Bit Implementations Only

mtsrđ

Move to Segment Register Double Word

mtsrđ

SR,rS

Reserved

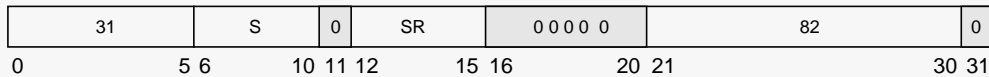

$$SLB(SR) \leftarrow (rS)$$

The contents of rS are placed into the SLB selected by SR. The SLB entry is set as though it were loaded from an STE, as shown in Table 8-19.

Table 8-17. SLB Entry Following mtsrd

Double Word	Bit(s)	Contents	Description
0	0–31	0x0000_0000	ESID[0–31]
	32–35	SR	ESID[32–35]
	56	0b1	V
	57–59	rS[32–34]	T, Ks, Kp
	60–61	rS[35–36]	N, reserved bit, or b0
1	0–24	rS[7–31]	VSID[0–24] or reserved
	25–51	rS[37–63]	VSID[25–51], or b1, CNTRLR_SPEC

This is a supervisor-level instruction.

This instruction is optional, and is defined only for 64-bit implementations. If the **mtsrđ** instruction is implemented, the **mtsrđin** instruction will also be implemented. Using it on a 32-bit implementation causes an illegal instruction type program exception.

Other registers altered:

- None

PowerPC Architecture Level	Supervisor Level	32-Bit	64-Bit	64-Bit Bridge	Optional	Form
OEA	√		√	√	√	X

TEMPORARY 64-BIT BRIDGE

mtsrdin

64-Bit Implementations Only

mtsrdin

Move to Segment Register Double Word Indirect

mtsrdin **rS,rB**

Reserved

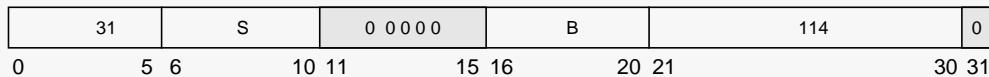

$$SLB(rB[32-35]) \leftarrow (rS)$$

The contents of **rS** are copied to the SLB selected by bits 32–35 of **rB**. The SLB entry is set as though it were loaded from an STE, as shown in Table 8-18.

Table 8-18. SLB Entry following mtsrdin

Double Word	Bit(s)	Contents	Description
0	0–31	0x0000_0000	ESID[0–31]
	32–35	rB[32–35]	ESID[32–35]
	56	0b1	V
	57–59	rS[32–34]	T, Ks, Kp
	60–61	rS[35–36]	N, reserved bit, or b0
1	0–24	rS[7–31]	VSID[0-24] or reserved
	25–51	rS[37–63]	VSID[25–51], or b1, CNTLR_SPEC

This is a supervisor-level instruction.

This instruction is optional, and defined only for 64-bit implementations. If the **mtsrdin** instruction is implemented, the **mtsrdd** instruction will also be implemented. Using it on a 32-bit implementation causes an illegal instruction exception.

Other registers altered:

- None

PowerPC Architecture Level	Supervisor Level	32-Bit	64-Bit	64-Bit Bridge	Optional	Form
OEA	√		√	√	√	X

mtsrin

Move to Segment Register Indirect

mtsrin **rS,rB**

[POWER mnemonic: **mtsri**]

mtsrin

Reserved

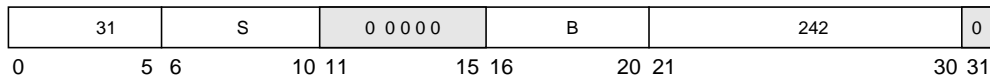

$$\text{SEGREG}(\mathbf{rB}[0-3]) \leftarrow (\mathbf{rS})$$

The contents of **rS** are copied to the segment register selected by bits 0–3 of **rB**.

This is a supervisor-level instruction.

This instruction is defined only for 32-bit implementations. Using it on a 64-bit implementation causes an illegal instruction type program exception.

Note that the PowerPC architecture does not define the **rA** field for the **mtsrin** instruction. However, **mtsrin** performs the same function in the PowerPC architecture as does the **mtsri** instruction in the POWER architecture (if **rA** = 0).

Other registers altered:

- None

TEMPORARY 64-BIT BRIDGE

$SLB(rB[32-35]) \leftarrow (rS[32-63])$

The SLB entry selected by bits 32-35 of **rB** is set as though it were loaded from a segment table entry, as shown in Table 8-19.

Table 8-19. SLB Entry Following mtsrin

Double Word	Bit(s)	Contents	Description
0	0–31	0x0000_0000	ESID[0–31]
	32–35	rB[32–35]	ESID[32–35]
	56	0b1	V
	57–59	rS[32–34]	T, Ks, Kp
	60–61	rS[35–36]	N, reserved bit, or b0
1	0–24	0x0000_00 0b0	VSID[0–24] or reserved
	25–51	rS[37–63]	VSID[25–51], or b1, CNTRLR_SPEC

This is a supervisor-level instruction.

Note that when creating an ordinary segment ($T = 0$) using the **mtsrin** instruction, rS[36–39] should be set to 0x0, as these bits correspond to the reserved bits in the $T = 0$ format for a segment register.

Other registers altered:

- None

PowerPC Architecture Level	Supervisor Level	32-Bit	64-Bit	64-Bit Bridge	Optional	Form
OEA	√	√		√		X

mulhdx

64-Bit Implementations Only

mulhdx

Multiply High Double Word

mulhd **rD,rA,rB** (**Rc = 0**)

mulhd. **rD,rA,rB** (**Rc = 1**)

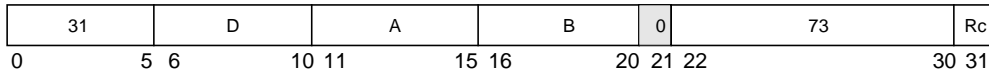

```

prod[0-127] ← (rA) * (rB)
rD ← prod[0-63]

```

The 64-bit operands are (**rA**) and (**rB**). The high-order 64 bits of the 128-bit product of the operands are placed into **rD**.

Both the operands and the product are interpreted as signed integers.

This instruction is defined only for 64-bit implementations. Using it on a 32-bit implementation will cause the system illegal instruction error handler to be invoked.

This instruction may execute faster on some implementations if **rB** contains the operand having the smaller absolute value.

Other registers altered:

- Condition Register (CR0 field):
Affected: LT, GT, EQ, SO (if **Rc = 1**)

Note: The setting of CR0 bits LT, GT, and EQ is mode-dependent, and reflects overflow of the 64-bit result.

PowerPC Architecture Level	Supervisor Level	32-Bit	64-Bit	64-Bit Bridge	Optional	Form
UISA			√			XO

mulhdux 64-Bit Implementations Only mulhdux

Multiply High Double Word Unsigned

mulhdu **rD,rA,rB** (**Rc = 0**)

mulhdu. **rD,rA,rB** (**Rc = 1**)

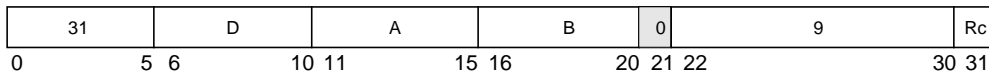

$prod[0-127] \leftarrow (rA) * (rB)$

$rD \leftarrow prod[0-63]$

The 64-bit operands are (**rA**) and (**rB**). The high-order 64 bits of the 128-bit product of the operands are placed into **rD**.

Both the operands and the product are interpreted as unsigned integers, except that if **Rc = 1** the first three bits of **CR0** field are set by signed comparison of the result to zero.

This instruction is defined only for 64-bit implementations. Using it on a 32-bit implementation will cause the system illegal instruction error handler to be invoked.

This instruction may execute faster on some implementations if **rB** contains the operand having the smaller absolute value.

Other registers altered:

- Condition Register (CR0 field):

Affected: LT, GT, EQ, SO (if **Rc = 1**)

Note: The setting of CR0 bits LT, GT, and EQ is mode-dependent, and reflects overflow of the 64-bit result.

PowerPC Architecture Level	Supervisor Level	32-Bit	64-Bit	64-Bit Bridge	Optional	Form
UISA			√			XO

mulhw_X

Multiply High Word

mulhw_X

mulhw **rD,rA,rB** (Rc = 0)

mulhw. **rD,rA,rB** (Rc = 1)

Reserved

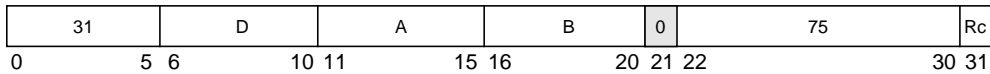

```

prod[0-63] ← rA[32-63] * rB[32-63]
rD[32-63] ← prod[0-31]
rD[0-31] ← undefined

```

The 64-bit product is formed from the contents of the low-order 32 bits of **rA** and **rB**. The high-order 32 bits of the 64-bit product of the operands are placed into the low-order 32 bits of **rD**. The high-order 32 bits of **rD** are undefined.

Both the operands and the product are interpreted as signed integers.

This instruction may execute faster on some implementations if **rB** contains the operand having the smaller absolute value.

Other registers altered:

- Condition Register (CR0 field):
Affected: LT, GT, EQ, SO (if Rc = 1)
LT, GT, EQ undefined (if Rc =1 and 64-bit mode)

Note: The setting of CR0 bits LT, GT, and EQ is mode-dependent, and reflects overflow of the 32-bit result.

PowerPC Architecture Level	Supervisor Level	32-Bit	64-Bit	64-Bit Bridge	Optional	Form
UI5A						XO

mulhwu_x

Multiply High Word Unsigned

mulhwu_x

mulhwu **rD,rA,rB** (**Rc = 0**)

mulhwu. **rD,rA,rB** (**Rc = 1**)

Reserved

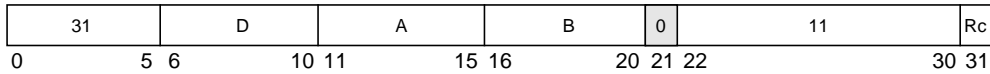

```

prod[0-63] ← rA[32-63] * rB[32-63]
rD[32-63] ← prod[0-31]
rD[0-31] ← undefined

```

The 32-bit operands are the contents of the low-order 32 bits of **rA** and **rB**. The high-order 32 bits of the 64-bit product of the operands are placed into the low-order 32 bits of **rD**. The high-order 32 bits of **rD** are undefined.

Both the operands and the product are interpreted as unsigned integers, except that if **Rc = 1** the first three bits of **CR0** field are set by signed comparison of the result to zero.

This instruction may execute faster on some implementations if **rB** contains the operand having the smaller absolute value.

Other registers altered:

- Condition Register (**CR0** field):
Affected: **LT, GT, EQ, SO** (if **Rc = 1**)
LT, GT, EQ undefined (if **Rc = 1** and 64-bit mode)

Note: The setting of **CR0** bits **LT, GT, and EQ** is mode-dependent, and reflects overflow of the 32-bit result.

PowerPC Architecture Level	Supervisor Level	32-Bit	64-Bit	64-Bit Bridge	Optional	Form
UISA						XO

mulldx

64-Bit Implementations Only

mulldx

Multiply Low Double Word

mulld	rD,rA,rB	(OE = 0 Rc = 0)
mulld.	rD,rA,rB	(OE = 0 Rc = 1)
mulldo	rD,rA,rB	(OE = 1 Rc = 0)
mulldo.	rD,rA,rB	(OE = 1 Rc = 1)

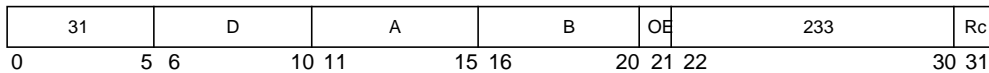

$prod[0-127] \leftarrow (rA) * (rB)$
 $rD \leftarrow prod[64-127]$

The 64-bit operands are the contents of **rA** and **rB**. The low-order 64 bits of the 128-bit product of the operands are placed into **rD**.

Both the operands and the product are interpreted as signed integers. The low-order 64 bits of the product are independent of whether the operands are regarded as signed or unsigned 64-bit integers. If OE = 1, then OV is set if the product cannot be represented in 64 bits.

This instruction is defined only for 64-bit implementations. Using it on a 32-bit implementation will cause the system illegal instruction error handler to be invoked.

This instruction may execute faster on some implementations if **rB** contains the operand having the smaller absolute value.

Other registers altered:

- Condition Register (CR0 field):
 Affected: LT, GT, EQ, SO (if Rc = 1)
Note: CR0 field may not reflect the infinitely precise result if overflow occurs (see XER below).
- XER:
 Affected: SO, OV (if OE = 1)
Note: The setting of the affected bits in the XER is mode-independent, and reflects overflow of the 64-bit result.

PowerPC Architecture Level	Supervisor Level	32-Bit	64-Bit	64-Bit Bridge	Optional	Form
----------------------------	------------------	--------	--------	---------------	----------	------

UISA			√			XO
------	--	--	---	--	--	----

mulli

Multiply Low Immediate

mulli

mulli **rD,rA,SIMM**

[POWER mnemonic: **muli**]

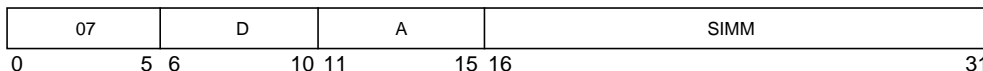

```

prod[0-127] ← (rA) * EXTS(SIMM)
rD ← prod[64-127]

```

The 64-bit first operand is (**rA**). The 64-bit second operand is the sign-extended value of the **SIMM** field. The low-order 64-bits of the 128-bit product of the operands are placed into **rD**.

Both the operands and the product are interpreted as signed integers. The low-order 64 bits (or 32 bits) of the product are calculated independently of whether the operands are treated as signed or unsigned 64-bit (or 32-bit) integers.

This instruction can be used with **mulhdx** or **mulhwx** to calculate a full 128-bit (or 64-bit) product.

The low-order 32 bits of the product are the correct 32-bit product for 32-bit implementations and for 32-bit mode in 64-bit implementations.

Other registers altered:

- None

PowerPC Architecture Level	Supervisor Level	32-Bit	64-Bit	64-Bit Bridge	Optional	Form
UIA						D

mullw_x

Multiply Low Word

mullw_x

mullw **rD,rA,rB** (OE = 0 Rc = 0)
mullw. **rD,rA,rB** (OE = 0 Rc = 1)
mullwo **rD,rA,rB** (OE = 1 Rc = 0)
mullwo. **rD,rA,rB** (OE = 1 Rc = 1)

[POWER mnemonics: **muls**, **muls.**, **mulso**, **mulso.**]

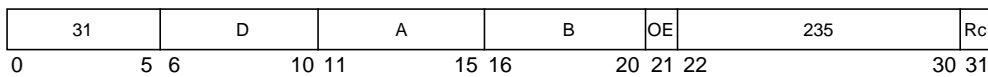

$$rD \leftarrow rA[32-63] * rB[32-63]$$

The 32-bit operands are the contents of the low-order 32 bits of **rA** and **rB**. The low-order 32 bits of the 64-bit product (**rA**) * (**rB**) are placed into **rD**.

The low-order 32 bits of the product are the correct 32-bit product for 32-bit mode of 64-bit implementations and for 32-bit implementations. The low-order 32-bits of the product are independent of whether the operands are regarded as signed or unsigned 32-bit integers.

If OE = 1, then OV is set if the product cannot be represented in 32 bits. Both the operands and the product are interpreted as signed integers.

This instruction can be used with **mulhw_x** to calculate a full 64-bit product.

Note that this instruction may execute faster on some implementations if **rB** contains the operand having the smaller absolute value.

Other registers altered:

- Condition Register (CR0 field):
 Affected: LT, GT, EQ, SO (if Rc = 1)
Note: CR0 field may not reflect the infinitely precise result if overflow occurs (see XER below).
- XER:
 Affected: SO, OV (if OE = 1)
Note: The setting of the affected bits in the XER is mode-independent, and reflects overflow of the low-order 32-bit result.

PowerPC Architecture Level	Supervisor Level	32-Bit	64-Bit	64-Bit Bridge	Optional	Form
UISA						XO

nand_x

NAND

nand_x

nand **rA,rS,rB** (**Rc = 0**)

nand. **rA,rS,rB** (**Rc = 1**)

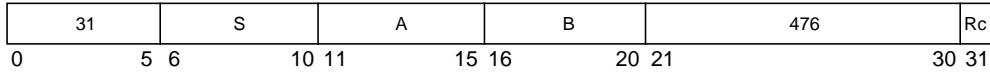

$$rA \leftarrow \neg ((rS) \& (rB))$$

The contents of **rS** are ANDed with the contents of **rB** and the complemented result is placed into **rA**.

nand with **rS = rB** can be used to obtain the one's complement.

Other registers altered:

- Condition Register (CR0 field):
Affected: LT, GT, EQ, SO (if **Rc = 1**)

PowerPC Architecture Level	Supervisor Level	32-Bit	64-Bit	64-Bit Bridge	Optional	Form
UISA						X

neg_x

Negate

neg_x

neg	rD,rA	(OE = 0 Rc = 0)
neg.	rD,rA	(OE = 0 Rc = 1)
nego	rD,rA	(OE = 1 Rc = 0)
nego.	rD,rA	(OE = 1 Rc = 1)

Reserved

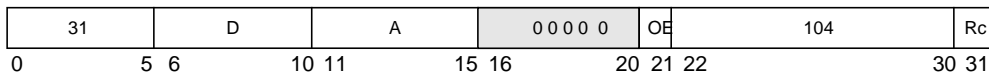

$$rD \leftarrow \neg (rA) + 1$$

The value 1 is added to the complement of the value in **rA**, and the resulting two's complement is placed into **rD**.

If executing in the default 64-bit mode and **rA** contains the most negative 64-bit number (0x8000_0000_0000_0000), the result is the most negative number and, if OE = 1, OV is set. Similarly, if executing in 32-bit mode of a 64-bit implementation (or on a 32-bit implementation) and the low-order 32 bits of **rA** contains the most negative 32-bit number (0x8000_0000), the low-order 32 bits of the result contain the most negative 32-bit number and, if OE = 1, OV is set.

Other registers altered:

- Condition Register (CR0 field):
Affected: LT, GT, EQ, SO (if Rc = 1)
- XER:
Affected: SO OV (if OE = 1)

PowerPC Architecture Level	Supervisor Level	32-Bit	64-Bit	64-Bit Bridge	Optional	Form
UI5A						XO

nor_X

NOR

nor_X

nor **rA,rS,rB** (Rc = 0)
nor. **rA,rS,rB** (Rc = 1)

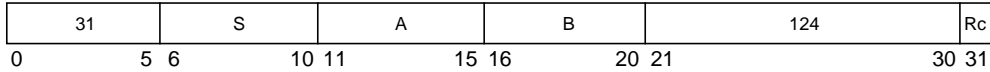

$$rA \leftarrow \neg ((rS) | (rB))$$

The contents of **rS** are ORed with the contents of **rB** and the complemented result is placed into **rA**.

nor with **rS = rB** can be used to obtain the one's complement.

Other registers altered:

- Condition Register (CR0 field):
 Affected: LT, GT, EQ, SO (if Rc = 1)

Simplified mnemonics:

not **rD,rS** equivalent to **nor** **rA,rS,rS**

PowerPC Architecture Level	Supervisor Level	32-Bit	64-Bit	64-Bit Bridge	Optional	Form
----------------------------	------------------	--------	--------	---------------	----------	------

UISA						X
------	--	--	--	--	--	---

or_X

or_X

OR

or **rA,rS,rB** (**Rc** = 0)

or. **rA,rS,rB** (**Rc** = 1)

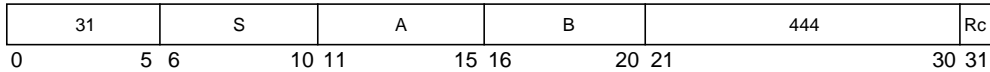

$$rA \leftarrow (rS) | (rB)$$

The contents of **rS** are ORed with the contents of **rB** and the result is placed into **rA**.

The simplified mnemonic **mr** (shown below) demonstrates the use of the **or** instruction to move register contents.

Other registers altered:

- Condition Register (CR0 field):
Affected: LT, GT, EQ, SO (if **Rc** = 1)

Simplified mnemonics:

mr **rA,rS** equivalent to **or** **rA,rS,rS**

PowerPC Architecture Level	Supervisor Level	32-Bit	64-Bit	64-Bit Bridge	Optional	Form
----------------------------	------------------	--------	--------	---------------	----------	------

UISA						X
------	--	--	--	--	--	---

orc_x

OR with Complement

orc_x

orc **rA,rS,rB** (**Rc = 0**)

orc. **rA,rS,rB** (**Rc = 1**)

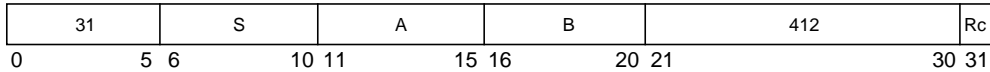

$$rA \leftarrow (rS) \mid \neg (rB)$$

The contents of **rS** are ORed with the complement of the contents of **rB** and the result is placed into **rA**.

Other registers altered:

- Condition Register (CR0 field):
Affected: LT, GT, EQ, SO (if **Rc = 1**)

PowerPC Architecture Level	Supervisor Level	32-Bit	64-Bit	64-Bit Bridge	Optional	Form
UIA						X

ori

OR Immediate

ori

ori **rA,rS,UIMM**

[POWER mnemonic: **oril**]

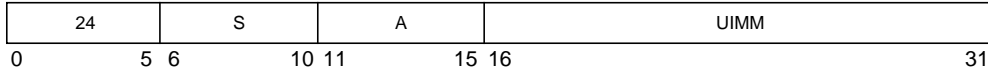

$$rA \leftarrow (rS) \mid ((48)0 \mid \mid UIMM)$$

The contents of **rS** are ORed with 0x0000_0000_0000 || UIMM and the result is placed into **rA**.

The preferred no-op (an instruction that does nothing) is **ori 0,0,0**.

Other registers altered:

- None

Simplified mnemonics:

nop equivalent to **ori 0,0,0**

PowerPC Architecture Level	Supervisor Level	32-Bit	64-Bit	64-Bit Bridge	Optional	Form
----------------------------	------------------	--------	--------	---------------	----------	------

UISA						D
------	--	--	--	--	--	---

oris

OR Immediate Shifted

oris

oris **rA,rS,UIMM**

[POWER mnemonic: **oriu**]

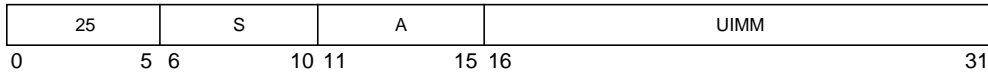

$$rA \leftarrow (rS) \mid ((32)0 \parallel UIMM \parallel (16)0)$$

The contents of **rS** are ORed with 0x0000_0000 || UIMM || 0x0000 and the result is placed into **rA**.

Other registers altered:

- None

PowerPC Architecture Level	Supervisor Level	32-Bit	64-Bit	64-Bit Bridge	Optional	Form
----------------------------	------------------	--------	--------	---------------	----------	------

UISA						D
------	--	--	--	--	--	---

rfi

Return from Interrupt

rfi

Reserved

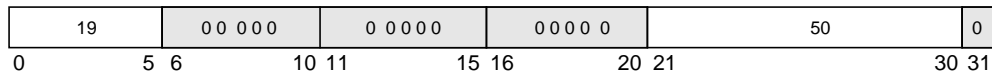

MSR[16–23, 25–27, 30–31] ← SRR1[16–23, 25–27, 30–31]
 NIA ← *iea* SRR0[0–29] || 0b00

Bits SRR1[16–23, 25–27, 30–31] are placed into the corresponding bits of the MSR. If the new MSR value does not enable any pending exceptions, then the next instruction is fetched, under control of the new MSR value, from the address SRR0[0–29] || 0b00. If the new MSR value enables one or more pending exceptions, the exception associated with the highest priority pending exception is generated; in this case the value placed into SRR0 by the exception processing mechanism is the address of the instruction that would have been executed next had the exception not occurred. Note that an implementation may define additional MSR bits, and in this case, may also cause them to be saved to SRR1 from MSR on an exception and restored to MSR from SRR1 on an **rfd** (or **rfi**).

This is a supervisor-level, context synchronizing instruction. This instruction is defined only for 32-bit implementations. Using it on a 64-bit implementation causes an illegal instruction type program exception.

Other registers altered:

- MSR

TEMPORARY 64-BIT BRIDGE

The **rfi** instruction may optionally be provided by a 64-bit implementation. The operation of the **rfi** instruction in a 64-bit implementation is identical to the operation in a 32-bit implementation, except as described below:

- The SRR1 bits that are copied to the corresponding bits of the MSR are bits 48–55, 57–59 and 62–63 of SRR1. Note that depending on the implementation, additional bits from SRR1 may be restored to the MSR. The remaining bits of the MSR, including the high-order bits, are unchanged.
- If the new MSR value does not enable any pending exceptions, then the next instruction is fetched under control of the new MSR value from the address SRR0[0–61] || 0b00 (when SF = 1 in the new MSR value), or from 0x0000_0000 || SRR[32–61] || 0b00 (when SF = 0 in the new MSR value).

When the optional **rfi** instruction is provided in a 64-bit implementation, the optional **mtmsr** instruction is also provided. Refer to the **mtmsr** instruction description for additional detail about the operation of the **mtmsr** instruction in 64-bit implementations.

PowerPC Architecture Level	Supervisor Level	32-Bit	64-Bit	64-Bit Bridge	Optional	Form
OEA	√	√		√		XL

rfid**64-Bit Implementations Only****rfid**

Return from Interrupt Double Word

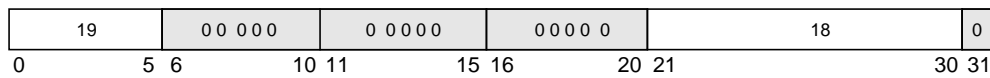
 Reserved

$$\text{MSR}[0, 48-55, 57-59, 62-63] \leftarrow \text{SRR1}[0, 48-55, 57-59, 62-63]$$

$$\text{NIA} \leftarrow_{\text{iea}} \text{SRR0}[0-61] \parallel 0\text{b}00$$

Bits $\text{SRR1}[0, 48-55, 57-59, 62-63]$ are placed into the corresponding bits of the MSR. If the new MSR value does not enable any pending exceptions, then the next instruction is fetched, under control of the new MSR value, from the address $\text{SRR0}[0-61] \parallel 0\text{b}00$ (when $\text{MSR}[\text{SF}] = 1$) or $0\text{x}0000_0000 \parallel \text{SRR0}[32-61] \parallel 0\text{b}00$ (when $\text{MSR}[\text{SF}] = 0$). If the new MSR value enables one or more pending exceptions, the exception associated with the highest priority pending exception is generated; in this case the value placed into SRR0 by the exception processing mechanism is the address of the instruction that would have been executed next had the exception not occurred. Note that an implementation may define additional MSR bits, and in this case, may also cause them to be saved to SRR1 from MSR on an exception and restored to MSR from SRR1 on an **rfid**.

This is a supervisor-level, context synchronizing instruction.

This instruction is defined only for 64-bit implementations. Using it on a 32-bit implementation causes an illegal instruction type program exception.

Other registers altered:

- MSR

PowerPC Architecture Level	Supervisor Level	32-Bit	64-Bit	64-Bit Bridge	Optional	Form
OEA	√		√			XL

rldclx

64-Bit Implementations Only

rldclx

Rotate Left Double Word then Clear Left

rldcl **rA,rS,rB,MB** (**Rc** = 0)

rldcl. **rA,rS,rB,MB** (**Rc** = 1)

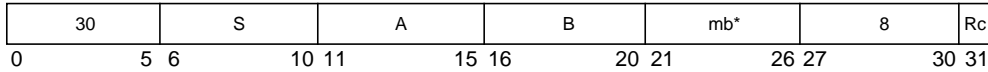

*Note: This is a split field.

```

n ← rB[58-63]
r ← ROTL[64](rS, n)
b ← mb[5] || mb[0-4]
m ← MASK(b, 63)
rA ← r & m

```

The contents of **rS** are rotated left the number of bits specified by operand in the low-order six bits of **rB**. A mask is generated having 1 bits from bit **MB** through bit 63 and 0 bits elsewhere. The rotated data is ANDed with the generated mask and the result is placed into **rA**.

This instruction is defined only for 64-bit implementations. Using it on a 32-bit implementation will cause the system illegal instruction error handler to be invoked.

Note that the **rldcl** instruction can be used to extract and rotate bit fields using the methods shown below:

- To extract an *n*-bit field, that starts at variable bit position *b* in register **rS**, right-justified into **rA** (clearing the remaining 64 - *n* bits of **rA**), set the low-order six bits of **rB** to *b + n* and **MB** = 64 - *n*.
- To rotate the contents of a register left by variable *n* bits, set the low-order six bits of **rB** to *n* and **MB** = 0, and to shift the contents of a register right, set the low-order six bits of **rB** to (64 - *n*), and **MB** = 0.

Other registers altered:

- Condition Register (CR0 field):
Affected: LT, GT, EQ, SO (if **Rc** = 1)

Simplified mnemonics:

rotld rA,rS,rB equivalent to **rldcl rA,rS,rB,0**

PowerPC Architecture Level	Supervisor Level	32-Bit	64-Bit	64-Bit Bridge	Optional	Form
UISA			√			MDS

rldcr_x

64-Bit Implementations Only

rldcr_x

Rotate Left Double Word then Clear Right

rldcr **rA,rS,rB,ME** (**Rc** = 0)

rldcr. **rA,rS,rB,ME** (**Rc** = 1)

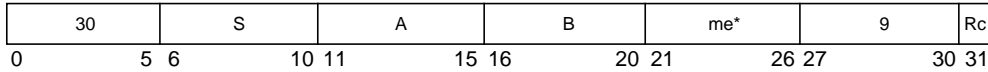

*Note: This is a split field.

```

n ← rB[58-63]
r ← ROTL[64](rS, n)
e ← me[5] || me[0-4]
m ← MASK(0, e)
rA ← r & m

```

The contents of **rS** are rotated left the number of bits specified by the low-order six bits of **rB**. A mask is generated having 1 bits from bit 0 through bit **ME** and 0 bits elsewhere. The rotated data is ANDed with the generated mask and the result is placed into **rA**.

This instruction is defined only for 64-bit implementations. Using it on a 32-bit implementation will cause the system illegal instruction error handler to be invoked.

Note that **rldcr** can be used to extract and rotate bit fields using the methods shown below:

- To extract an *n*-bit field, that starts at variable bit position *b* in register **rS**, left-justified into **rA** (clearing the remaining $64 - n$ bits of **rA**), set the low-order six bits of **rB** to *b* and **ME** = *n* - 1.
- To rotate the contents of a register left by variable *n* bits, set the low-order six bits of **rB** to *n* and **ME** = 63, and to shift the contents of a register right, set the low-order six bits of **rB** to $(64 - n)$, and **ME** = 63.

Other registers altered:

- Condition Register (CR0 field):
Affected: LT, GT, EQ, SO (if **Rc** = 1)

For a detailed list of simplified mnemonics for the **rldcr** instruction, refer to Appendix F, "Simplified Mnemonics."

PowerPC Architecture Level	Supervisor Level	32-Bit	64-Bit	64-Bit Bridge	Optional	Form
UISA			√			MDS

rldicx

64-Bit Implementations Only

rldicx

Rotate Left Double Word Immediate then Clear

rldic **rA,rS,SH,MB** (**Rc = 0**)

rldic. **rA,rS,SH,MB** (**Rc = 1**)

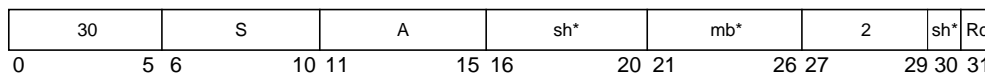

*Note: This is a split field.

```

n ← sh[5] || sh[0-4]
r ← ROTL[64](rS, n)
b ← mb[5] || mb[0-4]
m ← MASK(b, ¬n)
rA ← r & m

```

The contents of **rS** are rotated left the number of bits specified by operand **SH**. A mask is generated having 1 bits from bit **MB** through bit **63 – SH** and 0 bits elsewhere. The rotated data is ANDed with the generated mask and the result is placed into **rA**.

This instruction is defined only for 64-bit implementations. Using it on a 32-bit implementation will cause the system illegal instruction error handler to be invoked.

Note that **rldic** can be used to clear and shift bit fields using the methods shown below:

- To clear the high-order *b* bits of the contents of a register and then shift the result left by *n* bits, set **SH = n** and **MB = b – n**.
- To clear the high-order *n* bits of a register, set **SH = 0** and **MB = n**.

Other registers altered:

- Condition Register (CR0 field):
Affected: LT, GT, EQ, SO (if **Rc = 1**)

Simplified mnemonics:

clrlsldi rA,rS,b,n equivalent to **rldic rA,rS,n,b – n**

For a more detailed list of simplified mnemonics for the **rldic** instruction, refer to Appendix F, “Simplified Mnemonics.”

PowerPC Architecture Level	Supervisor Level	32-Bit	64-Bit	64-Bit Bridge	Optional	Form
UISA			√			MD

rldicl_x

64-Bit Implementations Only

rldicl_x

Rotate Left Double Word Immediate then Clear Left

rldicl **rA,rS,SH,MB** (**Rc** = 0)

rldicl. **rA,rS,SH,MB** (**Rc** = 1)

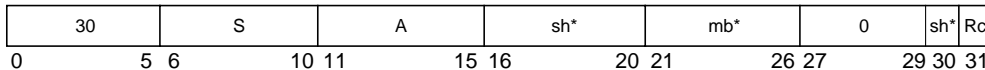

*Note: This is a split field.

```

n ← sh[5] || sh[0-4]
r ← ROTL[64](rS, n)
b ← mb[5] || mb[0-4]
m ← MASK(b, 63)
rA ← r & m

```

The contents of **rS** are rotated left the number of bits specified by operand **SH**. A mask is generated having 1 bits from bit **MB** through bit 63 and 0 bits elsewhere. The rotated data is ANDed with the generated mask and the result is placed into **rA**.

This instruction is defined only for 64-bit implementations. Using it on a 32-bit implementation will cause the system illegal instruction error handler to be invoked.

Note that **rldicl** can be used to extract, rotate, shift, and clear bit fields using the methods shown below:

- To extract an *n*-bit field, that starts at bit position *b* in **rS**, right-justified into **rA** (clearing the remaining 64 - *n* bits of **rA**), set **SH** = *b* + *n* and **MB** = 64 - *n*.
- To rotate the contents of a register left by *n* bits, set **SH** = *n* and **MB** = 0; to rotate the contents of a register right by *n* bits, set **SH** = (64 - *n*), and **MB** = 0.
- To shift the contents of a register right by *n* bits, set **SH** = 64 - *n* and **MB** = *n*.
- To clear the high-order *n* bits of a register, set **SH** = 0 and **MB** = *n*.

Other registers altered:

- Condition Register (CR0 field):
Affected: LT, GT, EQ, SO (if **Rc** = 1)

Simplified mnemonics:

extrdi rA, rS, n, b ($n > 0$)	equivalent to	rldicl $rA, rS, b + n, 64 - n$
rotldi rA, rS, n	equivalent to	rldicl $rA, rS, n, 0$
rotrdi rA, rS, n	equivalent to	rldicl $rA, rS, 64 - n, 0$
srldi rA, rS, n ($n < 64$)	equivalent to	rldicl $rA, rS, 64 - n, n$
clrldi rA, rS, n ($n < 64$)	equivalent to	rldicl $rA, rS, 0, n$

PowerPC Architecture Level	Supervisor Level	32-Bit	64-Bit	64-Bit Bridge	Optional	Form
UIA			√			MD

rldicrx

64-Bit Implementations Only

rldicrx

Rotate Left Double Word Immediate then Clear Right

rldicr **rA,rS,SH,ME** (**Rc = 0**)

rldicr. **rA,rS,SH,ME** (**Rc = 1**)

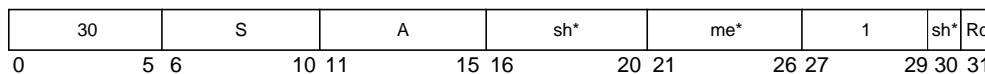

*Note: This is a split field.

```

n ← sh[5] || sh[0-4]
r ← ROTL[64](rS, n)
e ← me[5] || me[0-4]
m ← MASK(0, e)
rA ← r & m

```

The contents of **rS** are rotated left the number of bits specified by operand **SH**. A mask is generated having 1 bits from bit 0 through bit **ME** and 0 bits elsewhere. The rotated data is ANDed with the generated mask and the result is placed into **rA**.

This instruction is defined only for 64-bit implementations. Using it on a 32-bit implementation will cause the system illegal instruction error handler to be invoked.

Note that **rldicr** can be used to extract, rotate, shift, and clear bit fields using the methods shown below:

- To extract an *n*-bit field, that starts at bit position *b* in **rS**, left-justified into **rA** (clearing the remaining $64 - n$ bits of **rA**), set **SH = b** and **ME = n - 1**.
- To rotate the contents of a register left (right) by *n* bits, set **SH = n (64 - n)** and **ME = 63**.
- To shift the contents of a register left by *n* bits, by setting **SH = n** and **ME = 63 - n**.
- To clear the low-order *n* bits of a register, by setting **SH = 0** and **ME = 63 - n**.

Other registers altered:

- Condition Register (CR0 field):
Affected: **LT, GT, EQ, SO** (if **Rc = 1**)

Simplified mnemonics:

extldi rA,rS,n,b	equivalent to	rldicr rA,rS,b,n - 1
sldi rA,rS,n	equivalent to	rldicr rA,rS,n,63 - n
clrrdi rA,rS,n	equivalent to	rldicr rA,rS,0,63 - n

PowerPC Architecture Level	Supervisor Level	32-Bit	64-Bit	64-Bit Bridge	Optional	Form
UISA			√			MD

rldimix

64-Bit Implementations Only

rldimix

Rotate Left Double Word Immediate then Mask Insert

rldimi **rA,rS,SH,MB** (**Rc** = 0)

rldimi. **rA,rS,SH,MB** (**Rc** = 1)

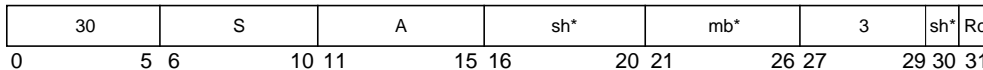

*Note: This is a split field.

```

n ← sh[5] || sh[0-4]
r ← ROTL[64](rS, n)
b ← mb[5] || mb[0-4]
m ← MASK(b, ¬n)
rA ← (r & m) | (rA & ¬m)

```

The contents of **rS** are rotated left the number of bits specified by operand **SH**. A mask is generated having 1 bits from bit **MB** through bit $63 - SH$ and 0 bits elsewhere. The rotated data is inserted into **rA** under control of the generated mask.

This instruction is defined only for 64-bit implementations. Using it on a 32-bit implementation will cause the system illegal instruction error handler to be invoked.

Note that **rldimi** can be used to insert an *n*-bit field, that is right-justified in **rS**, into **rA** starting at bit position *b*, by setting $SH = 64 - (b + n)$ and $MB = b$.

Other registers altered:

- Condition Register (CR0 field):
Affected: LT, GT, EQ, SO (if **Rc** = 1)

Simplified mnemonics:

insrdi rA,rS,n,b equivalent to **rldimi rA,rS,64 - (b + n),b**

For a more detailed list of simplified mnemonics for the **rldimi** instruction, refer to Appendix F, "Simplified Mnemonics."

PowerPC Architecture Level	Supervisor Level	32-Bit	64-Bit	64-Bit Bridge	Optional	Form
UISA			√			MD

rlwimi_x

rlwimi_x

Rotate Left Word Immediate then Mask Insert

rlwimi **rA,rS,SH,MB,ME** (Rc = 0)

rlwimi. **rA,rS,SH,MB,ME** (Rc = 1)

[POWER mnemonics: **rlimi**, **rlimi.**]

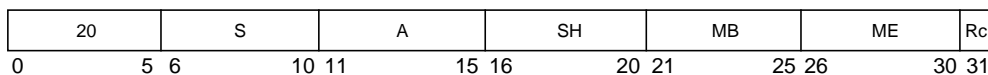

```

n ← SH
r ← ROTL[32](rS[32-63], n)
m ← MASK(MB + 32, ME + 32)
rA ← (r & m) | (rA & ~m)

```

The contents of **rS** are rotated left the number of bits specified by operand **SH**. A mask is generated having 1 bits from bit **MB + 32** through bit **ME + 32** and 0 bits elsewhere. The rotated data is inserted into **rA** under control of the generated mask.

Note that **rlwimi** can be used to insert a bit field into the contents of **rA** using the methods shown below:

- To insert an *n*-bit field, that is left-justified in the low-order 32 bits of **rS**, into the high-order 32 bits of **rA** starting at bit position *b*, set **SH = 32 - b**, **MB = b**, and **ME = (b + n) - 1**.
- To insert an *n*-bit field, that is right-justified in the low-order 32 bits of **rS**, into the high-order 32 bits of **rA** starting at bit position *b*, set **SH = 32 - (b + n)**, **MB = b**, and **ME = (b + n) - 1**.

Other registers altered:

- Condition Register (CR0 field):
Affected: LT, GT, EQ, SO (if Rc = 1)

Simplified mnemonics:

inslwi **rA,rS,n,b** equivalent to **rlwimi** **rA,rS,32 - b,b,b + n - 1**
insrwi **rA,rS,n,b** (*n* > 0) equivalent to **rlwimi** **rA,rS,32 - (b + n),b,(b + n) - 1**

PowerPC Architecture Level	Supervisor Level	32-Bit	64-Bit	64-Bit Bridge	Optional	Form
UISA						M

rlwinm_x

Rotate Left Word Immediate then AND with Mask

rlwinm_x

rlwinm **rA,rS,SH,MB,ME** (**Rc = 0**)

rlwinm. **rA,rS,SH,MB,ME** (**Rc = 1**)

[POWER mnemonics: **rlinm**, **rlinm.**]

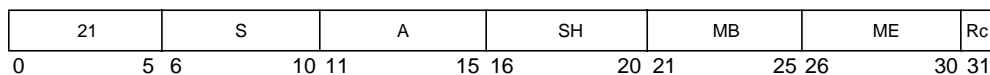

```
n ← SH
r ← ROTL[32](rS[32-63], n)
m ← MASK(MB + 32, ME + 32)
rA ← r & m
```

The contents of **rS**[32-63] are rotated left the number of bits specified by operand **SH**. A mask is generated having 1 bits from bit **MB** + 32 through bit **ME** + 32 and 0 bits elsewhere. The rotated data is ANDed with the generated mask and the result is placed into **rA**. The upper 32 bits of **rA** are cleared.

Note that **rlwinm** can be used to extract, rotate, shift, and clear bit fields using the methods shown below:

- To extract an n -bit field, that starts at bit position b in the high-order 32 bits of **rS**, right-justified into **rA** (clearing the remaining $32 - n$ bits of **rA**), set $SH = b + n$, $MB = 32 - n$, and $ME = 31$.
- To extract an n -bit field, that starts at bit position b in the high-order 32 bits of **rS**, left-justified into **rA** (clearing the remaining $32 - n$ bits of **rA**), set $SH = b$, $MB = 0$, and $ME = n - 1$.
- To rotate the contents of a register left (or right) by n bits, set $SH = n (32 - n)$, $MB = 0$, and $ME = 31$.
- To shift the contents of a register right by n bits, by setting $SH = 32 - n$, $MB = n$, and $ME = 31$. It can be used to clear the high-order b bits of a register and then shift the result left by n bits by setting $SH = n$, $MB = b - n$ and $ME = 31 - n$.
- To clear the low-order n bits of a register, by setting $SH = 0$, $MB = 0$, and $ME = 31 - n$.

For all uses mentioned, the high-order 32 bits of **rA** are cleared.

Other registers altered:

- Condition Register (CR0 field):
Affected: LT, GT, EQ, SO (if **Rc = 1**)

Simplified mnemonics:

extlwi rA, rS, n, b ($n > 0$)	equivalent to	rlwinm $rA, rS, b, 0, n - 1$
extrwi rA, rS, n, b ($n > 0$)	equivalent to	rlwinm $rA, rS, b + n, 32 - n, 31$
rotlwi rA, rS, n	equivalent to	rlwinm $rA, rS, n, 0, 31$
rotrwi rA, rS, n	equivalent to	rlwinm $rA, rS, 32 - n, 0, 31$
slwi rA, rS, n ($n < 32$)	equivalent to	rlwinm $rA, rS, n, 0, 31 - n$
srwi rA, rS, n ($n < 32$)	equivalent to	rlwinm $rA, rS, 32 - n, n, 31$
clrlwi rA, rS, n ($n < 32$)	equivalent to	rlwinm $rA, rS, 0, n, 31$
clrrwi rA, rS, n ($n < 32$)	equivalent to	rlwinm $rA, rS, 0, 0, 31 - n$
clrlslwi rA, rS, b, n ($n \leq b < 32$)	equivalent to	rlwinm $rA, rS, n, b - n, 31 - n$

PowerPC Architecture Level	Supervisor Level	32-Bit	64-Bit	64-Bit Bridge	Optional	Form
UISA						M

rlwnm_x

rlwnm_x

Rotate Left Word then AND with Mask

rlwnm **rA,rS,rB,MB,ME** (**Rc = 0**)

rlwnm. **rA,rS,rB,MB,ME** (**Rc = 1**)

[POWER mnemonics: **rlnm**, **rlnm.**]

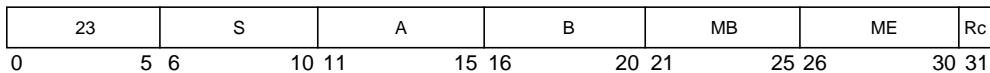

```

n ← rB[59-63]
r ← ROTL[32](rS[32-63], n)
m ← MASK(MB + 32, ME + 32)
rA ← r & m

```

The contents of **rS** are rotated left the number of bits specified by the low-order five bits of **rB**. A mask is generated having 1 bits from bit **MB + 32** through bit **ME + 32** and 0 bits elsewhere. The rotated data is ANDed with the generated mask and the result is placed into **rA**.

Note that **rlwnm** can be used to extract and rotate bit fields using the methods shown as follows:

- To extract an *n*-bit field, that starts at variable bit position *b* in the high-order 32 bits of **rS**, right-justified into **rA** (clearing the remaining $32 - n$ bits of **rA**), by setting the low-order five bits of **rB** to $b + n$, **MB** = $32 - n$, and **ME** = 31.
- To extract an *n*-bit field, that starts at variable bit position *b* in the high-order 32 bits of **rS**, left-justified into **rA** (clearing the remaining $32 - n$ bits of **rA**), by setting the low-order five bits of **rB** to *b*, **MB** = 0, and **ME** = $n - 1$.
- To rotate the contents of a register left (or right) by *n* bits, by setting the low-order five bits of **rB** to n ($32 - n$), **MB** = 0, and **ME** = 31.

For all uses mentioned, the high-order 32 bits of **rA** are cleared.

Other registers altered:

- Condition Register (CR0 field):
Affected: LT, GT, EQ, SO (if **Rc = 1**)

Simplified mnemonics:

rotlw rA,rS,rB equivalent to **rlwnmrA,rS,rB,0,31**

PowerPC Architecture Level	Supervisor Level	32-Bit	64-Bit	64-Bit Bridge	Optional	Form
UISA						M

SC

System Call

SC

[POWER mnemonic: **svca**]

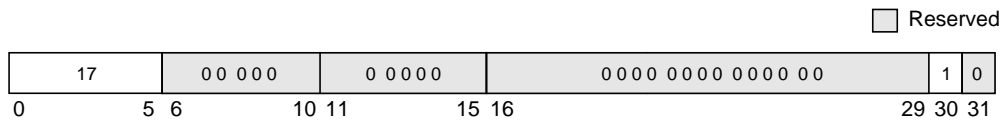

In the PowerPC UISA, the **sc** instruction calls the operating system to perform a service. When control is returned to the program that executed the system call, the content of the registers depends on the register conventions used by the program providing the system service.

This instruction is context synchronizing, as described in Section 4.1.5.1, “Context Synchronizing Instructions.”

Other registers altered:

- Dependent on the system service

In PowerPC OEA, the **sc** instruction does the following:

```

SRR0 ← iea CIA + 4
SRR1[33–36, 42–47] ← 0
SRR1[0, 48–55, 57–59, 62–63] ← MSR[0, 48–55, 57–59, 62–63]
MSR ← new_value (see below)
NIA ← iea base_ea + 0xC00 (see below)

```

The EA of the instruction following the **sc** instruction is placed into SRR0. Bits 0, 48–55, 57–59, and 62–63 of the MSR are placed into the corresponding bits of SRR1, and bits 33–36 and 42–47 of SRR1 are set to undefined values. Note that an implementation may define additional MSR bits, and in this case, may also cause them to be saved to SRR1 from MSR on an exception and restored to MSR from SRR1 on an **rfid** (or **rfi**).

Then a system call exception is generated. The exception causes the MSR to be altered as described in Section 6.4, “Exception Definitions.”

The exception causes the next instruction to be fetched from offset 0xC00 from the physical base address determined by the new setting of MSR[IP].

Other registers altered:

- SRR0
- SRR1
- MSR

PowerPC Architecture Level	Supervisor Level	32-Bit	64-Bit	64-Bit Bridge	Optional	Form
UISA/OEA						SC

slbia

SLB Invalidate All

64-Bit Implementations Only

slbia

Reserved

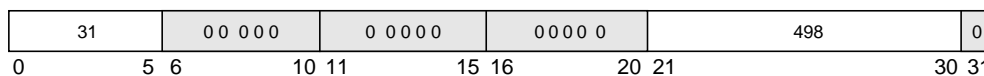

All SLB entries ← invalid

The entire segment lookaside buffer (SLB) is made invalid (that is, all entries are removed).

The SLB is invalidated regardless of the settings of MSR[IR] and MSR[DR].

This instruction is supervisor-level.

This instruction is optional in the PowerPC architecture.

This instruction is defined only for 64-bit implementations. Using it on a 32-bit implementation will cause an illegal instruction type program *exception*.

It is not necessary that the ASR point to a valid segment table when issuing **slbia**.

Other registers altered:

- None

PowerPC Architecture Level	Supervisor Level	32-Bit	64-Bit	64-Bit Bridge	Optional	Form
OEA	√		√		√	X

slbie

64-Bit Implementations Only

slbie

SLB Invalidate Entry

slbie

rB

Reserved

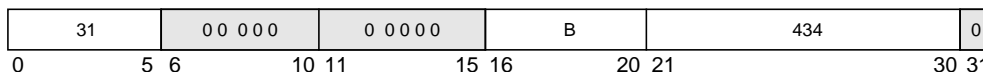

```

EA ← (rB)
if SLB entry exists for EA, then
  SLB entry ← invalid

```

EA is the contents of **rB**. If the segment lookaside buffer (SLB) contains an entry corresponding to EA, that entry is made invalid (that is, removed from the SLB).

The SLB search is done regardless of the settings of MSR[IR] and MSR[DR].

Block address translation for EA, if any, is ignored.

This instruction is supervisor-level and optional in the PowerPC architecture.

This instruction is defined only for 64-bit implementations. Using it on a 32-bit implementation will cause an illegal instruction type program exception.

It is not necessary that the ASR point to a valid segment table when issuing **slbie**.

Note that bits 11–15 of this instruction (ordinarily the position of an **rA** field) must be zero. This provides implementations the option of using (**rA**|0) + **rB** address arithmetic for this instruction.

Other registers altered:

- None

PowerPC Architecture Level	Supervisor Level	32-Bit	64-Bit	64-Bit Bridge	Optional	Form
OEA	√		√		√	X

sld_x

64-Bit Implementations Only

sld_x

Shift Left Double Word

sld **rA,rS,rB** (**Rc = 0**)
sld. **rA,rS,rB** (**Rc = 1**)

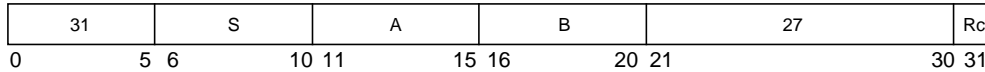

```

n ← rB[58-63]
r ← ROTL[64](rS, n)
if rB[57] = 0 then
    m ← MASK(0, 63 - n)
else m ← (64)0
rA ← r & m

```

The contents of **rS** are shifted left the number of bits specified by the low-order seven bits of **rB**. Bits shifted out of position 0 are lost. Zeros are supplied to the vacated positions on the right. The result is placed into **rA**. Shift amounts from 64 to 127 give a zero result.

This instruction is defined only for 64-bit implementations. Using it on a 32-bit implementation will cause the system illegal instruction error handler to be invoked.

Other registers altered:

- Condition Register (CR0 field):
 Affected: LT, GT, EQ, SO (if **Rc = 1**)

PowerPC Architecture Level	Supervisor Level	32-Bit	64-Bit	64-Bit Bridge	Optional	Form
UISA			√			X

slw_X

Shift Left Word

slw_X

slw **rA,rS,rB** (**Rc = 0**)

slw. **rA,rS,rB** (**Rc = 1**)

[POWER mnemonics: **sl**, **sl.**]

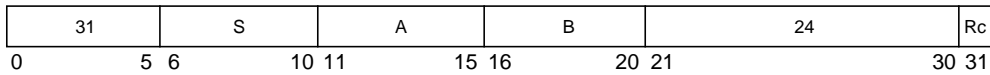

```

n ← rB[59-63]
r ← ROTL[32](rS[32-63], n)
if rB[58] = 0 then
m ← MASK(32, 63 - n)
else m ← (64)0
rA ← r & m

```

The contents of the low-order 32 bits of **rS** are shifted left the number of bits specified by the low-order six bits of **rB**. Bits shifted out of position 32 are lost. Zeros are supplied to the vacated positions on the right. The 32-bit result is placed into the low-order 32 bits of **rA**. The high-order 32 bits of **rA** are cleared. Shift amounts from 32 to 63 give a zero result.

Other registers altered:

- Condition Register (CR0 field):
Affected: LT, GT, EQ, SO (if **Rc = 1**)

PowerPC Architecture Level	Supervisor Level	32-Bit	64-Bit	64-Bit Bridge	Optional	Form
UISA						X

srad_x

64-Bit Implementations Only

srad_x

Shift Right Algebraic Double Word

srad **rA,rS,rB** (**Rc** = 0)
srad. **rA,rS,rB** (**Rc** = 1)

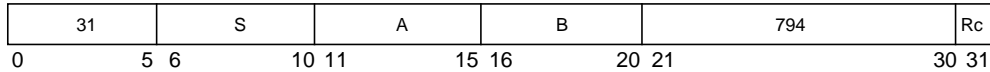

```

n ← rB[58-63]
r ← ROTL[64](rS, 64 - n)
if rB[57] = 0 then
  m ← MASK(n, 63)
else m ← (64)0
S ← rS[0]
rA ← (r & m) | (((64)S) & ¬ m)
XER[CA] ← S & ((r & ¬ m) ≠ 0)

```

The contents of **rS** are shifted right the number of bits specified by the low-order seven bits of **rB**. Bits shifted out of position 63 are lost. Bit 0 of **rS** is replicated to fill the vacated positions on the left. The result is placed into **rA**. **XER[CA]** is set if **rS** is negative and any 1 bits are shifted out of position 63; otherwise **XER[CA]** is cleared. A shift amount of zero causes **rA** to be set equal to **rS**, and **XER[CA]** to be cleared. Shift amounts from 64 to 127 give a result of 64 sign bits in **rA**, and cause **XER[CA]** to receive the sign bit of **rS**.

Note that the **srad** instruction, followed by **addze**, can be used to divide quickly by 2^n . The setting of the CA bit, by **srad**, is independent of mode.

This instruction is defined only for 64-bit implementations. Using it on a 32-bit implementation will cause the system illegal instruction error handler to be invoked.

Other registers altered:

- Condition Register (CR0 field):
Affected: LT, GT, EQ, SO (if **Rc** = 1)
- XER:
Affected: CA

PowerPC Architecture Level	Supervisor Level	32-Bit	64-Bit	64-Bit Bridge	Optional	Form
UISA			√			X

sradi_x

64-Bit Implementations Only

sradi_x

Shift Right Algebraic Double Word Immediate

sradi **rA,rS,SH** (**Rc = 0**)
sradi. **rA,rS,SH** (**Rc = 1**)

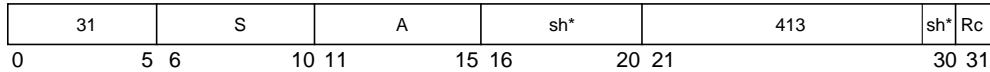

*Note: This is a split field.

```

n ← sh[5] || sh[0-4]
r ← ROTL[64](rS, 64 - n)
m ← MASK(n, 63)
S ← rS[0]
rA ← (r & m) | (((64)S) & ¬ m)
XER[CA] ← S & ((r & ¬ m) ≠ 0)

```

The contents of **rS** are shifted right **SH** bits. Bits shifted out of position 63 are lost. Bit 0 of **rS** is replicated to fill the vacated positions on the left. The result is placed into **rA**. **XER[CA]** is set if **rS** is negative and any 1 bits are shifted out of position 63; otherwise **XER[CA]** is cleared. A shift amount of zero causes **rA** to be set equal to **rS**, and **XER[CA]** to be cleared.

Note that the **sradi** instruction, followed by **addze**, can be used to divide quickly by 2^n . The setting of the **XER[CA]** bit, by **sradi**, is independent of mode.

This instruction is defined only for 64-bit implementations. Using it on a 32-bit implementation will cause the system illegal instruction error handler to be invoked.

Other registers altered:

- Condition Register (CR0 field):
Affected: LT, GT, EQ, SO (if **Rc = 1**)
- XER:
Affected: CA

PowerPC Architecture Level	Supervisor Level	32-Bit	64-Bit	64-Bit Bridge	Optional	Form
UISA			√			XS

sraw_X

Shift Right Algebraic Word

sraw **rA,rS,rB** (**Rc = 0**)
sraw. **rA,rS,rB** (**Rc = 1**)

[POWER mnemonics: **sra**, **sra.**]

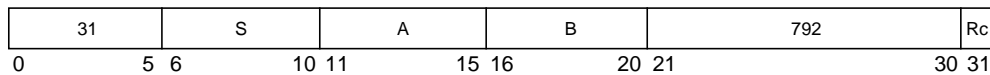

```

n ← rB[59-63]
r ← ROTL[32](rS[32-63], 64 - n)
if rB[58] = 0 then
m ← MASK(n + 32, 63)
else m ← (64)0
S ← rS[32]
rA ← r & m | (64)S & ¬ m
XER[CA] ← S & (r & ¬ m[32-63]) ≠ 0

```

The contents of the low-order 32 bits of **rS** are shifted right the number of bits specified by the low-order six bits of **rB**. Bits shifted out of position 63 are lost. Bit 32 of **rS** is replicated to fill the vacated positions on the left. The 32-bit result is placed into the low-order 32 bits of **rA**. Bit 32 of **rS** is replicated to fill the high-order 32 bits of **rA**. **XER[CA]** is set if the low-order 32 bits of **rS** contain a negative number and any 1 bits are shifted out of position 63; otherwise **XER[CA]** is cleared. A shift amount of zero causes **rA** to receive the sign-extended value of the low-order 32 bits of **rS**, and **XER[CA]** to be cleared. Shift amounts from 32 to 63 give a result of 64 sign bits, and cause **XER[CA]** to receive the sign bit of the low-order 32 bits of **rS**.

Note that the **sraw** instruction, followed by **addze**, can be used to divide quickly by 2^n . The setting of the **XER[CA]** bit, by **sraw**, is independent of mode.

Other registers altered:

- Condition Register (CR0 field):
Affected: LT, GT, EQ, SO (if **Rc = 1**)
- XER:
Affected: CA

PowerPC Architecture Level	Supervisor Level	32-Bit	64-Bit	64-Bit Bridge	Optional	Form
UISA						X

srawi_x

Shift Right Algebraic Word Immediate

srawi_x

srawi **rA,rS,SH** (Rc = 0)
srawi. **rA,rS,SH** (Rc = 1)

[POWER mnemonics: **srai**, **srai.**]

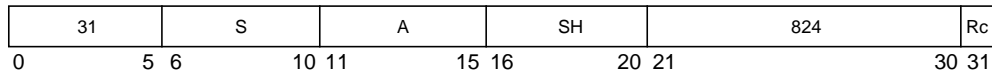

```

n ← SH
r ← ROTL[32](rS[32-63], 64 - n)
m ← MASK(n + 32, 63)
S ← rS[32]
rA ← r & m | (64)S & ¬ m
XER[CA] ← S & ((r & ¬ m)[32-63] ≠ 0)

```

The contents of the low-order 32 bits of **rS** are shifted right **SH** bits. Bits shifted out of position 63 are lost. Bit 32 of **rS** is replicated to fill the vacated positions on the left. The 32-bit result is placed into the low-order 32 bits of **rA**. Bit 32 of **rS** is replicated to fill the high-order 32 bits of **rA**. **XER[CA]** is set if the low-order 32 bits of **rS** contain a negative number and any 1 bits are shifted out of position 63; otherwise **XER[CA]** is cleared. A shift amount of zero causes **rA** to receive the sign-extended value of the low-order 32 bits of **rS**, and **XER[CA]** to be cleared.

Note that the **srawi** instruction, followed by **addze**, can be used to divide quickly by 2^n . The setting of the CA bit, by **srawi**, is independent of mode.

Other registers altered:

- Condition Register (CR0 field):
Affected: LT, GT, EQ, SO (if Rc = 1)
- XER:
Affected: CA

PowerPC Architecture Level	Supervisor Level	32-Bit	64-Bit	64-Bit Bridge	Optional	Form
UISA						X

srd_x

64-Bit Implementations Only

srd_x

Shift Right Double Word

srd **rA,rS,rB** (**Rc = 0**)
srd. **rA,rS,rB** (**Rc = 1**)

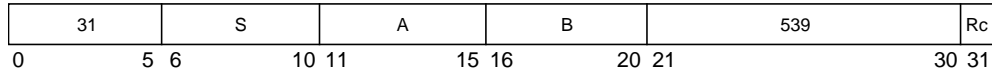

```

n ← rB[58-63]
r ← ROTL[64](rS, 64 - n)
if rB[57] = 0 then
  m ← MASK(n, 63)
else m ← (64)0
rA ← r & m

```

The contents of **rS** are shifted right the number of bits specified by the low-order seven bits of **rB**. Bits shifted out of position 63 are lost. Zeros are supplied to the vacated positions on the left. The result is placed into **rA**. Shift amounts from 64 to 127 give a zero result.

This instruction is defined only for 64-bit implementations. Using it on a 32-bit implementation will cause the system illegal instruction error handler to be invoked.

Other registers altered:

- Condition Register (CR0 field):
 Affected: LT, GT, EQ, SO (if **Rc = 1**)

PowerPC Architecture Level	Supervisor Level	32-Bit	64-Bit	64-Bit Bridge	Optional	Form
UISA			√			X

srw_x

Shift Right Word

srw_x

srw **rA,rS,rB** (**Rc = 0**)

srw. **rA,rS,rB** (**Rc = 1**)

[POWER mnemonics: **sr**, **sr.**]

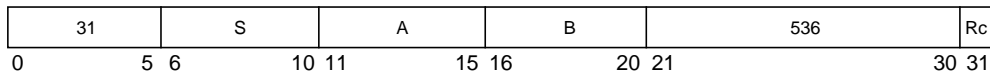

```

n ← rB[58-63]
r ← ROTL[32](rS[32-63], 64 - n)
if rB[58] = 0 then
    m ← MASK(n + 32, 63)
else m ← (64)0
rA ← r & m

```

The contents of the low-order 32 bits of **rS** are shifted right the number of bits specified by the low-order six bits of **rB**. Bits shifted out of position 63 are lost. Zeros are supplied to the vacated positions on the left. The 32-bit result is placed into the low-order 32 bits of **rA**. The high-order 32 bits of **rA** are cleared. Shift amounts from 32 to 63 give a zero result.

Other registers altered:

- Condition Register (CR0 field):
Affected: LT, GT, EQ, SO (if **Rc = 1**)

PowerPC Architecture Level	Supervisor Level	32-Bit	64-Bit	64-Bit Bridge	Optional	Form
UISA						X

stb

Store Byte

stb

stb $rS, d(rA)$

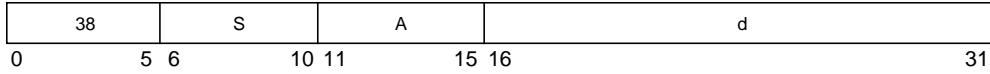

```

if rA = 0 then b ← 0
else b ← (rA)
EA ← b + EXTS(d)
MEM(EA, 1) ← rS[56-63]

```

EA is the sum $(rA|0) + d$. The contents of the low-order eight bits of rS are stored into the byte in memory addressed by EA.

Other registers altered:

- None

PowerPC Architecture Level	Supervisor Level	32-Bit	64-Bit	64-Bit Bridge	Optional	Form
----------------------------	------------------	--------	--------	---------------	----------	------

UISA						D
------	--	--	--	--	--	---

stbux

Store Byte with Update Indexed

stbux

stbux **rS,rA,rB**

Reserved

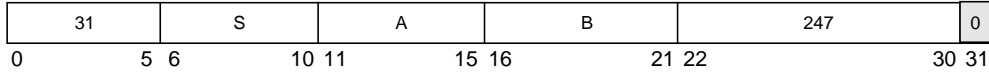

$EA \leftarrow (rA) + (rB)$
 $MEM(EA, 1) \leftarrow rS[56-63]$
 $rA \leftarrow EA$

EA is the sum (rA) + (rB). The contents of the low-order eight bits of rS are stored into the byte in memory addressed by EA.

EA is placed into rA.

If rA = 0, the instruction form is invalid.

Other registers altered:

- None

PowerPC Architecture Level	Supervisor Level	32-Bit	64-Bit	64-Bit Bridge	Optional	Form
----------------------------	------------------	--------	--------	---------------	----------	------

UISA						X
------	--	--	--	--	--	---

stbx

Store Byte Indexed

stbx

stbx **rS,rA,rB**

Reserved

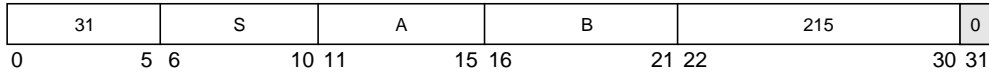

```

if rA = 0 then b ← 0
else b ← (rA)
EA ← b + (rB)
MEM(EA, 1) ← rS[56-63]

```

EA is the sum (rA|0) + (rB). The contents of the low-order eight bits of rS are stored into the byte in memory addressed by EA.

Other registers altered:

- None

PowerPC Architecture Level	Supervisor Level	32-Bit	64-Bit	64-Bit Bridge	Optional	Form
UIA						X

std

64-Bit Implementations Only

std

Store Double Word

std

rS,ds(rA)

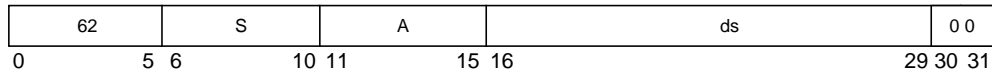

```

if rA = 0 then b ← 0
else b ← (rA)
EA ← b + EXTS(ds || 0b00)
(MEM(EA, 8)) ← (rS)

```

EA is the sum (rA|0) + (ds || 0b00). The contents of rS are stored into the double word in memory addressed by EA.

This instruction is defined only for 64-bit implementations. Using it on a 32-bit implementation will cause the system illegal instruction error handler to be invoked.

Other registers altered:

- None

PowerPC Architecture Level	Supervisor Level	32-Bit	64-Bit	64-Bit Bridge	Optional	Form
UISA			√			DS

stdcx. 64-Bit Implementations Only

Store Double Word Conditional Indexed

stdcx.

stdcx. rS,rA,rB

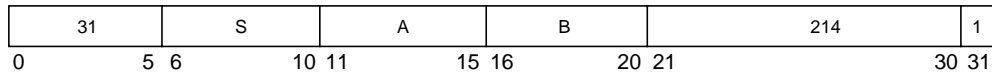

```
if rA = 0 then b ← 0
else b ← (rA)
EA ← b + (rB)
if RESERVE then
  if RESERVE_ADDR = physical_addr(EA)
    MEM(EA, 8) ← (rS)
    CR0 ← 0b00 || 0b1 || XER[SO]
  else
    u ← undefined 1-bit value
    if u then MEM(EA, 8) ← (rS)
    CR0 ← 0b00 || u || XER[SO]
  RESERVE ← 0
else
  CR0 ← 0b00 || 0b0 || XER[SO]
```

EA is the sum (rA|0) + (rB).

If a reservation exists, and the memory address specified by the **stdcx.** instruction is the same as that specified by the load and reserve instruction that established the reservation, the contents of rS are stored into the double word in memory addressed by EA and the reservation is cleared.

If a reservation exists, but the memory address specified by the **stdcx.** instruction is not the same as that specified by the load and reserve instruction that established the reservation, the reservation is cleared, and it is undefined whether the contents of rS are stored into the double word in memory addressed by EA.

If no reservation exists, the instruction completes without altering memory.

CR0 field is set to reflect whether the store operation was performed as follows.

```
CR0[LT GT EQ S0] = 0b00 || store_performed || XER[SO]
```

EA must be a multiple of eight. If it is not, either the system alignment exception handler is invoked or the results are boundedly undefined. For additional information about alignment and DSI exceptions, see Section 6.4.3, “DSI Exception (0x00300).”

Note that, when used correctly, the load and reserve and store conditional instructions can provide an atomic update function for a single aligned word (load word and reserve and store word conditional) or double word (load double word and reserve and store double word conditional) of memory.

In general, correct use requires that load word and reserve be paired with store word conditional, and load double word and reserve with store double word conditional, with the same memory address specified by both instructions of the pair. The only exception is that an unpaired store word conditional or store double word conditional instruction to any (scratch) EA can be used to clear any reservation held by the processor. Examples of correct uses of these instructions, to emulate primitives such as fetch and add, test and set, and compare and swap can be found in Appendix E, “Synchronization Programming Examples.”

A reservation is cleared if any of the following events occurs:

- The processor holding the reservation executes another load and reserve instruction; this clears the first reservation and establishes a new one.
- The processor holding the reservation executes a store conditional instruction to any address.
- Another processor executes any store instruction to the address associated with the reservation.]
- Any mechanism, other than the processor holding the reservation, stores to the address associated with the reservation.

This instruction is defined only for 64-bit implementations. Using it on a 32-bit implementation will cause the system illegal instruction error handler to be invoked.

Other registers altered:

- Condition Register (CR0 field):
Affected: LT, GT, EQ, SO

PowerPC Architecture Level	Supervisor Level	32-Bit	64-Bit	64-Bit Bridge	Optional	Form
UISA			√			X

stdu

64-Bit Implementations Only

stdu

Store Double Word with Update

stdu $rS, ds(rA)$

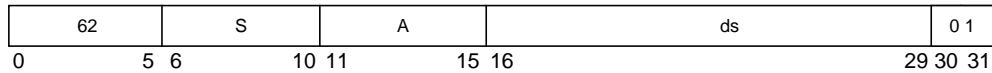

$EA \leftarrow (rA) + EXT(S(ds \parallel 0b00))$
 $(MEM(EA, 8)) \leftarrow (rS)$
 $rA \leftarrow EA$

EA is the sum $(rA) + (ds \parallel 0b00)$. The contents of rS are stored into the double word in memory addressed by EA.

EA is placed into rA .

If $rA = 0$, the instruction form is invalid.

This instruction is defined only for 64-bit implementations. Using it on a 32-bit implementation will cause the system illegal instruction error handler to be invoked.

Other registers altered:

- None

PowerPC Architecture Level	Supervisor Level	32-Bit	64-Bit	64-Bit Bridge	Optional	Form
UIA			√			DS

stdux

64-Bit Implementations Only

stdux

Store Double Word with Update Indexed

stdux **rS,rA,rB**

Reserved

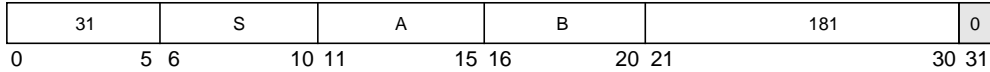

$EA \leftarrow (rA) + (rB)$
 $MEM(EA, 8) \leftarrow (rS)$
 $rA \leftarrow EA$

EA is the sum $(rA) + (rB)$. The contents of **rS** are stored into the double word in memory addressed by EA.

EA is placed into **rA**.

If **rA** = 0, the instruction form is invalid.

This instruction is defined only for 64-bit implementations. Using it on a 32-bit implementation will cause the system illegal instruction error handler to be invoked.

Other registers altered:

- None

PowerPC Architecture Level	Supervisor Level	32-Bit	64-Bit	64-Bit Bridge	Optional	Form
UISA			√			X

stdx

64-Bit Implementations Only

stdx

Store Double Word Indexed

stdx

rS,rA,rB

Reserved

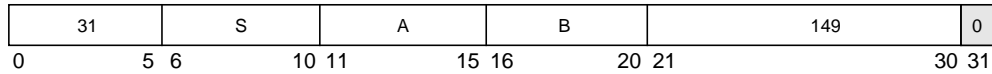

```

if rA = 0 then b ← 0
else    b ← (rA)
EA ← b + (rB)
(MEM(EA, 8)) ← (rS)

```

EA is the sum $(rA|0) + (rB)$. The contents of rS are stored into the double word in memory addressed by EA.

This instruction is defined only for 64-bit implementations. Using it on a 32-bit implementation will cause the system illegal instruction error handler to be invoked.

Other registers altered:

- None

PowerPC Architecture Level	Supervisor Level	32-Bit	64-Bit	64-Bit Bridge	Optional	Form
UISA			√			X

stfd

Store Floating-Point Double

stfd

stfd **frS,d(rA)**

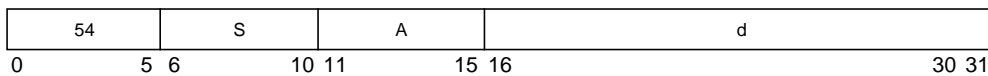

```

if rA = 0 then b ← 0
else b ← (rA)
EA ← b + EXTS(d)
MEM(EA, 8) ← (frS)

```

EA is the sum (rA|0) + d.

The contents of register frS are stored into the double word in memory addressed by EA.

Other registers altered:

- None

PowerPC Architecture Level	Supervisor Level	32-Bit	64-Bit	64-Bit Bridge	Optional	Form
----------------------------	------------------	--------	--------	---------------	----------	------

UISA						D
------	--	--	--	--	--	---

stfdu

Store Floating-Point Double with Update

stfdu

stfdu **frS,d(rA)**

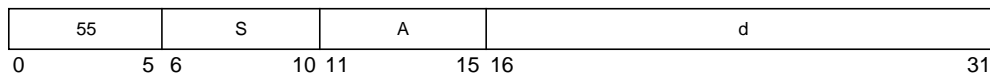

$EA \leftarrow (rA) + EXTS(d)$
 $MEM(EA, 8) \leftarrow (frS)$
 $rA \leftarrow EA$

EA is the sum (rA) + d.

The contents of register frS are stored into the double word in memory addressed by EA.

EA is placed into rA.

If rA = 0, the instruction form is invalid.

Other registers altered:

- None

PowerPC Architecture Level	Supervisor Level	32-Bit	64-Bit	64-Bit Bridge	Optional	Form
----------------------------	------------------	--------	--------	---------------	----------	------

UISA						D
------	--	--	--	--	--	---

stfdux

Store Floating-Point Double with Update Indexed

stfdux

stfdux **frS,rA,rB**

Reserved

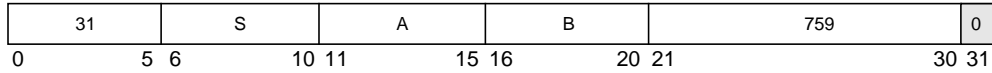

$EA \leftarrow (rA) + (rB)$
 $MEM(EA, 8) \leftarrow (frS)$
 $rA \leftarrow EA$

EA is the sum $(rA) + (rB)$.

The contents of register **frS** are stored into the double word in memory addressed by EA.

EA is placed into **rA**.

If **rA** = 0, the instruction form is invalid.

Other registers altered:

- None

PowerPC Architecture Level Supervisor Level 32-Bit 64-Bit 64-Bit Bridge Optional Form

UIA						X
-----	--	--	--	--	--	---

stfdx

Store Floating-Point Double Indexed

stfdx

stfdx **frS,rA,rB**

Reserved

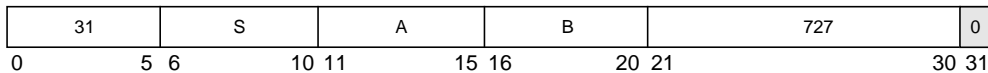

```

if rA = 0 then b ← 0
else b ← (rA)
EA ← b + (rB)
MEM(EA, 8) ← (frS)

```

EA is the sum (rA|0) + rB.

The contents of register frS are stored into the double word in memory addressed by EA.

Other registers altered:

- None

PowerPC Architecture Level	Supervisor Level	32-Bit	64-Bit	64-Bit Bridge	Optional	Form
UISA						X

stfiwx

Store Floating-Point as Integer Word Indexed

stfiwx

stfiwx **frS,rA,rB**

Reserved

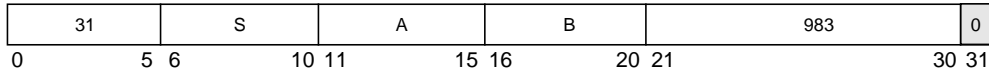

```

if rA = 0 then b ← 0
else    b ← (rA)
EA ← b + (rB)
MEM(EA, 4) ← frS[32-63]

```

EA is the sum (rA|0) + (rB).

The contents of the low-order 32 bits of register **frS** are stored, without conversion, into the word in memory addressed by EA.

If the contents of register **frS** were produced, either directly or indirectly, by an **lfs** instruction, a single-precision arithmetic instruction, or **frsp**, then the value stored is undefined. The contents of **frS** are produced directly by such an instruction if **frS** is the target register for the instruction. The contents of **frS** are produced indirectly by such an instruction if **frS** is the final target register of a sequence of one or more floating-point move instructions, with the input to the sequence having been produced directly by such an instruction.

This instruction is defined as optional by the PowerPC architecture to ensure backwards compatibility with earlier processors; however, it will likely be required for subsequent PowerPC processors.

Other registers altered:

- None

PowerPC Architecture Level	Supervisor Level	32-Bit	64-Bit	64-Bit Bridge	Optional	Form
UISA					√	X

stfs

Store Floating-Point Single

stfs

stfs **frS,d(rA)**

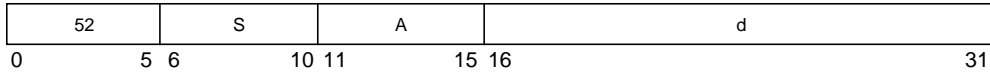

```

if rA = 0 then b ← 0
else    b ← (rA)
EA ← b + EXTS(d)
MEM(EA, 4) ← SINGLE(frS)

```

EA is the sum (rA|0) + d.

The contents of register **frS** are converted to single-precision and stored into the word in memory addressed by EA. Note that the value to be stored should be in single-precision format prior to the execution of the **stfs** instruction. For a discussion on floating-point store conversions, see Section D.7, “Floating-Point Store Instructions.”

Other registers altered:

- None

PowerPC Architecture Level	Supervisor Level	32-Bit	64-Bit	64-Bit Bridge	Optional	Form
UIA						D

stfsu

Store Floating-Point Single with Update

stfsu

stfsu **frS,d(rA)**

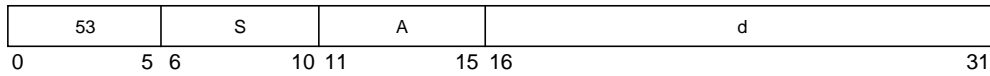

```
EA ← (rA) + EXTS(d)
MEM(EA, 4) ← SINGLE(frS)
rA ← EA
```

EA is the sum (rA) + d.

The contents of **frS** are converted to single-precision and stored into the word in memory addressed by EA. Note that the value to be stored should be in single-precision format prior to the execution of the **stfsu** instruction. For a discussion on floating-point store conversions, see Section D.7, “Floating-Point Store Instructions.”

EA is placed into **rA**.

If **rA** = 0, the instruction form is invalid.

Other registers altered:

- None

PowerPC Architecture Level	Supervisor Level	32-Bit	64-Bit	64-Bit Bridge	Optional	Form
UISA						D

stfsux

Store Floating-Point Single with Update Indexed

stfsux

stfsux **frS,rA,rB**

Reserved

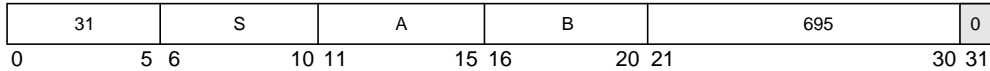

$EA \leftarrow (rA) + (rB)$
 $MEM(EA, 4) \leftarrow SINGLE(frS)$
 $rA \leftarrow EA$

EA is the sum (rA) + (rB).

The contents of frS are converted to single-precision and stored into the word in memory addressed by EA. For a discussion on floating-point store conversions, see Section D.7, “Floating-Point Store Instructions.”

EA is placed into rA.

If rA = 0, the instruction form is invalid.

Other registers altered:

- None

PowerPC Architecture Level	Supervisor Level	32-Bit	64-Bit	64-Bit Bridge	Optional	Form
----------------------------	------------------	--------	--------	---------------	----------	------

UISA						X
------	--	--	--	--	--	---

stfsx

Store Floating-Point Single Indexed

stfsx

stfsx **frS,rA,rB**

Reserved

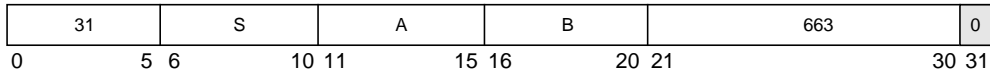

```

if rA = 0 then b ← 0
else b ← (rA)
EA ← b + (rB)
MEM(EA, 4) ← SINGLE(frS)

```

EA is the sum (rA|0) + (rB).

The contents of register **frS** are converted to single-precision and stored into the word in memory addressed by EA. For a discussion on floating-point store conversions, see Section D.7, “Floating-Point Store Instructions.”

Other registers altered:

- None

PowerPC Architecture Level	Supervisor Level	32-Bit	64-Bit	64-Bit Bridge	Optional	Form
UISA						X

sthbrx

Store Half Word Byte-Reverse Indexed

sthbrx

sthbrx **rS,rA,rB**

Reserved

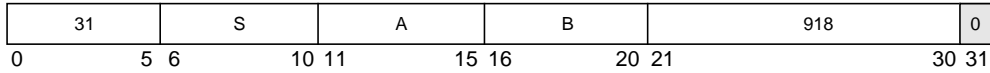

```

if rA = 0 then b ← 0
else    b ← (rA)
EA ← b + (rB)
MEM(EA, 2) ← rS[56-63] || rS[48-55]

```

EA is the sum (rA|0) + (rB). The contents of the low-order eight bits of rS are stored into bits 0–7 of the half word in memory addressed by EA. The contents of the subsequent low-order eight bits of rS are stored into bits 8–15 of the half word in memory addressed by EA.

Other registers altered:

- None

PowerPC Architecture Level	Supervisor Level	32-Bit	64-Bit	64-Bit Bridge	Optional	Form
UIA						X

sth

Store Half Word with Update

sth

sth **rS,d(rA)**

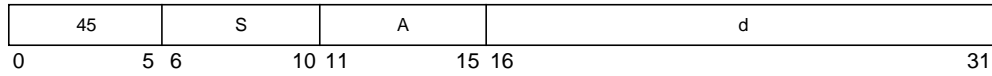

```
EA ← (rA) + EXTS(d)
MEM(EA, 2) ← rS[48-63]
rA ← EA
```

EA is the sum (rA) + d. The contents of the low-order 16 bits of rS are stored into the half word in memory addressed by EA.

EA is placed into rA.

If rA = 0, the instruction form is invalid.

Other registers altered:

- None

PowerPC Architecture Level	Supervisor Level	32-Bit	64-Bit	64-Bit Bridge	Optional	Form
----------------------------	------------------	--------	--------	---------------	----------	------

UISA						D
------	--	--	--	--	--	---

sthux

Store Half Word with Update Indexed

sthux

sthux **rS,rA,rB**

Reserved

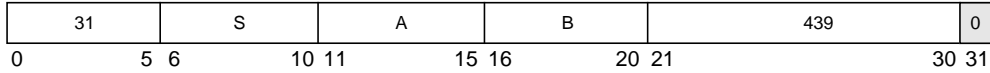

$EA \leftarrow (rA) + (rB)$
 $MEM(EA, 2) \leftarrow rS[48-63]$
 $rA \leftarrow EA$

EA is the sum (rA) + (rB). The contents of the low-order 16 bits of rS are stored into the half word in memory addressed by EA.

EA is placed into rA.

If rA = 0, the instruction form is invalid.

Other registers altered:

- None

PowerPC Architecture Level	Supervisor Level	32-Bit	64-Bit	64-Bit Bridge	Optional	Form
----------------------------	------------------	--------	--------	---------------	----------	------

UISA						X
------	--	--	--	--	--	---

sthx

Store Half Word Indexed

sthx

sthx **rS,rA,rB**

Reserved

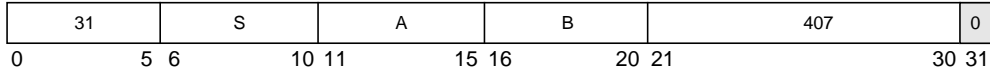

```

if rA = 0 then b ← 0
else    b ← (rA)
EA ← b + (rB)
MEM(EA, 2) ← rS[48-63]

```

EA is the sum (rA|0) + (rB). The contents of the low-order 16 bits of rS are stored into the half word in memory addressed by EA.

Other registers altered:

- None

PowerPC Architecture Level	Supervisor Level	32-Bit	64-Bit	64-Bit Bridge	Optional	Form
----------------------------	------------------	--------	--------	---------------	----------	------

UISA						X
------	--	--	--	--	--	---

stmw

Store Multiple Word

stmw

stmw **rS,d(rA)**

[POWER mnemonic: **stm**]

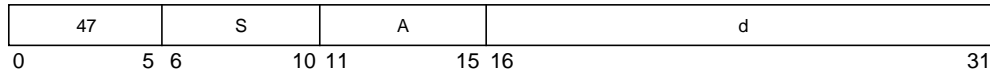

```

if rA = 0 then b ← 0
else    b ← (rA)
EA ← b + EXTS(d)
r ← rS
do while r ≤ 31
    MEM(EA, 4) ← GPR(r)[32-63]
    r ← r + 1
    EA ← EA + 4

```

EA is the sum (rA|0) + d.

$$n = (32 - rS).$$

n consecutive words starting at EA are stored from the low-order 32 bits of GPRs rS through r31. For example, if rS = 30, 2 words are stored.

EA must be a multiple of four. If it is not, either the system alignment exception handler is invoked or the results are boundedly undefined. For additional information about alignment and DSI exceptions, see Section 6.4.3, “DSI Exception (0x00300).”

Note that, in some implementations, this instruction is likely to have a greater latency and take longer to execute, perhaps much longer, than a sequence of individual load or store instructions that produce the same results.

Other registers altered:

- None

PowerPC Architecture Level	Supervisor Level	32-Bit	64-Bit	64-Bit Bridge	Optional	Form
UI5A						D

stswi

Store String Word Immediate

stswi

stswi **rS,rA,NB**

[POWER mnemonic: **stsi**]

Reserved

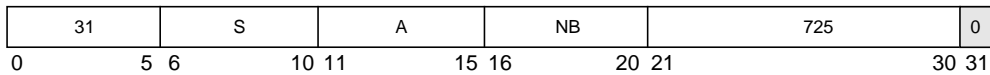

```

if rA = 0 then EA ← 0
else EA ← (rA)
if NB = 0 then n ← 32
else n ← NB
r ← rS - 1
i ← 32
do while n > 0
  if i = 32 then r ← r + 1 (mod 32)
  MEM(EA, 1) ← GPR(r)[i-i + 7]
  i ← i + 8
  if i = 64 then i ← 32
  EA ← EA + 1
  n ← n - 1

```

EA is (rA)0. Let $n = NB$ if $NB \neq 0$, $n = 32$ if $NB = 0$; n is the number of bytes to store. Let $nr = \text{CEIL}(n \div 4)$; nr is the number of registers to supply data.

n consecutive bytes starting at EA are stored from GPRs rS through rS + nr - 1. Data is stored from the low-order four bytes of each GPR. Bytes are stored left to right from each register. The sequence of registers wraps around through r0 if required.

Under certain conditions (for example, segment boundary crossing) the data alignment exception handler may be invoked. For additional information about data alignment exceptions, see Section 6.4.3, “DSI Exception (0x00300).”

Note that, in some implementations, this instruction is likely to have a greater latency and take longer to execute, perhaps much longer, than a sequence of individual load or store instructions that produce the same results.

Other registers altered:

- None

PowerPC Architecture Level	Supervisor Level	32-Bit	64-Bit	64-Bit Bridge	Optional	Form
UISA						X

stswx

Store String Word Indexed

stswx

stswx **rS,rA,rB**

[POWER mnemonic: **stsx**]

Reserved

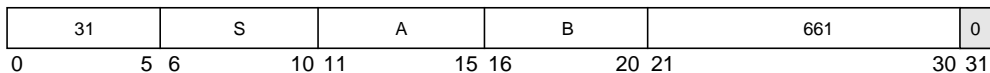

```

if rA = 0 then b ← 0
else    b ← (rA)
EA ← b + (rB)
n ← XER[25-31]
r ← rS - 1
i ← 32
do while n > 0
  if i = 32 then r ← r + 1 (mod 32)
  MEM(EA, 1) ← GPR(r)[i-i + 7]
  i ← i + 8
  if i = 64 then i ← 32
  EA ← EA + 1
  n ← n - 1

```

EA is the sum (rA[0] + (rB)). Let $n = XER[25-31]$; n is the number of bytes to store. Let $nr = CEIL(n \div 4)$; nr is the number of registers to supply data.

n consecutive bytes starting at EA are stored from GPRs rS through rS + nr - 1. Data is stored from the low-order four bytes of each GPR. Bytes are stored left to right from each register. The sequence of registers wraps around through r0 if required. If $n = 0$, no bytes are stored.

Under certain conditions (for example, segment boundary crossing) the data alignment exception handler may be invoked. For additional information about data alignment exceptions, see Section 6.4.3, “DSI Exception (0x00300).”

Note that, in some implementations, this instruction is likely to have a greater latency and take longer to execute, perhaps much longer, than a sequence of individual load or store instructions that produce the same results.

Other registers altered:

- None

PowerPC Architecture Level	Supervisor Level	32-Bit	64-Bit	64-Bit Bridge	Optional	Form
----------------------------	------------------	--------	--------	---------------	----------	------

UISA						X
------	--	--	--	--	--	---

stw

Store Word

stw

stw **rS,d(rA)**

[POWER mnemonic: **st**]

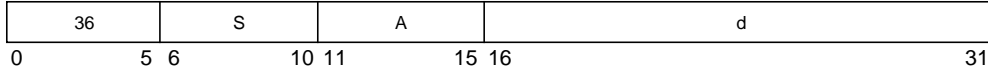

```

if rA = 0 then b ← 0
else    b ← (rA)
EA ← b + EXTS(d)
MEM(EA, 4) ← rS[32-63]

```

EA is the sum (rA|0) + d. The contents of the low-order 32 bits of rS are stored into the word in memory addressed by EA.

Other registers altered:

- None

PowerPC Architecture Level	Supervisor Level	32-Bit	64-Bit	64-Bit Bridge	Optional	Form
UIA						D

stwbrx

Store Word Byte-Reverse Indexed

stwbrx **rS,rA,rB**

[POWER mnemonic: **stbrx**]

stwbrx

Reserved

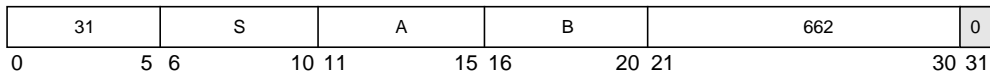

```

if rA = 0 then b ← 0
else    b ← (rA)
EA ← b + (rB)
MEM(EA, 4) ← rS[56-63] || rS[48-55] || rS[40-47] || rS[32-39]

```

EA is the sum (rA|0) + (rB). The contents of the low-order eight bits of rS are stored into bits 0–7 of the word in memory addressed by EA. The contents of the subsequent eight low-order bits of rS are stored into bits 8–15 of the word in memory addressed by EA. The contents of the subsequent eight low-order bits of rS are stored into bits 16–23 of the word in memory addressed by EA. The contents of the subsequent eight low-order bits of rS are stored into bits 24–31 of the word in memory addressed by EA.

Other registers altered:

- None

PowerPC Architecture Level	Supervisor Level	32-Bit	64-Bit	64-Bit Bridge	Optional	Form
UISA						X

The granularity with which reservations are managed is implementation-dependent. Therefore, the memory to be accessed by the load and reserve and store conditional instructions should be allocated by a system library program.

Other registers altered:

- Condition Register (CR0 field):
Affected: LT, GT, EQ, SO

PowerPC Architecture Level	Supervisor Level	32-Bit	64-Bit	64-Bit Bridge	Optional	Form
UIA						X

stwu

Store Word with Update

stwu

stwu **rS,d(rA)**

[POWER mnemonic: **stu**]

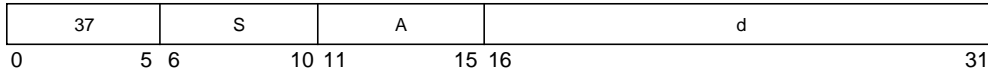

$EA \leftarrow (rA) + EXTS(d)$
 $MEM(EA, 4) \leftarrow rS[32-63]$
 $rA \leftarrow EA$

EA is the sum (rA) + d. The contents of the low-order 32 bits of rS are stored into the word in memory addressed by EA.

EA is placed into rA.

If rA = 0, the instruction form is invalid.

Other registers altered:

- None

PowerPC Architecture Level	Supervisor Level	32-Bit	64-Bit	64-Bit Bridge	Optional	Form
----------------------------	------------------	--------	--------	---------------	----------	------

UISA						D
------	--	--	--	--	--	---

stwux

Store Word with Update Indexed

stwux

stwux **rS,rA,rB**

[POWER mnemonic: **stux**]

Reserved

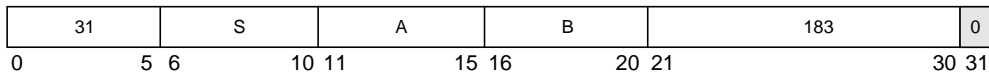

$EA \leftarrow (rA) + (rB)$
 $MEM(EA, 4) \leftarrow rS[32-63]$
 $rA \leftarrow EA$

EA is the sum (rA) + (rB). The contents of the low-order 32 bits of rS are stored into the word in memory addressed by EA.

EA is placed into rA.

If rA = 0, the instruction form is invalid.

Other registers altered:

- None

PowerPC Architecture Level	Supervisor Level	32-Bit	64-Bit	64-Bit Bridge	Optional	Form
----------------------------	------------------	--------	--------	---------------	----------	------

UIA						X
-----	--	--	--	--	--	---

stwx

Store Word Indexed

stwx

stwx **rS,rA,rB**

[POWER mnemonic: **stx**]

Reserved

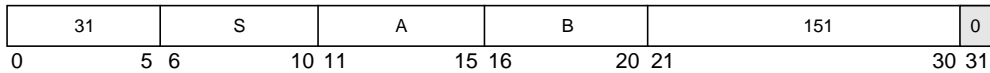

```

if rA = 0 then b ← 0
else    b ← (rA)
EA ← b + (rB)
MEM(EA, 4) ← rS[32-63]

```

EA is the sum (rA|0) + (rB). The contents of the low-order 32 bits of rS are is stored into the word in memory addressed by EA.

Other registers altered:

- None

PowerPC Architecture Level	Supervisor Level	32-Bit	64-Bit	64-Bit Bridge	Optional	Form
UISA						X

subf_x

Subtract From

subf_x

subf rD,rA,rB (OE = 0 Rc = 0)

subf. rD,rA,rB (OE = 0 Rc = 1)

subfo rD,rA,rB (OE = 1 Rc = 0)

subfo. rD,rA,rB (OE = 1 Rc = 1)

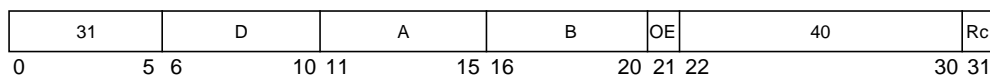

$$rD \leftarrow \neg (rA) + (rB) + 1$$

The sum $\neg (rA) + (rB) + 1$ is placed into rD.

The **subf** instruction is preferred for subtraction because it sets few status bits.

Other registers altered:

- Condition Register (CR0 field):
Affected: LT, GT, EQ, SO (if Rc = 1)
- XER:
Affected: SO, OV (if OE = 1)

Simplified mnemonics:

sub rD,rA,rB equivalent to **subf** rD,rB,rA

PowerPC Architecture Level	Supervisor Level	32-Bit	64-Bit	64-Bit Bridge	Optional	Form
----------------------------	------------------	--------	--------	---------------	----------	------

UISA						XO
------	--	--	--	--	--	----

subfc_x

Subtract from Carrying

subfc_x

subfc **rD,rA,rB** (OE = 0 R_c = 0)
subfc. **rD,rA,rB** (OE = 0 R_c = 1)
subfco **rD,rA,rB** (OE = 1 R_c = 0)
subfco. **rD,rA,rB** (OE = 1 R_c = 1)

[POWER mnemonics: **sf, sf., sfo, sfo.**]

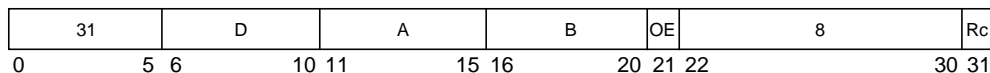

$$rD \leftarrow \neg(rA) + (rB) + 1$$

The sum $\neg(rA) + (rB) + 1$ is placed into **rD**.

Other registers altered:

- Condition Register (CR0 field):

Affected: LT, GT, EQ, SO (if R_c = 1)

Note: CR0 field may not reflect the infinitely precise result if overflow occurs (see XER below).

- XER:

Affected: CA

Affected: SO, OV (if OE = 1)

Note: The setting of the affected bits in the XER is mode-dependent, and reflects overflow of the 64-bit result in 64-bit mode and overflow of the low-order 32-bit result in 32-bit mode. For further information about 64-bit mode and 32-bit mode in 64-bit implementations, see Chapter 3, “Operand Conventions.”

Simplified mnemonics:

subc **rD,rA,rB** equivalent to **subfc** **rD,rB,rA**

PowerPC Architecture Level	Supervisor Level	32-Bit	64-Bit	64-Bit Bridge	Optional	Form
----------------------------	------------------	--------	--------	---------------	----------	------

UISA						XO
------	--	--	--	--	--	----

subfe_x

Subtract from Extended

subfe_x

subfe	rD,rA,rB	(OE = 0 Rc = 0)
subfe.	rD,rA,rB	(OE = 0 Rc = 1)
subfeo	rD,rA,rB	(OE = 1 Rc = 0)
subfeo.	rD,rA,rB	(OE = 1 Rc = 1)

[POWER mnemonics: **sfe**, **sfe.**, **sfeo**, **sfeo.**]

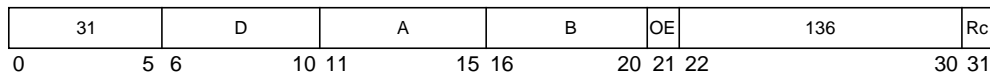

$$rD \leftarrow \neg (rA) + (rB) + XER[CA]$$

The sum $\neg (rA) + (rB) + XER[CA]$ is placed into **rD**.

Other registers altered:

- Condition Register (CR0 field):

Affected: LT, GT, EQ, SO (if Rc = 1)

Note: CR0 field may not reflect the infinitely precise result if overflow occurs (see XER below).

- XER:

Affected: CA

Affected: SO, OV (if OE = 1)

Note: The setting of the affected bits in the XER is mode-dependent, and reflects overflow of the 64-bit result in 64-bit mode and overflow of the low-order 32-bit result in 32-bit mode. For further information about 64-bit mode and 32-bit mode in 64-bit implementations, see Chapter 3, “Operand Conventions.”

PowerPC Architecture Level	Supervisor Level	32-Bit	64-Bit	64-Bit Bridge	Optional	Form
UIA						XO

subfic

Subtract from Immediate Carrying

subfic **rD,rA,SIMM**

[POWER mnemonic: **sfi**]

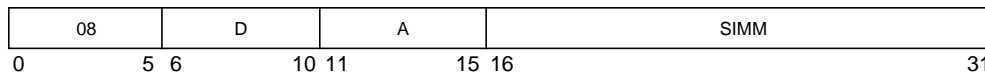

$$rD \leftarrow \neg (rA) + \text{EXTS}(SIMM) + 1$$

The sum $\neg(rA) + \text{EXTS}(SIMM) + 1$ is placed into rD.

Other registers altered:

- XER:

Affected: CA

Note: The setting of the affected bits in the XER is mode-dependent, and reflects overflow of the 64-bit result in 64-bit mode and overflow of the low-order 32-bit result in 32-bit mode. For further information about 64-bit mode and 32-bit mode in 64-bit implementations, see Chapter 3, “Operand Conventions.”

PowerPC Architecture Level	Supervisor Level	32-Bit	64-Bit	64-Bit Bridge	Optional	Form
----------------------------	------------------	--------	--------	---------------	----------	------

UISA						D
------	--	--	--	--	--	---

subfme_x

Subtract from Minus One Extended

subfme_x

subfme **rD,rA** (OE = 0 Rc = 0)
subfme. **rD,rA** (OE = 0 Rc = 1)
subfmeo **rD,rA** (OE = 1 Rc = 0)
subfmeo. **rD,rA** (OE = 1 Rc = 1)

[POWER mnemonics: **sfme**, **sfme.**, **sfmeo**, **sfmeo.**]

Reserved

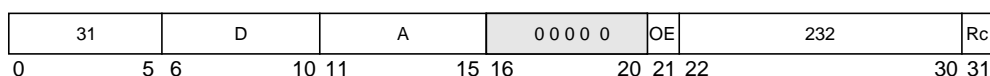

$$rD \leftarrow \neg (rA) + XER[CA] - 1$$

The sum $\neg (rA) + XER[CA] + (64)1$ is placed into **rD**.

Other registers altered:

- Condition Register (CR0 field):

Affected: LT, GT, EQ, SO (if Rc = 1)

Note: CR0 field may not reflect the infinitely precise result if overflow occurs (see XER below).

- XER:

Affected: CA

Affected: SO, OV (if OE = 1)

Note: The setting of the affected bits in the XER is mode-dependent, and reflects overflow of the 64-bit result in 64-bit mode and overflow of the low-order 32-bit result in 32-bit mode. For further information about 64-bit mode and 32-bit mode in 64-bit implementations, see Chapter 3, “Operand Conventions.”

PowerPC Architecture Level	Supervisor Level	32-Bit	64-Bit	64-Bit Bridge	Optional	Form
UISA						XO

subfze_x

Subtract from Zero Extended

subfze_x

subfze	rD,rA	(OE = 0 Rc = 0)
subfze.	rD,rA	(OE = 0 Rc = 1)
subfzeo	rD,rA	(OE = 1 Rc = 0)
subfzeo.	rD,rA	(OE = 1 Rc = 1)

[POWER mnemonics: **sfze**, **sfze.**, **sfzeo**, **sfzeo.**]

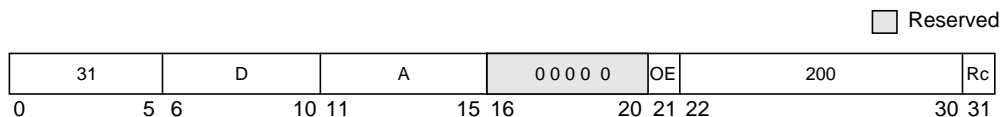

$$rD \leftarrow \neg (rA) + XER[CA]$$

The sum $\neg (rA) + XER[CA]$ is placed into **rD**.

Other registers altered:

- Condition Register (CR0 field):
Affected: LT, GT, EQ, SO (if Rc = 1)
Note: CR0 field may not reflect the infinitely precise result if overflow occurs (see XER below).
- XER:
Affected: CA
Affected: SO, OV (if OE = 1)
Note: The setting of the affected bits in the XER is mode-dependent, and reflects overflow of the 64-bit result in 64-bit mode and overflow of the low-order 32-bit result in 32-bit mode. For further information about 64-bit mode and 32-bit mode in 64-bit implementations, see Chapter 3, “Operand Conventions.”

PowerPC Architecture Level	Supervisor Level	32-Bit	64-Bit	64-Bit Bridge	Optional	Form
UISA						XO

sync

Synchronize

sync

[POWER mnemonic: **dcs**]

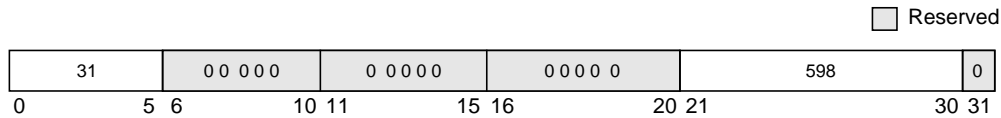

The **sync** instruction provides an ordering function for the effects of all instructions executed by a given processor. Executing a **sync** instruction ensures that all instructions preceding the **sync** instruction appear to have completed before the **sync** instruction completes, and that no subsequent instructions are initiated by the processor until after the **sync** instruction completes. When the **sync** instruction completes, all external accesses caused by instructions preceding the **sync** instruction will have been performed with respect to all other mechanisms that access memory. For more information on how the **sync** instruction affects the VEA, refer to Chapter 5, “Cache Model and Memory Coherency.”

Multiprocessor implementations also send a **sync** address-only broadcast that is useful in some designs. For example, if a design has an external buffer that re-orders loads and stores for better bus efficiency, the **sync** broadcast signals to that buffer that previous loads/stores must be completed before any following loads/stores.

The **sync** instruction can be used to ensure that the results of all stores into a data structure, caused by store instructions executed in a “critical section” of a program, are seen by other processors before the data structure is seen as unlocked.

The functions performed by the **sync** instruction will normally take a significant amount of time to complete, so indiscriminate use of this instruction may adversely affect performance. In addition, the time required to execute **sync** may vary from one execution to another.

The **eiemo** instruction may be more appropriate than **sync** for many cases.

This instruction is execution synchronizing. For more information on execution synchronization, see Section 4.1.5, “Synchronizing Instructions.”

Other registers altered:

- None

PowerPC Architecture Level	Supervisor Level	32-Bit	64-Bit	64-Bit Bridge	Optional	Form
UISA						X

tdi

64-Bit Implementations Only

tdi

Trap Double Word Immediate

tdi TO,rA,SIMM

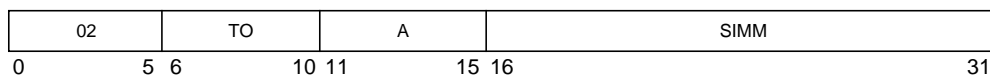

```

a ← (rA)
if (a < EXTS(SIMM)) & TO[0] then TRAP
if (a > EXTS(SIMM)) & TO[1] then TRAP
if (a = EXTS(SIMM)) & TO[2] then TRAP
if (a <U EXTS(SIMM)) & TO[3] then TRAP
if (a >U EXTS(SIMM)) & TO[4] then TRAP

```

The contents of **rA** are compared with the sign-extended value of the SIMM field. If any bit in the TO field is set and its corresponding condition is met by the result of the comparison, then the system trap handler is invoked.

This instruction is defined only for 64-bit implementations. Using it on a 32-bit implementation will cause the system illegal instruction error handler to be invoked.

Other registers altered:

- None

Simplified mnemonics:

tdlti	rA,value	equivalent to	tdi	16,rA,value
tdnei	rA,value	equivalent to	tdi	24,rA,value

PowerPC Architecture Level	Supervisor Level	32-Bit	64-Bit	64-Bit Bridge	Optional	Form
----------------------------	------------------	--------	--------	---------------	----------	------

UISA			√			D
------	--	--	---	--	--	---

tlbia

Translation Lookaside Buffer Invalidate All

tlbia

Reserved

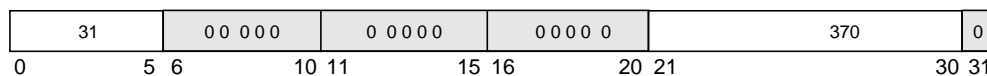

All TLB entries ← invalid

The entire translation lookaside buffer (TLB) is invalidated (that is, all entries are removed).

The TLB is invalidated regardless of the settings of MSR[IR] and MSR[DR]. The invalidation is done without reference to the SLB, segment table, or segment registers.

This instruction does not cause the entries to be invalidated in other processors.

This is a supervisor-level instruction and optional in the PowerPC architecture.

Other registers altered:

- None

PowerPC Architecture Level	Supervisor Level	32-Bit	64-Bit	64-Bit Bridge	Optional	Form
OEA	√				√	X

tlbie

Translation Lookaside Buffer Invalidate Entry

tlbie

tlbie

rB

[POWER mnemonic: **tlbi**]

Reserved

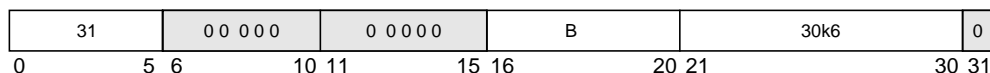

VPS ← rB[36-51]
 Identify TLB entries corresponding to VPS
 Each such TLB entry ← invalid

EA is the contents of rB. If the translation lookaside buffer (TLB) contains an entry corresponding to EA, that entry is made invalid (that is, removed from the TLB).

Multiprocessing implementations (for example, the 601, and 604) send a **tlbie** address-only broadcast over the address bus to tell other processors to invalidate the same TLB entry in their TLBs.

The TLB search is done regardless of the settings of MSR[IR] and MSR[DR]. The search is done based on a portion of the logical page number within a segment, without reference to the SLB, segment table, or segment registers. All entries matching the search criteria are invalidated.

Block address translation for EA, if any, is ignored. Refer to Section 7.5.3.4, “Synchronization of Memory Accesses and Referenced and Changed Bit Updates,” and Section 7.6.3, “Page Table Updates,” for other requirements associated with the use of this instruction.

This is a supervisor-level instruction and optional in the PowerPC architecture.

Other registers altered:

- None

PowerPC Architecture Level	Supervisor Level	32-Bit	64-Bit	64-Bit Bridge	Optional	Form
OEA	√				√	X

tlbsync

TLB Synchronize

tlbsync

Reserved

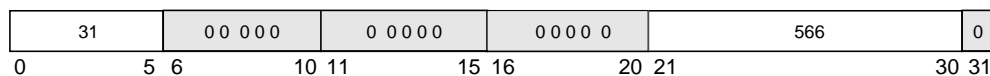

If an implementation sends a broadcast for **tlbie** then it will also send a broadcast for **tlbsync**. Executing a **tlbsync** instruction ensures that all **tlbie** instructions previously executed by the processor executing the **tlbsync** instruction have completed on all other processors.

The operation performed by this instruction is treated as a caching-inhibited and guarded data access with respect to the ordering done by **eiio**.

Note that the 601 expands the use of the **sync** instruction to cover **tlbsync** functionality.

Refer to Section 7.5.3.4, “Synchronization of Memory Accesses and Referenced and Changed Bit Updates,” and Section 7.6.3, “Page Table Updates,” for other requirements associated with the use of this instruction.

This instruction is supervisor-level and optional in the PowerPC architecture.

Other registers altered:

- None

PowerPC Architecture Level	Supervisor Level	32-Bit	64-Bit	64-Bit Bridge	Optional	Form
OEA	√				√	X

tw

Trap Word

tw

tw TO,rA,rB

[POWER mnemonic: t]

Reserved

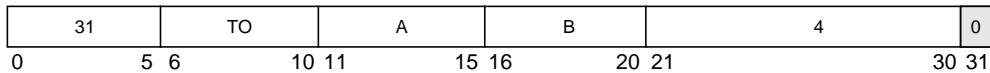

```

a ← EXTS(rA[32-63])
b ← EXTS(rB[32-63])
if (a < b) & TO[0] then TRAP
if (a > b) & TO[1] then TRAP
if (a = b) & TO[2] then TRAP
if (a <U b) & TO[3] then TRAP
if (a >U b) & TO[4] then TRAP

```

The contents of the low-order 32 bits of **rA** are compared with the contents of the low-order 32 bits of **rB**. If any bit in the TO field is set and its corresponding condition is met by the result of the comparison, then the system trap handler is invoked.

Other registers altered:

- None

Simplified mnemonics:

tw eq rA,rB	equivalent to	tw 4,rA,rB
tw lge rA,rB	equivalent to	tw 5,rA,rB
trap	equivalent to	tw 31,0,0

PowerPC Architecture Level	Supervisor Level	32-Bit	64-Bit	64-Bit Bridge	Optional	Form
----------------------------	------------------	--------	--------	---------------	----------	------

UISA						X
------	--	--	--	--	--	---

twi

Trap Word Immediate

twi

twi TO,rA,SIMM

[POWER mnemonic: **ti**]

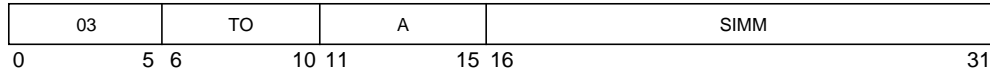

```

a ← EXTS(rA[32-63])
if (a < EXTS(SIMM)) & TO[0] then TRAP
if (a > EXTS(SIMM)) & TO[1] then TRAP
if (a = EXTS(SIMM)) & TO[2] then TRAP
if (a <U EXTS(SIMM)) & TO[3] then TRAP
if (a >U EXTS(SIMM)) & TO[4] then TRAP

```

The contents of the low-order 32 bits of **rA** are compared with the sign-extended value of the **SIMM** field. If any bit in the **TO** field is set and its corresponding condition is met by the result of the comparison, then the system trap handler is invoked.

Other registers altered:

- None

Simplified mnemonics:

twgti rA,value	equivalent to	twi 8,rA,value
twllel rA,value	equivalent to	twi 6,rA,value

PowerPC Architecture Level	Supervisor Level	32-Bit	64-Bit	64-Bit Bridge	Optional	Form
----------------------------	------------------	--------	--------	---------------	----------	------

UISA						D
------	--	--	--	--	--	---

xor_x

XOR

xor_x

xor **rA,rS,rB** (**Rc = 0**)

xor. **rA,rS,rB** (**Rc = 1**)

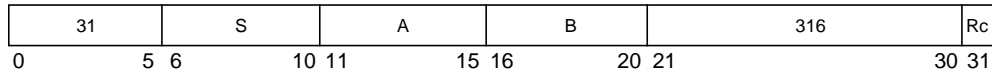

$$rA \leftarrow (rS) \oplus (rB)$$

The contents of **rS** is XORED with the contents of **rB** and the result is placed into **rA**.

Other registers altered:

- Condition Register (CR0 field):
Affected: LT, GT, EQ, SO (if **Rc = 1**)

PowerPC Architecture Level	Supervisor Level	32-Bit	64-Bit	64-Bit Bridge	Optional	Form
UISA						X

xori

XOR Immediate

xori

xori **rA,rS,UIMM**

[POWER mnemonic: **xoril**]

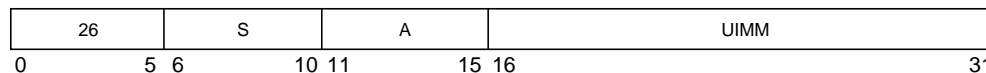

$$rA \leftarrow (rS) \oplus ((48)0 \parallel UIMM)$$

The contents of **rS** are XORed with 0x0000_0000_0000 || UIMM and the result is placed into **rA**.

Other registers altered:

- None

PowerPC Architecture Level	Supervisor Level	32-Bit	64-Bit	64-Bit Bridge	Optional	Form
UIA						D

xoris

XOR Immediate Shifted

xoris

xoris **rA,rS,UIMM**

[POWER mnemonic: **xoriu**]

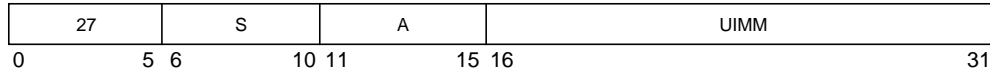

$$rA \leftarrow (rS) \oplus ((32)0 \parallel UIMM \parallel (16)0)$$

The contents of **rS** are XORed with 0x0000_0000 || UIMM || 0x0000 and the result is placed into **rA**.

Other registers altered:

- None

PowerPC Architecture Level	Supervisor Level	32-Bit	64-Bit	64-Bit Bridge	Optional	Form
----------------------------	------------------	--------	--------	---------------	----------	------

UISA						D
------	--	--	--	--	--	---

Appendix A

PowerPC Instruction Set Listings

This appendix lists the PowerPC architecture’s instruction set. Instructions are sorted by mnemonic, opcode, function, and form. Also included in this appendix is a quick reference table that contains general information, such as the architecture level, privilege level, and form, and indicates if the instruction is 64-bit and/or optional.

Note that split fields, which represent the concatenation of sequences from left to right, are shown in lowercase. For more information refer to Chapter 8, “Instruction Set.”

A.1 Instructions Sorted by Mnemonic

Table A-1 lists the instructions implemented in the PowerPC architecture in alphabetical order by mnemonic.

Key:

 Reserved bits

Table A-1. Complete Instruction List Sorted by Mnemonic

Name	0	6	7	8	9	10	11	12	13	14	15	16	17	18	19	20	21	22	23	24	25	26	27	28	29	30	31	
addx	31		D			A							B		OE													Rc
addcx	31		D			A							B		OE													Rc
addex	31		D			A							B		OE													Rc
addi	14		D			A							SIMM															
addic	12		D			A							SIMM															
addic.	13		D			A							SIMM															
addis	15		D			A							SIMM															
addmex	31		D			A						0	0	0	0	0		OE										Rc
addzex	31		D			A						0	0	0	0	0		OE										Rc
andx	31		S			A							B															Rc
andcx	31		S			A							B															Rc
andi.	28		S			A							UIMM															

Name 0 6 7 8 9 10 11 12 13 14 15 16 17 18 19 20 21 22 23 24 25 26 27 28 29 30 31

andis.	29	S			A			UIMM					
bx	18	LI										AA	LK
bcx	16	BO			BI			BD				AA	LK
bcctrx	19	BO			BI			0 0 0 0 0		528			LK
bclrx	19	BO			BI			0 0 0 0 0		16			LK
cmp	31	crfD	0	L	A			B		0			0
cmpi	11	crfD	0	L	A			SIMM					
cmpl	31	crfD	0	L	A			B		32			0
cmpli	10	crfD	0	L	A			UIMM					
cntlzdx¹	31	S			A			0 0 0 0 0		58			Rc
cntlzwx	31	S			A			0 0 0 0 0		26			Rc
crand	19	crbD			crbA			crbB		257			0
crandc	19	crbD			crbA			crbB		129			0
creqv	19	crbD			crbA			crbB		289			0
crnand	19	crbD			crbA			crbB		225			0
crnor	19	crbD			crbA			crbB		33			0
cror	19	crbD			crbA			crbB		449			0
crorc	19	crbD			crbA			crbB		417			0
crxor	19	crbD			crbA			crbB		193			0
dcba²	31	0 0 0 0 0			A			B		758			0
dcbf	31	0 0 0 0 0			A			B		86			0
dcbi³	31	0 0 0 0 0			A			B		470			0
dcbst	31	0 0 0 0 0			A			B		54			0
dcbt	31	0 0 0 0 0			A			B		278			0
dcbstst	31	0 0 0 0 0			A			B		246			0
dcbz	31	0 0 0 0 0			A			B		1014			0
divdx¹	31	D			A			B		OE	489		Rc
divdux¹	31	D			A			B		OE	457		Rc
divwx	31	D			A			B		OE	491		Rc
divwux	31	D			A			B		OE	459		Rc
eciwx	31	D			A			B		310			0
ecowx	31	S			A			B		438			0
eieio	31	0 0 0 0 0			0 0 0 0 0			0 0 0 0 0		854			0

Name 0 6 7 8 9 10 11 12 13 14 15 16 17 18 19 20 21 22 23 24 25 26 27 28 29 30 31

eqvx	31	S	A	B	284	Rc	
extsbx	31	S	A	0 0 0 0 0	954	Rc	
extshx	31	S	A	0 0 0 0 0	922	Rc	
extswx¹	31	S	A	0 0 0 0 0	986	Rc	
fabsx	63	D	0 0 0 0 0	B	264	Rc	
faddx	63	D	A	B	0 0 0 0 0	21	Rc
faddsx	59	D	A	B	0 0 0 0 0	21	Rc
fcfidx¹	63	D	0 0 0 0 0	B	846	Rc	
fcmppo	63	crfD	0 0	A	B	32	0
fcmпу	63	crfD	0 0	A	B	0	0
fctidx¹	63	D	0 0 0 0 0	B	814	Rc	
fctidzx¹	63	D	0 0 0 0 0	B	815	Rc	
fctiw^x	63	D	0 0 0 0 0	B	14	Rc	
fctiwzx	63	D	0 0 0 0 0	B	15	Rc	
fdivx	63	D	A	B	0 0 0 0 0	18	Rc
fdivsx	59	D	A	B	0 0 0 0 0	18	Rc
fmaddx	63	D	A	B	C	29	Rc
fmaddsx	59	D	A	B	C	29	Rc
fmr^x	63	D	0 0 0 0 0	B	72	Rc	
fmsubx	63	D	A	B	C	28	Rc
fmsubsx	59	D	A	B	C	28	Rc
fmulx	63	D	A	0 0 0 0 0	C	25	Rc
fmulsx	59	D	A	0 0 0 0 0	C	25	Rc
fnabsx	63	D	0 0 0 0 0	B	136	Rc	
fnegx	63	D	0 0 0 0 0	B	40	Rc	
fnmaddx	63	D	A	B	C	31	Rc
fnmaddsx	59	D	A	B	C	31	Rc
fnmsubx	63	D	A	B	C	30	Rc
fnmsubsx	59	D	A	B	C	30	Rc
fresx²	59	D	0 0 0 0 0	B	0 0 0 0 0	24	Rc
frsp^x	63	D	0 0 0 0 0	B	12	Rc	
frsqrtex²	63	D	0 0 0 0 0	B	0 0 0 0 0	26	Rc
fselx²	63	D	A	B	C	23	Rc

Name 0 6 7 8 9 10 11 12 13 14 15 16 17 18 19 20 21 22 23 24 25 26 27 28 29 30 31

fsqrtx²	63	D	0 0 0 0 0	B	0 0 0 0 0	22	Rc	
fsqrtsx²	59	D	0 0 0 0 0	B	0 0 0 0 0	22	Rc	
fsubx	63	D	A	B	0 0 0 0 0	20	Rc	
fsubsx	59	D	A	B	0 0 0 0 0	20	Rc	
icbi	31	0 0 0 0 0	A	B	982		0	
isync	19	0 0 0 0 0	0 0 0 0 0	0 0 0 0 0	150		0	
lbz	34	D	A	d				
lbzu	35	D	A	d				
lbzux	31	D	A	B	119		0	
lbzx	31	D	A	B	87		0	
ld¹	58	D	A	ds				0
ldarx¹	31	D	A	B	84		0	
ldu¹	58	D	A	ds				1
ldux¹	31	D	A	B	53		0	
ldx¹	31	D	A	B	21		0	
lfd	50	D	A	d				
lfdx	51	D	A	d				
lfdx	31	D	A	B	631		0	
lfdx	31	D	A	B	599		0	
lfs	48	D	A	d				
lfsu	49	D	A	d				
lfsux	31	D	A	B	567		0	
lfsx	31	D	A	B	535		0	
lha	42	D	A	d				
lhau	43	D	A	d				
lhax	31	D	A	B	375		0	
lhax	31	D	A	B	343		0	
lhbrx	31	D	A	B	790		0	
lhz	40	D	A	d				
lhzu	41	D	A	d				
lhzux	31	D	A	B	311		0	
lhzx	31	D	A	B	279		0	
lmw⁴	46	D	A	d				

Name	0	6	7	8	9	10	11	12	13	14	15	16	17	18	19	20	21	22	23	24	25	26	27	28	29	30	31		
lswi ⁴	31		D				A							NB													597	0	
lswx ⁴	31		D				A							B														533	0
lwa ¹	58		D				A																				ds	2	
lwarx	31		D				A							B														20	0
lwaux ¹	31		D				A							B														373	0
lwax ¹	31		D				A							B														341	0
lwbrx	31		D				A							B														534	0
lwz	32		D				A																					d	
lwzu	33		D				A																					d	
lwzux	31		D				A							B														55	0
lwzx	31		D				A							B														23	0
mcrf	19		crfD		00		crfS		00					00000														0	0
mcrfs	63		crfD		00		crfS		00					00000														64	0
mcrxr	31		crfD		00		00000							00000														512	0
mfcrr	31		D				00000							00000														19	0
mffsx	63		D				00000							00000														583	Rc
mfmsr ³	31		D				00000							00000														83	0
mfmspr ⁵	31		D											spr														339	0
mfmsr ^{3,6}	31		D		0		SR							00000														595	0
mfmsrin ^{3,6}	31		D				00000							B														659	0
mftb	31		D											tbr														371	0
mtrcf	31		S		0									CRM		0												144	0
mtfsb0x	63		crbD				00000							00000														70	Rc
mtfsb1x	63		crbD				00000							00000														38	Rc
mtfsfx	63		0				FM		0					B														711	Rc
mtfsfix	63		crfD		00		00000							IMM		0												134	Rc
mtmsr ^{3,6}	31		S				00000							00000														146	0
mtmsrd ^{1,3}	31		S				00000							00000														178	0
mtmspr ⁵	31		S											spr														467	0
mtmsr ^{3,6}	31		S		0		SR							00000														210	0
mtmsrd ^{3,6}	31		S		0		SR							00000														82	0
mtmsrdin ^{3,6}	31		S				00000							B														114	0
mtmsrin ^{3,6}	31		S				00000							B														242	0

Name	0	6	7	8	9	10	11	12	13	14	15	16	17	18	19	20	21	22	23	24	25	26	27	28	29	30	31	
mulhdx ¹	31		D			A								B		0												Rc
mulhdux ¹	31		D			A								B		0												Rc
mulhwx	31		D			A								B		0												Rc
mulhwux	31		D			A								B		0												Rc
mulldx ¹	31		D			A								B		OE												Rc
mulli	7		D			A												SIMM										
mullwx	31		D			A								B		OE												Rc
nandx	31		S			A								B														Rc
negx	31		D			A							0 0 0 0 0			OE												Rc
norx	31		S			A								B														Rc
orx	31		S			A								B														Rc
orcx	31		S			A								B														Rc
ori	24		S			A												UIMM										
oris	25		S			A												UIMM										
rfi ^{3,6}	19			0 0 0 0 0			0 0 0 0 0							0 0 0 0 0														0
rfd ^{1,3}	19			0 0 0 0 0			0 0 0 0 0							0 0 0 0 0														0
rdclx ¹	30		S			A								B							mb			8			Rc	
rdcrx ¹	30		S			A								B								me		9			Rc	
rdicx ¹	30		S			A								sh								mb		2	sh		Rc	
rdicl_x ¹	30		S			A								sh								mb		0	sh		Rc	
rdicr_x ¹	30		S			A								sh									me		1	sh	Rc	
rdimix ¹	30		S			A								sh									mb		3	sh	Rc	
rwimix	20		S			A								SH								MB		ME			Rc	
rlwinmx	21		S			A								SH									MB		ME		Rc	
rlwnmx	23		S			A								B									MB		ME		Rc	
sc	17			0 0 0 0 0			0 0 0 0 0											0 0 0 0 0 0 0 0 0 0 0 0 0 0 0 0 0 0								1	0	
slbia ^{1,2,3}	31			0 0 0 0 0			0 0 0 0 0							0 0 0 0 0														0
slbie ^{1,2,3}	31			0 0 0 0 0			0 0 0 0 0							B														0
sldx ¹	31		S			A								B														Rc
slwx	31		S			A								B														Rc
sradx ¹	31		S			A								B														Rc
sradix ¹	31		S			A								sh											413	sh	Rc	
srawx	31		S			A								B														Rc

Name 0 6 7 8 9 10 11 12 13 14 15 16 17 18 19 20 21 22 23 24 25 26 27 28 29 30 31

srawix	31	S	A	SH	824	Rc
srdx ¹	31	S	A	B	539	Rc
srwx	31	S	A	B	536	Rc
stb	38	S	A	d		
stbu	39	S	A	d		
stbux	31	S	A	B	247	0
stbx	31	S	A	B	215	0
std ¹	62	S	A	ds		0
stdcx ¹	31	S	A	B	214	1
stdu ¹	62	S	A	ds		1
stdux ¹	31	S	A	B	181	0
stdx ¹	31	S	A	B	149	0
stfd	54	S	A	d		
stfdu	55	S	A	d		
stfdux	31	S	A	B	759	0
stfdx	31	S	A	B	727	0
stfiwx ²	31	S	A	B	983	0
stfs	52	S	A	d		
stfsu	53	S	A	d		
stfsux	31	S	A	B	695	0
stfsx	31	S	A	B	663	0
sth	44	S	A	d		
sthbrx	31	S	A	B	918	0
sthu	45	S	A	d		
sthux	31	S	A	B	439	0
sthx	31	S	A	B	407	0
stmw ⁴	47	S	A	d		
stswi ⁴	31	S	A	NB	725	0
stswx ⁴	31	S	A	B	661	0
stw	36	S	A	d		
stwbrx	31	S	A	B	662	0
stwcx	31	S	A	B	150	1
stwu	37	S	A	d		

Name	0	6	7	8	9	10	11	12	13	14	15	16	17	18	19	20	21	22	23	24	25	26	27	28	29	30	31			
stwux	31		S				A							B													183	0		
stw	31		S				A							B														151	0	
subfx	31		D				A							B		OE												40	Rc	
subfcx	31		D				A							B		OE												8	Rc	
subfex	31		D				A							B		OE												136	Rc	
subfic	08		D				A																						SIMM	
subfmex	31		D				A					0 0 0 0 0				OE												232	Rc	
subfzex	31		D				A					0 0 0 0 0				OE												200	Rc	
sync	31			0 0 0 0 0			0 0 0 0 0					0 0 0 0 0																598	0	
td ¹	31		TO				A							B														68	0	
tdi ¹	02		TO				A																							SIMM
tlbia ^{2,3}	31			0 0 0 0 0			0 0 0 0 0					0 0 0 0 0																370	0	
tlbie ^{2,3}	31			0 0 0 0 0			0 0 0 0 0							B														306	0	
tlbsync ^{2,3}	31			0 0 0 0 0			0 0 0 0 0					0 0 0 0 0																566	0	
tw	31		TO				A							B														4	0	
twi	03		TO				A																							SIMM
xorx	31		S				A							B														316	Rc	
xori	26		S				A																							UIMM
xoris	27		S				A																							UIMM

Notes:

- ¹ 64-bit instruction
- ² Optional instruction
- ³ Supervisor-level instruction
- ⁴ Load/store string/multiple instruction
- ⁵ Supervisor- and user-level instruction
- ⁶ Optional 64-bit bridge instruction

A.2 Instructions Sorted by Opcode

Table A-2 lists the instructions defined in the PowerPC architecture in numeric order by opcode.

Key:

 Reserved bits

Table A-2. Complete Instruction List Sorted by Opcode

Name	0	5	6	7	8	9	10	11	12	13	14	15	16	17	18	19	20	21	22	23	24	25	26	27	28	29	30	31
tdi ¹	000010	TO			A			SIMM																				
twi	000011	TO			A			SIMM																				
mulli	000111	D			A			SIMM																				
subfic	001000	D			A			SIMM																				
cmpli	001010	crfD	0	L	A			UIMM																				
cmpi	001011	crfD	0	L	A			SIMM																				
addic	001100	D			A			SIMM																				
addic.	001101	D			A			SIMM																				
addi	001110	D			A			SIMM																				
addis	001111	D			A			SIMM																				
bcx	010000	BO			BI			BD										AA	LK									
sc	010001	00000			00000			0000000000000000										1	0									
bx	010010	LI																								AA	LK	
mcrf	010011	crfD	00	crfS	00	00000			0000000000										0									
bclrx	010011	BO			BI			00000			0000010000										LK							
rfd ^{1,2}	010011	00000			00000			00000			0000010010										0							
crnor	010011	crbD			crbA			crbB			0000100001										0							
rfi ^{2,3}	010011	00000			00000			00000			0000110010										0							
crandc	010011	crbD			crbA			crbB			0010000001										0							
isync	010011	00000			00000			00000			0010010110										0							
crxor	010011	crbD			crbA			crbB			0011000001										0							
crnand	010011	crbD			crbA			crbB			0011100001										0							
crand	010011	crbD			crbA			crbB			0100000001										0							
creqv	010011	crbD			crbA			crbB			0100100001										0							
crorc	010011	crbD			crbA			crbB			0110100001										0							
cror	010011	crbD			crbA			crbB			0111000001										0							

Name 0 5 6 7 8 9 10 11 12 13 14 15 16 17 18 19 20 21 22 23 24 25 26 27 28 29 30 31

bcctrx	010011	BO	BI	00000	1000010000	LK
rlwimix	010100	S	A	SH	MB ME	Rc
rlwinmx	010101	S	A	SH	MB ME	Rc
rlwnmx	010111	S	A	B	MB ME	Rc
ori	011000	S	A	UIMM		
oris	011001	S	A	UIMM		
xori	011010	S	A	UIMM		
xoris	011011	S	A	UIMM		
andi.	011100	S	A	UIMM		
andis.	011101	S	A	UIMM		
rldicl ¹	011110	S	A	sh	mb 000	sh Rc
rldicr ¹	011110	S	A	sh	me 001	sh Rc
rldicx ¹	011110	S	A	sh	mb 010	sh Rc
rldimix ¹	011110	S	A	sh	mb 011	sh Rc
rldclx ¹	011110	S	A	B	mb 01000	Rc
rldcrx ¹	011110	S	A	B	me 01001	Rc
cmp	011111	crfD 0 L	A	B	0000000000	0
tw	011111	TO	A	B	0000000100	0
subfcx	011111	D	A	B OE	0000001000	Rc
mulhd ¹	011111	D	A	B 0	0000001001	Rc
addcx	011111	D	A	B OE	0000001010	Rc
mulhw ¹	011111	D	A	B 0	0000001011	Rc
mfc ¹	011111	D	00000	00000	0000010011	0
lwarx	011111	D	A	B	0000010100	0
ldx ¹	011111	D	A	B	0000010101	0
lwzx	011111	D	A	B	0000010111	0
slwx	011111	S	A	B	0000011000	Rc
cntlzwx	011111	S	A	00000	0000011010	Rc
sldx ¹	011111	S	A	B	0000011011	Rc
andx	011111	S	A	B	0000011100	Rc
cmpl	011111	crfD 0 L	A	B	0000100000	0
subfx	011111	D	A	B OE	0000101000	Rc
ldux ¹	011111	D	A	B	0000110101	0

Name	0	5	6	7	8	9	10	11	12	13	14	15	16	17	18	19	20	21	22	23	24	25	26	27	28	29	30	31	
dcbst	011111	00000							A					B														0	
lwzux	011111		D						A					B															0
cntlzdx ¹	011111		S						A				00000																Rc
andcx	011111		S						A					B															Rc
td ¹	011111		TO						A					B															0
mulhdx ¹	011111		D						A					B			0												Rc
mulhwx	011111		D						A					B			0												Rc
mtsr ^{2,3}	011111		S			0			SR				00000																0
mfmsr ²	011111		D					00000					00000																0
ldarx ¹	011111		D						A					B															0
dcbf	011111	00000							A					B															0
lbzx	011111		D						A					B															0
negx	011111		D						A				00000					OE											Rc
mtsr ^{2,3}	011111		S					00000						B															0
lbzux	011111		D						A					B															0
norx	011111		S						A					B															Rc
subfex	011111		D						A					B				OE											Rc
addex	011111		D						A					B				OE											Rc
mtcrf	011111		S			0							CRM				0												0
mtmsr ^{2,3}	011111		S					00000					00000																0
stdx ¹	011111		S						A					B															0
stwcx.	011111		S						A					B															1
stwx	011111		S						A					B															0
mtmsrd ^{1,2}	011111		S					00000					00000																0
stdux ¹	011111		S						A					B															0
stwux	011111		S						A					B															0
subfzex	011111		D						A				00000					OE											Rc
addzex	011111		D						A				00000					OE											Rc
mtsr ^{2,3}	011111		S			0			SR				00000																0
stdcx. ¹	011111		S						A					B															1
stbx	011111		S						A					B															0
subfmex	011111		D						A				00000					OE											Rc
mulld ¹	011111		D						A					B				OE											Rc

Name	0	5	6	7	8	9	10	11	12	13	14	15	16	17	18	19	20	21	22	23	24	25	26	27	28	29	30	31
addmex	011111	D								A			00000	OE							0011101010							Rc
mullwx	011111	D								A				B	OE						0011101011							Rc
mtsrin ^{2,3}	011111	S						00000						B							0011110010							0
dcbst	011111		00000							A				B							0011110110							0
stbux	011111	S								A				B							0011110111							0
addx	011111	D								A				B	OE						0100001010							Rc
dcbt	011111		00000							A				B							0100010110							0
lhzx	011111	D								A				B							0100010111							0
eqvx	011111	S								A				B							0100011100							Rc
tlbie ^{2,4}	011111		00000				00000							B							0100110010							0
eciwx	011111	D								A				B							0100110110							0
lhux	011111	D								A				B							0100110111							0
xorx	011111	S								A				B							0100111100							Rc
mfspr ⁵	011111	D											spr								0101010011							0
lwax ¹	011111	D								A				B							0101010101							0
lhax	011111	D								A				B							0101010111							0
tlbia ^{2,4}	011111		00000				00000						00000								0101110010							0
mftb	011111	D											tbr								0101110011							0
lwaux ¹	011111	D								A				B							0101110101							0
lhaux	011111	D								A				B							0101110111							0
sthx	011111	S								A				B							0110010111							0
orcx	011111	S								A				B							0110011100							Rc
sradix ¹	011111	S								A				sh							1100111011		sh					Rc
slbie ^{1,2,4}	011111		00000				00000							B							0110110010							0
ecowx	011111	S								A				B							0110110110							0
sthux	011111	S								A				B							0110110111							0
orx	011111	S								A				B							0110111100							Rc
divdux ¹	011111	D								A				B	OE						0111001001							Rc
divwux	011111	D								A				B	OE						0111001011							Rc
mtspr ⁵	011111	S											spr								0111010011							0
dcbi ²	011111		00000							A				B							0111010110							0
nandx	011111	S								A				B							0111011100							Rc
divdx ¹	011111	D								A				B	OE						0111101001							Rc

Name	0	5	6	7	8	9	10	11	12	13	14	15	16	17	18	19	20	21	22	23	24	25	26	27	28	29	30	31
divw_x	011111	D			A			B			OE	0111101011						Rc										
slbia^{1,2,4}	011111	00000			00000			00000			0111110010						0											
mcrxr	011111	crfD	00		00000			00000			1000000000						0											
lsw_x⁶	011111	D			A			B			1000010101						0											
lwb_x	011111	D			A			B			1000010110						0											
lfs_x	011111	D			A			B			1000010111						0											
srw_x	011111	S			A			B			1000011000						Rc											
srdx¹	011111	S			A			B			1000011011						Rc											
tlbsync^{2,4}	011111	00000			00000			00000			1000110110						0											
lfsu_x	011111	D			A			B			1000110111						0											
mfsr^{2,3}	011111	D			0	SR		00000			1001010011						0											
lswi⁶	011111	D			A			NB			1001010101						0											
sync	011111	00000			00000			00000			1001010110						0											
lfd_x	011111	D			A			B			1001010111						0											
lfdu_x	011111	D			A			B			1001110111						0											
mfsrin^{2,3}	011111	D			00000			B			1010010011						0											
stsw_x⁶	011111	S			A			B			1010010101						0											
stw_{brx}	011111	S			A			B			1010010110						0											
stfs_x	011111	S			A			B			1010010111						0											
stfsu_x	011111	S			A			B			1010110111						0											
stswi⁶	011111	S			A			NB			1011010101						0											
stfd_x	011111	S			A			B			1011010111						0											
dcba⁴	31	00000			A			B			1011110110						0											
stfdu_x	011111	S			A			B			1011110111						0											
lhbr_x	011111	D			A			B			1100010110						0											
sraw_x	011111	S			A			B			1100011000						Rc											
sradx¹	011111	S			A			B			1100011010						Rc											
srawi_x	011111	S			A			SH			1100111000						Rc											
eieio	011111	00000			00000			00000			1101010110						0											
sthbr_x	011111	S			A			B			1110010110						0											
extsh_x	011111	S			A			00000			1110011010						Rc											
extsb_x	011111	S			A			00000			1110111010						Rc											
icbi	011111	00000			A			B			1111010110						0											

Name	0	5	6	7	8	9	10	11	12	13	14	15	16	17	18	19	20	21	22	23	24	25	26	27	28	29	30	31	
stfiwx ⁴	0111111	S								A																			0
extsw ¹	0111111	S								A				00000															Rc
dcbz	0111111		00000							A																			0
lwz	100000	D								A																			
lwzu	100001	D								A																			
lbz	100010	D								A																			
lbzu	100011	D								A																			
stw	100100	S								A																			
stwu	100101	S								A																			
stb	100110	S								A																			
stbu	100111	S								A																			
lhz	101000	D								A																			
lhzu	101001	D								A																			
lha	101010	D								A																			
lhau	101011	D								A																			
sth	101100	S								A																			
sthu	101101	S								A																			
lmw ⁶	101110	D								A																			
stmw ⁶	101111	S								A																			
lfs	110000	D								A																			
lfsu	110001	D								A																			
lfd	110010	D								A																			
lfd�	110011	D								A																			
stfs	110100	S								A																			
stfsu	110101	S								A																			
stfd	110110	S								A																			
stfdû	110111	S								A																			
ld ¹	111010	D								A																			00
ldu ¹	111010	D								A																			01
lwa ¹	111010	D								A																			10
fdivsx	111011	D								A				B								00000			10010				Rc
fsubsx	111011	D								A				B								00000			10100				Rc
faddsx	111011	D								A				B								00000			10101				Rc

Name	0	5	6	7	8	9	10	11	12	13	14	15	16	17	18	19	20	21	22	23	24	25	26	27	28	29	30	31
fsqrtx⁴	1 1 1 0 1 1	D						0 0 0 0 0					B						0 0 0 0 0				1 0 1 1 0					Rc
fresx⁴	1 1 1 0 1 1	D						0 0 0 0 0					B						0 0 0 0 0				1 1 0 0 0					Rc
fmulx	1 1 1 0 1 1	D						A					0 0 0 0 0						C			1 1 0 0 1					Rc	
fmsubx	1 1 1 0 1 1	D						A					B						C			1 1 1 0 0					Rc	
fmaddx	1 1 1 0 1 1	D						A					B						C			1 1 1 0 1					Rc	
fnmsubx	1 1 1 0 1 1	D						A					B						C			1 1 1 1 0					Rc	
fnmaddx	1 1 1 0 1 1	D						A					B						C			1 1 1 1 1					Rc	
std¹	1 1 1 1 1 0	S						A											ds								0 0	
stdu¹	1 1 1 1 1 0	S						A											ds								0 1	
fcmpu	1 1 1 1 1 1	crfD	0 0					A					B						0 0 0 0 0 0 0 0 0 0								0	
frspx	1 1 1 1 1 1	D						0 0 0 0 0					B						0 0 0 0 0 0 1 1 0 0								Rc	
fctiw^x	1 1 1 1 1 1	D						0 0 0 0 0					B						0 0 0 0 0 0 1 1 1 0									
fctiwz^x	1 1 1 1 1 1	D						0 0 0 0 0					B						0 0 0 0 0 0 1 1 1 1								Rc	
fdiv^x	1 1 1 1 1 1	D						A					B						0 0 0 0 0			1 0 0 1 0					Rc	
fsub^x	1 1 1 1 1 1	D						A					B						0 0 0 0 0			1 0 1 0 0					Rc	
fadd^x	1 1 1 1 1 1	D						A					B						0 0 0 0 0			1 0 1 0 1					Rc	
fsqrtx⁴	1 1 1 1 1 1	D						0 0 0 0 0					B						0 0 0 0 0			1 0 1 1 0					Rc	
fselx⁴	1 1 1 1 1 1	D						A					B						C			1 0 1 1 1					Rc	
fmul^x	1 1 1 1 1 1	D						A					0 0 0 0 0						C			1 1 0 0 1					Rc	
frsqrte¹	1 1 1 1 1 1	D						0 0 0 0 0					B						0 0 0 0 0			1 1 0 1 0					Rc	
fmsub^x	1 1 1 1 1 1	D						A					B						C			1 1 1 0 0					Rc	
fmadd^x	1 1 1 1 1 1	D						A					B						C			1 1 1 0 1					Rc	
fnmsub^x	1 1 1 1 1 1	D						A					B						C			1 1 1 1 0					Rc	
fnmadd^x	1 1 1 1 1 1	D						A					B						C			1 1 1 1 1					Rc	
fcmpo	1 1 1 1 1 1	crfD	0 0					A					B						0 0 0 0 1 0 0 0 0 0								0	
mtfsb1^x	1 1 1 1 1 1	crbD						0 0 0 0 0					0 0 0 0 0						0 0 0 0 1 0 0 1 1 0								Rc	
fneg^x	1 1 1 1 1 1	D						0 0 0 0 0					B						0 0 0 0 1 0 1 0 0 0								Rc	
mcrfs	1 1 1 1 1 1	crfD	0 0				crfS	0 0					0 0 0 0 0						0 0 0 1 0 0 0 0 0 0								0	
mtfsb0^x	1 1 1 1 1 1	crbD						0 0 0 0 0					0 0 0 0 0						0 0 0 1 0 0 0 1 1 0								Rc	
fmr^x	1 1 1 1 1 1	D						0 0 0 0 0					B						0 0 0 1 0 0 1 0 0 0								Rc	
mtfsfix	1 1 1 1 1 1	crfD	0 0					0 0 0 0 0					IMM	0					0 0 1 0 0 0 0 1 1 0								Rc	
fnabs^x	1 1 1 1 1 1	D						0 0 0 0 0					B						0 0 1 0 0 0 1 0 0 0								Rc	
fabs^x	1 1 1 1 1 1	D						0 0 0 0 0					B						0 1 0 0 0 0 1 0 0 0								Rc	

Name 0 5 6 7 8 9 10 11 12 13 14 15 16 17 18 19 20 21 22 23 24 25 26 27 28 29 30 31

mfsx	1 1 1 1 1 1 1	D	0 0 0 0 0	0 0 0 0 0	1 0 0 1 0 0 0 1 1 1	Rc	
mtfsx	1 1 1 1 1 1 1	0	FM	0	B	1 0 1 1 0 0 0 1 1 1	Rc
fctidx ¹	1 1 1 1 1 1 1	D	0 0 0 0 0	B	1 1 0 0 1 0 1 1 1 0	Rc	
fctidz ¹	1 1 1 1 1 1 1	D	0 0 0 0 0	B	1 1 0 0 1 0 1 1 1 1	Rc	
fcfidz ¹	1 1 1 1 1 1 1	D	0 0 0 0 0	B	1 1 0 1 0 0 1 1 1 0	Rc	

Notes:

- ¹ 64-bit instruction
- ² Supervisor-level instruction
- ³ Optional 64-bit bridge instruction
- ⁴ Optional instruction
- ⁵ Supervisor- and user-level instruction
- ⁶ Load/store string/multiple instruction

A.3 Instructions Grouped by Functional Categories

Table A-3 through Table A-30 list the PowerPC instructions grouped by function.

Key:  Reserved bits

Table A-3. Integer Arithmetic Instructions

Name	0	5	6	7	8	9	10	11	12	13	14	15	16	17	18	19	20	21	22	23	24	25	26	27	28	29	30	31
addx	31		D						A									B	OE				266				Rc	
addcx	31		D						A									B	OE				10				Rc	
addex	31		D						A									B	OE				138				Rc	
addi	14		D						A														SIMM					
addic	12		D						A														SIMM					
addic.	13		D						A														SIMM					
addis	15		D						A														SIMM					
addmex	31		D						A				0	0	0	0	0		OE				234				Rc	
addzex	31		D						A				0	0	0	0	0		OE				202				Rc	
divdx ¹	31		D						A									B	OE				489				Rc	
divdux ¹	31		D						A									B	OE				457				Rc	
divwx	31		D						A									B	OE				491				Rc	
divwux	31		D						A									B	OE				459				Rc	
mulhd ¹	31		D						A									B	0				73				Rc	
mulhd ¹	31		D						A									B	0				9				Rc	
mulhw	31		D						A									B	0				75				Rc	
mulhw	31		D						A									B	0				11				Rc	
mulld ¹	31		D						A									B	OE				233				Rc	
mulli	07		D						A														SIMM					
mullw	31		D						A									B	OE				235				Rc	
negx	31		D						A				0	0	0	0	0		OE				104				Rc	
subfx	31		D						A									B	OE				40				Rc	
subfcx	31		D						A									B	OE				8				Rc	
subficx	08		D						A														SIMM					
subfex	31		D						A									B	OE				136				Rc	
subfmex	31		D						A				0	0	0	0	0		OE				232				Rc	
subfzex	31		D						A				0	0	0	0	0		OE				200				Rc	

Note:
¹ 64-bit instruction

Table A-4. Integer Compare Instructions

Name	0	5	6	7	8	9	10	11	12	13	14	15	16	17	18	19	20	21	22	23	24	25	26	27	28	29	30	31
cmp	31	crfD	0	L		A		B	000000000000										0									
cmpi	11	crfD	0	L		A	SIMM																					
cmpl	31	crfD	0	L		A		B	32										0									
cmpli	10	crfD	0	L		A	UIMM																					

Table A-5. Integer Logical Instructions

Name	0	5	6	7	8	9	10	11	12	13	14	15	16	17	18	19	20	21	22	23	24	25	26	27	28	29	30	31
andx	31		S			A		B	28										Rc									
andcx	31		S			A		B	60										Rc									
andi	28		S			A	UIMM																					
andis	29		S			A	UIMM																					
cntlzdx ¹	31		S			A	00000	58										Rc										
cntlzwx	31		S			A	00000	26										Rc										
eqvx	31		S			A		B	284										Rc									
extsbx	31		S			A	00000	954										Rc										
extshx	31		S			A	00000	922										Rc										
extswx ¹	31		S			A	00000	986										Rc										
nandx	31		S			A		B	476										Rc									
norx	31		S			A		B	124										Rc									
orx	31		S			A		B	444										Rc									
orcx	31		S			A		B	412										Rc									
ori	24		S			A	UIMM																					
oris	25		S			A	UIMM																					
xorx	31		S			A		B	316										Rc									
xori	26		S			A	UIMM																					
xoris	27		S			A	UIMM																					

Note:
¹ 64-bit instruction

Table A-6. Integer Rotate Instructions

Name	0	5	6	7	8	9	10	11	12	13	14	15	16	17	18	19	20	21	22	23	24	25	26	27	28	29	30	31
rldclx ¹	30		S						A						B					mb				8				Rc
rldcrx ¹	30		S						A						B					me				9				Rc
rldicx ¹	30		S						A						sh					mb			2		sh			Rc
rldicl ¹	30		S						A						sh					mb			0		sh			Rc
rldicr ¹	30		S						A						sh					me			1		sh			Rc
rldimix ¹	30		S						A						sh					mb			3		sh			Rc
rlwimx	22		S						A						SH					MB					ME			Rc
rlwinmx	20		S						A						SH					MB					ME			Rc
rlwnmx	21		S						A						SH					MB					ME			Rc

Note:
¹ 64-bit instruction

Table A-7. Integer Shift Instructions

Name	0	5	6	7	8	9	10	11	12	13	14	15	16	17	18	19	20	21	22	23	24	25	26	27	28	29	30	31	
sldx ¹	31		S						A						B														Rc
slwx	31		S						A						B														Rc
sradx ¹	31		S						A						B														Rc
sradix ¹	31		S						A						sh														Rc
srawx	31		S						A						B														Rc
srawix	31		S						A						SH														Rc
srdx ¹	31		S						A						B														Rc
srwx	31		S						A						B														Rc

Note:
¹ 64-bit instruction

Table A-8. Floating-Point Arithmetic Instructions

Name	0	5	6	7	8	9	10	11	12	13	14	15	16	17	18	19	20	21	22	23	24	25	26	27	28	29	30	31
faddx	63		D							A					B				00000					21				Rc
faddsx	59		D							A					B				00000					21				Rc
fdivx	63		D							A					B				00000					18				Rc
fdivsx	59		D							A					B				00000					18				Rc
fmulx	63		D							A			00000						C					25				Rc
fmulsx	59		D							A			00000						C					25				Rc
fresx¹	59		D				00000								B				00000					24				Rc
frsqrtox¹	63		D				00000								B				00000					26				Rc
fsubx	63		D							A					B				00000					20				Rc
fsubsx	59		D							A					B				00000					20				Rc
fselx¹	63		D							A					B				C					23				Rc
fsqrtx¹	63		D				00000								B				00000					22				Rc
fsqrtsx¹	59		D				00000								B				00000					22				Rc

Note:

¹ Optional instruction

Table A-9. Floating-Point Multiply-Add Instructions

Name	0	5	6	7	8	9	10	11	12	13	14	15	16	17	18	19	20	21	22	23	24	25	26	27	28	29	30	31
fmaddx	63		D							A					B				C						29			Rc
fmaddsx	59		D							A					B				C						29			Rc
fmsubx	63		D							A					B				C						28			Rc
fmsubsx	59		D							A					B				C						28			Rc
fnmaddx	63		D							A					B				C						31			Rc
fnmaddsx	59		D							A					B				C						31			Rc
fnmsubx	63		D							A					B				C						30			Rc
fnmsubsx	59		D							A					B				C						30			Rc

Table A-10. Floating-Point Rounding and Conversion Instructions

Name	0	5	6	7	8	9	10	11	12	13	14	15	16	17	18	19	20	21	22	23	24	25	26	27	28	29	30	31	
fctid¹	63								0	0	0	0			B														Rc
fctid¹	63								0	0	0	0			B														Rc
fctidz¹	63								0	0	0	0			B														Rc
fctiw¹	63								0	0	0	0			B														Rc
fctiwz¹	63								0	0	0	0			B														Rc
frsp¹	63								0	0	0	0			B														Rc

Note:

¹ 64-bit instruction

Table A-11. Floating-Point Compare Instructions

Name	0	5	6	7	8	9	10	11	12	13	14	15	16	17	18	19	20	21	22	23	24	25	26	27	28	29	30	31	
fcmpo	63		crfD			0	0				A				B														0
fcmpu	63		crfD			0	0				A				B														0

Table A-12. Floating-Point Status and Control Register Instructions

Name	0	5	6	7	8	9	10	11	12	13	14	15	16	17	18	19	20	21	22	23	24	25	26	27	28	29	30	31	
mcrfs	63		crfD			0	0		crfS		0	0			0	0	0	0	0	0									0
mffsx	63								D		0	0	0	0	0	0													Rc
mtfsb0x	63								crbD		0	0	0	0	0														Rc
mtfsb1x	63								crbD		0	0	0	0	0														Rc
mtfsfx	31		0						FM				0																Rc
mtfsfix	63								crfD		0	0			0	0	0	0	0										Rc

Table A-13. Integer Load Instructions

Name	0	5	6	7	8	9	10	11	12	13	14	15	16	17	18	19	20	21	22	23	24	25	26	27	28	29	30	31	
lbz	34				D					A																			
lbzu	35				D					A																			
lbzux	31				D					A				B								119						0	
lbzx	31				D					A				B								87						0	
ld¹	58				D					A																		0	
ldu¹	58				D					A																		1	
ldux¹	31				D					A				B									53					0	
ldx¹	31				D					A				B									21					0	
lha	42				D					A																			
lhau	43				D					A																			
lhaux	31				D					A				B									375					0	
lhax	31				D					A				B									343					0	
lhz	40				D					A																			
lhzu	41				D					A																			
lhzux	31				D					A				B									311					0	
lhzx	31				D					A				B									279					0	
lwa¹	58				D					A																		2	
lwaux¹	31				D					A				B									373					0	
lwax¹	31				D					A				B									341					0	
lwz	32				D					A																			
lwzu	33				D					A																			
lwzux	31				D					A				B									55					0	
lwzx	31				D					A				B									23					0	

Note:
¹ 64-bit instruction

Table A-17. Integer Load and Store String Instructions

Name	0	5	6	7	8	9	10	11	12	13	14	15	16	17	18	19	20	21	22	23	24	25	26	27	28	29	30	31
lswi ¹	31		D						A						NB							597						0
lswx ¹	31		D						A						B							533						0
stswi ¹	31		S						A						NB							725						0
stswx ¹	31		S						A						B							661						0

Note:
¹ Load/store string/multiple instruction

Table A-18. Memory Synchronization Instructions

Name	0	5	6	7	8	9	10	11	12	13	14	15	16	17	18	19	20	21	22	23	24	25	26	27	28	29	30	31
eieio	31		0	0	0	0	0		0	0	0	0		0	0	0	0		0	0	0	0		854				0
isync	19		0	0	0	0	0		0	0	0	0		0	0	0	0		0	0	0	0		150				0
ldarx ¹	31		D						A						B							84						0
lwarx	31		D						A						B							20						0
stdcx ¹	31		S						A						B							214						1
stwcx	31		S						A						B							150						1
sync	31		0	0	0	0	0		0	0	0	0		0	0	0	0		0	0	0	0		598				0

Note:
¹ 64-bit instruction

Table A-19. Floating-Point Load Instructions

Name	0	5	6	7	8	9	10	11	12	13	14	15	16	17	18	19	20	21	22	23	24	25	26	27	28	29	30	31
lfd	50		D						A													d						
lfdu	51		D						A													d						
lfdx	31		D						A						B							631						0
lfdx	31		D						A						B							599						0
lfs	48		D						A													d						
lfsu	49		D						A													d						
lfsux	31		D						A						B							567						0
lfsx	31		D						A						B							535						0

Table A-23. Condition Register Logical Instructions

Name	0	5	6	7	8	9	10	11	12	13	14	15	16	17	18	19	20	21	22	23	24	25	26	27	28	29	30	31
crand	19	crbD			crbA			crbB			257						0											
crandc	19	crbD			crbA			crbB			129						0											
creqv	19	crbD			crbA			crbB			289						0											
crnand	19	crbD			crbA			crbB			225						0											
crnor	19	crbD			crbA			crbB			33						0											
cror	19	crbD			crbA			crbB			449						0											
crorc	19	crbD			crbA			crbB			417						0											
crxor	19	crbD			crbA			crbB			193						0											
mcrf	19	crfD	00	crfS	00	00000						0000000000						0										

Table A-24. System Linkage Instructions

Name	0	5	6	7	8	9	10	11	12	13	14	15	16	17	18	19	20	21	22	23	24	25	26	27	28	29	30	31
rfi ^{1,2}	19	00000			00000			00000			50						0											
rfid ^{1,3}	19	00000			00000			00000			18						0											
sc	17	00000			00000			000000000000000000												1	0							

Notes:

- ¹ Supervisor-level instruction
- ² Optional 64-bit bridge instruction
- ³ 64-bit instruction

Table A-25. Trap Instructions

Name	0	5	6	7	8	9	10	11	12	13	14	15	16	17	18	19	20	21	22	23	24	25	26	27	28	29	30	31
td ¹	31	TO	A			B			68						0													
tdi ¹	03	TO	A			SIMM																						
tw	31	TO	A			B			4						0													
twi	03	TO	A			SIMM																						

Note:

- ¹ 64-bit instruction

Table A-26. Processor Control Instructions

Name	0	5	6	7	8	9	10	11	12	13	14	15	16	17	18	19	20	21	22	23	24	25	26	27	28	29	30	31		
mcrxr	31	crfS	0	0	0	0	0	0	0	0	0	0	0	0	0	0	0	0	0	0	0	0	0	0	0	0	0	0	512	0
mfcrr	31	D	0	0	0	0	0	0	0	0	0	0	0	0	0	0	0	0	0	0	0	0	0	0	0	0	0	0	19	0
mfmsr ¹	31	D	0	0	0	0	0	0	0	0	0	0	0	0	0	0	0	0	0	0	0	0	0	0	0	0	0	0	83	0
mfmspr ²	31	D	spr													339	0													
mftb	31	D	tpr													371	0													
mtcrf	31	S	0	CRM													0	144	0											
mtmsr ^{1,3}	31	S	0	0	0	0	0	0	0	0	0	0	0	0	0	0	0	0	0	0	0	0	0	0	0	0	0	146	0	
mtmsrd ^{1,4}	31	S	0	0	0	0	0	0	0	0	0	0	0	0	0	0	0	0	0	0	0	0	0	0	0	0	0	178	0	
mtspr ²	31	D	spr													467	0													

Notes:

- ¹ Supervisor-level instruction
- ² Supervisor- and user-level instruction
- ³ Optional 64-bit bridge instruction
- ⁴ 64-bit instruction

Table A-27. Cache Management Instructions

Name	0	5	6	7	8	9	10	11	12	13	14	15	16	17	18	19	20	21	22	23	24	25	26	27	28	29	30	31
dcba ¹	31	0	0	0	0	0	0	0	0	A	B	758	0															
dcbf	31	0	0	0	0	0	0	0	0	A	B	86	0															
dcbi ²	31	0	0	0	0	0	0	0	0	A	B	470	0															
dcbst	31	0	0	0	0	0	0	0	0	A	B	54	0															
dcbt	31	0	0	0	0	0	0	0	0	A	B	278	0															
dcbtst	31	0	0	0	0	0	0	0	0	A	B	246	0															
dcbz	31	0	0	0	0	0	0	0	0	A	B	1014	0															
icbi	31	0	0	0	0	0	0	0	0	A	B	982	0															

Notes:

- ¹ Optional instruction
- ² Supervisor-level instruction

Table A-28. Segment Register Manipulation Instructions.

Name	0	5	6	7	8	9	10	11	12	13	14	15	16	17	18	19	20	21	22	23	24	25	26	27	28	29	30	31
mfsr ^{1,2}	31		D					0		SR			0	0	0	0	0						595					0
mfsrin ^{1,2}	31		D						0	0	0	0	0			B							659					0
mtsr ^{1,2}	31		S					0		SR			0	0	0	0	0						210					0
mtsrđ ^{1,2}	31		S					0		SR			0	0	0	0	0						82					0
mtsrđin ^{1,2}	31		S						0	0	0	0	0			B							114					0
mtsrin ^{1,2}	31		S						0	0	0	0	0			B							242					0

Notes:

- ¹ Supervisor-level instruction
- ² Optional 64-bit bridge instruction

Table A-29. Lookaside Buffer Management Instructions

Name	0	5	6	7	8	9	10	11	12	13	14	15	16	17	18	19	20	21	22	23	24	25	26	27	28	29	30	31
slbia ^{1,2,3}	31		0	0	0	0	0		0	0	0	0		0	0	0	0						498					0
slbie ^{1,2,3}	31		0	0	0	0	0		0	0	0	0			B								434					0
tlbia ^{1,2}	31		0	0	0	0	0		0	0	0	0		0	0	0	0						370					0
tlbie ^{1,2}	31		0	0	0	0	0		0	0	0	0			B								306					0
tlbsync ^{1,2}	31		0	0	0	0	0		0	0	0	0		0	0	0	0						566					0

Notes:

- ¹ Supervisor-level instruction
- ² Optional instruction
- ³ 64-bit instruction

Table A-30. External Control Instructions

Name	0	5	6	7	8	9	10	11	12	13	14	15	16	17	18	19	20	21	22	23	24	25	26	27	28	29	30	31
eciwx	31		D							A					B								310					0
ecowx	31		S							A					B								438					0

A.4 Instructions Sorted by Form

Table A-31 through Table A-45 list the PowerPC instructions grouped by form.

Key:

Reserved bits

Table A-31. I-Form

OPCD		LI			AA	LK
------	--	----	--	--	----	----

Specific Instruction

Name 0 5 6 7 8 9 10 11 12 13 14 15 16 17 18 19 20 21 22 23 24 25 26 27 28 29 30 31

bx	18	LI			AA	LK
----	----	----	--	--	----	----

Table A-32. B-Form

OPCD	BO	BI	BD		AA	LK
------	----	----	----	--	----	----

Specific Instruction

Name 0 5 6 7 8 9 10 11 12 13 14 15 16 17 18 19 20 21 22 23 24 25 26 27 28 29 30 31

bcx	16	BO	BI	BD	AA	LK
-----	----	----	----	----	----	----

Table A-33. SC-Form

OPCD	00000	00000	0000000000000000	1	0
------	-------	-------	------------------	---	---

Specific Instruction

Name 0 5 6 7 8 9 10 11 12 13 14 15 16 17 18 19 20 21 22 23 24 25 26 27 28 29 30 31

sc	17	00000	00000	0000000000000000	1	0
----	----	-------	-------	------------------	---	---

Table A-34. D-Form

OPCD	D	A	d
OPCD	D	A	SIMM
OPCD	S	A	d
OPCD	S	A	UIMM
OPCD	crfD	0 L	A
OPCD	crfD	0 L	A
OPCD	TO	A	SIMM

Specific Instructions

Name	0	5	6	7	8	9	10	11	12	13	14	15	16	17	18	19	20	21	22	23	24	25	26	27	28	29	30	31	
addi	14				D						A																		SIMM
addic	12				D						A																		SIMM
addic.	13				D						A																		SIMM
addis	15				D						A																		SIMM
andi.	28				S						A																		UIMM
andis.	29				S						A																		UIMM
cmpi	11			crfD		0	L				A																		SIMM
cmpli	10			crfD		0	L				A																		UIMM
lbz	34				D						A																		d
lbzu	35				D						A																		d
lfd	50				D						A																		d
lfdu	51				D						A																		d
lfs	48				D						A																		d
lfsu	49				D						A																		d
lha	42				D						A																		d
lhau	43				D						A																		d
lhz	40				D						A																		d
lhzu	41				D						A																		d
lmw ¹	46				D						A																		d
lwz	32				D						A																		d
lwzu	33				D						A																		d
mulli	7				D						A																		SIMM
ori	24				S						A																		UIMM
oris	25				S						A																		UIMM
stb	38				S						A																		d
stbu	39				S						A																		d
stfd	54				S						A																		d
stfdu	55				S						A																		d
stfs	52				S						A																		d
stfsu	53				S						A																		d
sth	44				S						A																		d
sthu	45				S						A																		d
stmw ¹	47				S						A																		d

stw	36	S	A	d
stwu	37	S	A	d
subfic	08	D	A	SIMM
tdi ²	02	TO	A	SIMM
twi	03	TO	A	SIMM
xori	26	S	A	UIMM
xoris	27	S	A	UIMM

Note:

¹ Load/store string/multiple instruction

² 64-bit instruction

Table A-35. DS-Form

OPCD	D	A	ds	XO
OPCD	S	A	ds	XO

Specific Instructions

Name	0	5	6	7	8	9	10	11	12	13	14	15	16	17	18	19	20	21	22	23	24	25	26	27	28	29	30	31	
ld ¹	58	D								A											ds								0
ldu ¹	58	D								A											ds								1
lwa ¹	58	D								A											ds								2
std ¹	62	S								A											ds								0
stdu ¹	62	S								A											ds								1

Note:

¹ 64-bit instruction

Table A-36. X-Form

OPCD	D		A	B	XO	0
OPCD	D		A	NB	XO	0
OPCD	D		0 0 0 0 0	B	XO	0
OPCD	D		0 0 0 0 0	0 0 0 0 0	XO	0
OPCD	D	0	SR	0 0 0 0 0	XO	0
OPCD	S		A	B	XO	Rc
OPCD	S		A	B	XO	1
OPCD	S		A	B	XO	0
OPCD	S		A	NB	XO	0
OPCD	S		A	0 0 0 0 0	XO	Rc

OPCD	S			00000	B		XO	0
OPCD	S			00000	00000		XO	0
OPCD	S	0		SR	00000		XO	0
OPCD	S			A	SH		XO	Rc
OPCD	crfD	0	L	A	B		XO	0
OPCD	crfD	00		A	B		XO	0
OPCD	crfD	00	crfS	00	00000		XO	0
OPCD	crfD	00		00000	00000		XO	0
OPCD	crfD	00		00000	IMM	0	XO	Rc
OPCD	TO			A	B		XO	0
OPCD	D			00000	B		XO	Rc
OPCD	D			00000	00000		XO	Rc
OPCD	crbD			00000	00000		XO	Rc
OPCD	00000			A	B		XO	0
OPCD	00000			00000	B		XO	0
OPCD	00000			00000	00000		XO	0

Specific Instructions

Name	0	5	6	7	8	9	10	11	12	13	14	15	16	17	18	19	20	21	22	23	24	25	26	27	28	29	30	31		
andx	31			S							A																	28	Rc	
andcx	31			S							A																		60	Rc
cmp	31	crfD	0	L							A																	0	0	
cmpl	31	crfD	0	L							A																	32	0	
cntlzdx ¹	31			S							A								00000									58	Rc	
cntlzwx	31			S							A								00000									26	Rc	
dcba ²	31			00000							A								B									758	0	
dcbf	31			00000							A								B									86	0	
dcbi ³	31			00000							A								B									470	0	
dcbst	31			00000							A								B									54	0	
dcbt	31			00000							A								B									278	0	
dcbtst	31			00000							A								B									246	0	
dcbz	31			00000							A								B									1014	0	
eciwx	31			D							A								B									310	0	
ecowx	31			S							A								B									438	0	
eieio	31			00000							00000								00000									854	0	

eqvx	31	S	A	B	284	Rc	
extsbx	31	S	A	0 0 0 0 0	954	Rc	
extshx	31	S	A	0 0 0 0 0	922	Rc	
extswx¹	31	S	A	0 0 0 0 0	986	Rc	
fabsx	63	D	0 0 0 0 0	B	264	Rc	
fcfidx¹	63	D	0 0 0 0 0	B	846	Rc	
fcmpto	63	crfD	0 0	A	B	32	0
fcmptu	63	crfD	0 0	A	B	0	0
fctidx¹	63	D	0 0 0 0 0	B	814	Rc	
fctidx¹	63	D	0 0 0 0 0	B	815	Rc	
fctiw¹	63	D	0 0 0 0 0	B	14	Rc	
fctiwz¹	63	D	0 0 0 0 0	B	15	Rc	
fmr¹	63	D	0 0 0 0 0	B	72	Rc	
fnabs¹	63	D	0 0 0 0 0	B	136	Rc	
fneg¹	63	D	0 0 0 0 0	B	40	Rc	
frsp¹	63	D	0 0 0 0 0	B	12	Rc	
icbi	31	0 0 0 0 0	A	B	982	0	
lbzux	31	D	A	B	119	0	
lbzx	31	D	A	B	87	0	
ldar¹	31	D	A	B	84	0	
ldux¹	31	D	A	B	53	0	
ldx¹	31	D	A	B	21	0	
lfdx	31	D	A	B	631	0	
lfdx	31	D	A	B	599	0	
lfsux	31	D	A	B	567	0	
lfsx	31	D	A	B	535	0	
lhaux	31	D	A	B	375	0	
lhax	31	D	A	B	343	0	
lhrx	31	D	A	B	790	0	
lhzux	31	D	A	B	311	0	
lhzx	31	D	A	B	279	0	
lswi⁴	31	D	A	NB	597	0	
lswx⁴	31	D	A	B	533	0	
lwarx	31	D	A	B	20	0	
lwaux¹	31	D	A	B	373	0	

lwax ¹	31	D	A	B	341	0		
lwbrx	31	D	A	B	534	0		
lwzux	31	D	A	B	55	0		
lwzx	31	D	A	B	23	0		
mcrfs	63	crfD	00	crfS	00	00000	64	0
mcrxr	31	crfD	00	00000	00000	512	0	
mfcrr	31	D	00000	00000	19	0		
mffsx	63	D	00000	00000	583	Rc		
mfmsr ³	31	D	00000	00000	83	0		
mfsr ^{3,5}	31	D	0	SR	00000	595	0	
mfsrin ^{3,5}	31	D	00000	B	659	0		
mtfsb0x	63	crbD	00000	00000	70	Rc		
mtfsb1x	63	crfD	00000	00000	38	Rc		
mtfsfix	63	crbD	00	00000	IMM	0	134	Rc
mtmsr ^{3,5}	31	S	00000	00000	146	0		
mtmsrd ^{1,3}	31	S	00000	00000	178	0		
mtsr ^{3,5}	31	S	0	SR	00000	210	0	
mtsrdr ^{3,5}	31	S	0	SR	00000	82	0	
mtsrin ^{3,5}	31	S	00000	B	242	0		
mtsrdrin ^{3,5}	31	S	00000	B	114	0		
nandx	31	S	A	B	476	Rc		
norx	31	S	A	B	124	Rc		
orx	31	S	A	B	444	Rc		
orcx	31	S	A	B	412	Rc		
slbia ^{1,2,3}	31	00000	00000	00000	498	0		
slbie ^{1,2,3}	31	00000	00000	B	434	0		
sldx ¹	31	S	A	B	27	Rc		
slwx	31	S	A	B	24	Rc		
sradx ¹	31	S	A	B	794	Rc		
srawx	31	S	A	B	792	Rc		
srawix	31	S	A	SH	824	Rc		
srdx ¹	31	S	A	B	539	Rc		
srwx	31	S	A	B	536	Rc		
stbux	31	S	A	B	247	0		
stbx	31	S	A	B	215	0		

stdcx. ¹	31	S	A	B	214	1
stdux ¹	31	S	A	B	181	0
stdx ¹	31	S	A	B	149	0
stfdx	31	S	A	B	759	0
stfdx	31	S	A	B	727	0
stfiwx ²	31	S	A	B	983	0
stfsux	31	S	A	B	695	0
stfsx	31	S	A	B	663	0
sthbrx	31	S	A	B	918	0
sthux	31	S	A	B	439	0
sthx	31	S	A	B	407	0
stswi ⁴	31	S	A	NB	725	0
stswx ⁴	31	S	A	B	661	0
stwbrx	31	S	A	B	662	0
stwcx.	31	S	A	B	150	1
stwux	31	S	A	B	183	0
stwx	31	S	A	B	151	0
sync	31	00000	00000	00000	598	0
td ¹	31	TO	A	B	68	0
tlbia ^{2,3}	31	00000	00000	00000	370	0
tlbie ^{2,3}	31	00000	00000	B	306	0
tlbsync ^{2,3}	31	00000	00000	00000	566	0
tw	31	TO	A	B	4	0
xorx	31	S	A	B	316	Rc

Notes:

¹ 64-bit instruction

² Optional instruction

³ Supervisor-level instruction

⁴ Load/store string/multiple instruction

⁵ Optional 64-bit bridge instruction

Table A-37. XL-Form

OPCD	BO	BI	0 0 0 0 0	XO	LK		
OPCD	crbD	crbA	crbB	XO	0		
OPCD	crfD	0 0	crfS	0 0	0 0 0 0 0	XO	0
OPCD	0 0 0 0 0	0 0 0 0 0	0 0 0 0 0	XO	0		

Specific Instructions

Name	0	5	6	7	8	9	10	11	12	13	14	15	16	17	18	19	20	21	22	23	24	25	26	27	28	29	30	31
bcctrx	19	BO	BI	0 0 0 0 0	528	LK																						
bclrx	19	BO	BI	0 0 0 0 0	16	LK																						
crand	19	crbD	crbA	crbB	257	0																						
crandc	19	crbD	crbA	crbB	129	0																						
creqv	19	crbD	crbA	crbB	289	0																						
crnand	19	crbD	crbA	crbB	225	0																						
crnor	19	crbD	crbA	crbB	33	0																						
cror	19	crbD	crbA	crbB	449	0																						
crorc	19	crbD	crbA	crbB	417	0																						
crxor	19	crbD	crbA	crbB	193	0																						
isync	19	0 0 0 0 0	0 0 0 0 0	0 0 0 0 0	150	0																						
mcrf	19	crfD	0 0	crfS	0 0	0 0 0 0 0	0	0																				
rfi ^{1,2}	19	0 0 0 0 0	0 0 0 0 0	0 0 0 0 0	50	0																						
rfid ^{1,3}	19	0 0 0 0 0	0 0 0 0 0	0 0 0 0 0	18	0																						

Notes:

- ¹ Supervisor-level instruction
- ² Optional 64-bit bridge instruction
- ³ 64-bit instruction

Table A-38. XFX-Form

OPCD	D	spr	XO	0		
OPCD	D	0	CRM	0	XO	0
OPCD	S	spr	XO	0		
OPCD	D	tbr	XO	0		

Specific Instructions

Name	0	5	6	7	8	9	10	11	12	13	14	15	16	17	18	19	20	21	22	23	24	25	26	27	28	29	30	31
mfspr ¹	31	D	spr	339	0																							

mtfb	31	D	tbr				371	0		
mtrcf	31	S	0	CRM				0	144	0
mtspr ¹	31	D	spr				467	0		

Note:

¹ Supervisor- and user-level instruction

Table A-39. XFL-Form

OPCD	0	FM				0	B	XO				Rc
------	---	----	--	--	--	---	---	----	--	--	--	----

Specific Instructions

Name	0	5	6	7	8	9	10	11	12	13	14	15	16	17	18	19	20	21	22	23	24	25	26	27	28	29	30	31
mtfsfx	63	0	FM				0	B	711				Rc															

Table A-40. XS-Form

OPCD	S	A	sh	XO				sh	Rc
------	---	---	----	----	--	--	--	----	----

Specific Instructions

Name	0	5	6	7	8	9	10	11	12	13	14	15	16	17	18	19	20	21	22	23	24	25	26	27	28	29	30	31
sradix ¹	31	S	A	sh	413				sh	Rc																		

Note:

¹ 64-bit instruction

Table A-41. XO-Form

OPCD	D	A	B	OE	XO				Rc
OPCD	D	A	B	0	XO				Rc
OPCD	D	A	0 0 0 0 0	OE	XO				Rc

Specific Instructions

Name	0	5	6	7	8	9	10	11	12	13	14	15	16	17	18	19	20	21	22	23	24	25	26	27	28	29	30	31
addx	31	D	A	B	OE	266				Rc																		
addcx	31	D	A	B	OE	10				Rc																		
addex	31	D	A	B	OE	138				Rc																		
addmex	31	D	A	0 0 0 0 0	OE	234				Rc																		
addzex	31	D	A	0 0 0 0 0	OE	202				Rc																		
divdx ¹	31	D	A	B	OE	489				Rc																		
divdux ¹	31	D	A	B	OE	457				Rc																		
divwx	31	D	A	B	OE	491				Rc																		

divw_x	31	D	A	B	OE	459	Rc
mulhd_x¹	31	D	A	B	0	73	Rc
mulhdu_x¹	31	D	A	B	0	9	Rc
mulhw_x	31	D	A	B	0	75	Rc
mulhwu_x	31	D	A	B	0	11	Rc
mulld_x¹	31	D	A	B	OE	233	Rc
mullw_x	31	D	A	B	OE	235	Rc
neg_x	31	D	A	00000	OE	104	Rc
subf_x	31	D	A	B	OE	40	Rc
subfc_x	31	D	A	B	OE	8	Rc
subfex	31	D	A	B	OE	136	Rc
subfmex	31	D	A	00000	OE	232	Rc
subfzex	31	D	A	00000	OE	200	Rc

Note:
¹ 64-bit instruction

Table A-42. A-Form

OPCD	D	A	B	00000	XO	Rc
OPCD	D	A	B	C	XO	Rc
OPCD	D	A	00000	C	XO	Rc
OPCD	D	00000	B	00000	XO	Rc

Specific Instructions

Name	0	5	6	7	8	9	10	11	12	13	14	15	16	17	18	19	20	21	22	23	24	25	26	27	28	29	30	31
fadd_x	63	D	A	B	00000	21	Rc																					
fadds_x	59	D	A	B	00000	21	Rc																					
fdiv_x	63	D	A	B	00000	18	Rc																					
fdivs_x	59	D	A	B	00000	18	Rc																					
fmadd_x	63	D	A	B	C	29	Rc																					
fmadds_x	59	D	A	B	C	29	Rc																					
fmsub_x	63	D	A	B	C	28	Rc																					
fmsubs_x	59	D	A	B	C	28	Rc																					
fmul_x	63	D	A	00000	C	25	Rc																					
fmuls_x	59	D	A	00000	C	25	Rc																					
fnmadd_x	63	D	A	B	C	31	Rc																					
fnmadds_x	59	D	A	B	C	31	Rc																					

fnmsubx	63	D	A	B	C	30	Rc
fnmsubsx	59	D	A	B	C	30	Rc
fresx ¹	59	D	0 0 0 0 0	B	0 0 0 0 0	24	Rc
frsqrtox ¹	63	D	0 0 0 0 0	B	0 0 0 0 0	26	Rc
fselx ¹	63	D	A	B	C	23	Rc
fsqrtx ¹	63	D	0 0 0 0 0	B	0 0 0 0 0	22	Rc
fsqrtsx ¹	59	D	0 0 0 0 0	B	0 0 0 0 0	22	Rc
fsubx	63	D	A	B	0 0 0 0 0	20	Rc
fsubsx	59	D	A	B	0 0 0 0 0	20	Rc

Note:

¹ Optional instruction

Table A-43. M-Form

OPCD	S	A	SH	MB	ME	Rc
OPCD	S	A	B	MB	ME	Rc

Specific Instructions

Name 0 5 6 7 8 9 10 11 12 13 14 15 16 17 18 19 20 21 22 23 24 25 26 27 28 29 30 31

rlwimx	20	S	A	SH	MB	ME	Rc
rlwinmx	21	S	A	SH	MB	ME	Rc
rlwnmx	23	S	A	B	MB	ME	Rc

Table A-44. MD-Form

OPCD	S	A	sh	mb	XO	sh	Rc
OPCD	S	A	sh	me	XO	sh	Rc

Specific Instructions

Name 0 5 6 7 8 9 10 11 12 13 14 15 16 17 18 19 20 21 22 23 24 25 26 27 28 29 30 31

rldicx ¹	30	S	A	sh	mb	2	sh	Rc
rldiclx ¹	30	S	A	sh	mb	0	sh	Rc
rldicrx ¹	30	S	A	sh	me	1	sh	Rc
rldimix ¹	30	S	A	sh	mb	3	sh	Rc

Note:

¹ 64-bit instruction

Table A-45. MDS-Form

OPCD	S	A	B	mb	XO	Rc
OPCD	S	A	B	me	XO	Rc

Specific Instructions

Name	0	5	6	7	8	9	10	11	12	13	14	15	16	17	18	19	20	21	22	23	24	25	26	27	28	29	30	31	
rdclx ¹	30	S	A	B	mb	8	Rc																						
rdcrx ¹	30	S	A	B	me	9	Rc																						

Note:
¹ 64-bit instruction

A.5 Instruction Set Legend

Table A-46 provides general information on the PowerPC instruction set (such as the architectural level, privilege level, and form).

Table A-46. PowerPC Instruction Set Legend

	UISA	VEA	OEA	Supervisor Level	64-Bit Only	64-Bit Bridge	Optional	Form
addx	√							XO
addcx	√							XO
addex	√							XO
addi	√							D
addic	√							D
addic.	√							D
addis	√							D
addmex	√							XO
addzex	√							XO
andx	√							X
andcx	√							X
andi.	√							D
andis.	√							D
bx	√							I
bcx	√							B
bcctrx	√							XL
bclrx	√							XL
cmp	√							X
cmpi	√							D
cmpl	√							X
cmpli	√							D
cntlzdx	√				√			X
cntlzwx	√							X
crand	√							XL
crandc	√							XL
creqv	√							XL
crnand	√							XL
crnor	√							XL

Table A-46. PowerPC Instruction Set Legend (Continued)

	UISA	VEA	OEA	Supervisor Level	64-Bit Only	64-Bit Bridge	Optional	Form
cror	√							XL
crorc	√							XL
crxor	√							XL
dcba		√					√	X
dcbf		√						X
dcbi			√	√				X
dcbst		√						X
dcbt		√						X
dcbtst		√						X
dcbz		√						X
divdx	√				√			XO
divdux	√				√			XO
divwx	√							XO
divwux	√							XO
eciwx		√					√	X
ecowx		√					√	X
eieio		√						X
eqvx	√							X
extsbx	√							X
extshx	√							X
extswx	√				√			X
fabsx	√							X
faddx	√							A
faddsx	√							A
fcfidx	√				√			X
fcmpo	√							X
fcmpu	√							X
fctidx	√				√			X
fctidzx	√				√			X
fctiwx	√							X
fctiwzx	√						√	X
fdivx	√							A

Table A-46. PowerPC Instruction Set Legend (Continued)

	UISA	VEA	OEA	Supervisor Level	64-Bit Only	64-Bit Bridge	Optional	Form
fdivsx	√							A
fmaddx	√							A
fmaddsx	√							A
fmr_x	√							X
fmsub_x	√							A
fmsub_{sx}	√							A
fmul_x	√							A
fmul_{sx}	√							A
fnabs_x	√							X
fneg_x	√							X
fnmadd_x	√							A
fnmadd_{sx}	√							A
fnmsub_x	√							A
fnmsub_{sx}	√							A
fres_x	√						√	A
frsp_x	√							X
frsqr_{tex}	√						√	A
fsel_x	√						√	A
fsqr_{t_x}	√						√	A
fsqr_{t_{sx}}	√						√	A
fsub_x	√							A
fsub_{sx}	√							A
icbi		√						X
isync		√						XL
lbz	√							D
lbzu	√							D
lbzux	√							X
lbzx	√							X
ld	√				√			DS
ldar_x	√				√			X
ldu	√				√			DS
ldux	√				√			X

Table A-46. PowerPC Instruction Set Legend (Continued)

	UISA	VEA	OEA	Supervisor Level	64-Bit Only	64-Bit Bridge	Optional	Form
ldx	√				√			X
lfd	√							D
lfdx	√							X
lfdx	√							X
lfs	√							D
lfsu	√							D
lfsux	√							X
lfsx	√							X
lha	√							D
lhau	√							D
lhaux	√							X
lhax	√							X
lhbrx	√							X
lhz	√							D
lhzu	√							D
lhzux	√							X
lhzx	√							X
lmw ²	√							D
lswi ²	√							X
lswx ²	√							X
lwa	√				√			DS
lwarx	√							X
lwaux	√				√			X
lwax	√				√			X
lwbrx	√							X
lwz	√							D
lwzu	√							D
lwzux	√							X
lwzx	√							X
mcrf	√							XL
mcrfs	√							X

Table A-46. PowerPC Instruction Set Legend (Continued)

	UISA	VEA	OEA	Supervisor Level	64-Bit Only	64-Bit Bridge	Optional	Form
mcrxr	√							X
mfcr	√							X
mffs	√							X
mfmsr			√	√				X
mfspr ¹	√		√	√				XFx
mfsr			√	√		√	√	X
mfsrin			√	√		√	√	X
mftb		√						XFx
mtrcf	√							XFx
mtfsb0x	√							X
mtfsb1x	√							X
mtfsfx	√							XFL
mtfsfix	√							X
mtmsr			√	√		√	√	X
mtmsrd			√	√	√			X
mtspr ¹	√		√	√				XFx
mtsr			√	√		√	√	X
mtsrđ			√	√	√	√	√	X
mtsrđin			√	√	√	√	√	X
mtsrin			√	√		√	√	X
mulđx	√				√			XO
mulđux	√				√			XO
mulhw _x	√							XO
mulhw _{ux}	√							XO
mullđx	√				√			XO
mulli	√							D
mullw _x	√							XO
nand _x	√							X
neg _x	√							XO
nor _x	√							X
or _x	√							X
orc _x	√							X

Table A-46. PowerPC Instruction Set Legend (Continued)

	UISA	VEA	OEA	Supervisor Level	64-Bit Only	64-Bit Bridge	Optional	Form
ori	√							D
oris	√							D
rfi			√	√	√	√	√	XL
rfid			√	√	√			XL
rdclx	√				√			MDS
rdcrx	√				√			MDS
rdicx	√				√			MD
rdicl _x	√				√			MD
rdicr _x	√				√			MD
rdimix	√				√			MD
rlwimix	√							M
rlwinm _x	√							M
rlwnm _x	√							M
sc	√		√					SC
slbia			√	√	√		√	X
slbie			√	√	√		√	X
sld _x	√				√			X
slw _x	√							X
srad _x	√				√			X
sradix	√				√			XS
sraw _x	√							X
srawix	√							X
srd _x	√				√			X
srw _x	√							X
stb	√							D
stbu	√							D
stbux	√							X
stbx	√							X
std	√				√			DS
stdc _x	√				√			X
stdu	√				√			DS
stdux	√				√			X

Table A-46. PowerPC Instruction Set Legend (Continued)

	UISA	VEA	OEA	Supervisor Level	64-Bit Only	64-Bit Bridge	Optional	Form
stdx	√				√			X
stfd	√							D
stfdu	√							D
stfdx	√							X
stfdx	√							X
stfiwx	√						√	X
stfs	√							D
stfsu	√							D
stfsux	√							X
stfsx	√							X
sth	√							D
sthbrx	√							X
sthu	√							D
sthux	√							X
sthx	√							X
stmw ²	√							D
stswi ²	√							X
stswx ²	√							X
stw	√							D
stwbrx	√							X
stwcx.	√							X
stwu	√							D
stwux	√							X
stwx	√							X
subfx	√							XO
subfcx	√							XO
subfex	√							XO
subfic	√							D
subfmex	√							XO
subfzex	√							XO
sync	√							X
td	√				√			X

Table A-46. PowerPC Instruction Set Legend (Continued)

	UISA	VEA	OEA	Supervisor Level	64-Bit Only	64-Bit Bridge	Optional	Form
tdi	√				√			D
tlbiax			√	√			√	X
tlbiex			√	√			√	X
tlbsync			√	√				X
tw	√							X
twi	√							D
xorx	√							X
xori	√							D
xoris	√							D

Notes:

¹ Supervisor- and user-level instruction

² Load/store string or multiple instruction

Appendix B

POWER Architecture Cross Reference

This appendix identifies the incompatibilities that must be managed in migration from the POWER architecture to PowerPC architecture. Some of the incompatibilities can, at least in principle, be detected by the processor, which traps and lets software simulate the POWER operation. Others cannot be detected by the processor.

In general, the incompatibilities identified here are those that affect a POWER application program. Incompatibilities for instructions that can be used only by POWER system programs are not discussed. Note that this appendix describes incompatibilities with respect to the PowerPC architecture in general.

B.1 New Instructions, Formerly Supervisor-Level Instructions

Instructions new to PowerPC typically use opcode values (including extended opcode) that are illegal in the POWER architecture. A few instructions that are supervisor-level in the POWER architecture (for example, **dclz**, called **dcbz** in the PowerPC architecture) have been made user-level in the PowerPC architecture. Any POWER program that executes one of these now-valid, or now-user-level, instructions expecting to cause the system illegal instruction error handler (program exception) or the system supervisor-level instruction error handler to be invoked, will not execute correctly on PowerPC processors. (Note that, in the architecture specification, user- and supervisor-level are referred to as problem and privileged state, respectively, and exceptions are referred to as interrupts.)

B.2 New Supervisor-Level Instructions

The following instructions are user-level in the POWER architecture but are supervisor-level in PowerPC processors.

- **mfmsr**
- **mfsr**

B.3 Reserved Bits in Instructions

These are shown as zeros and the bit field is shaded in the instruction opcode definitions. In the POWER architecture such bits are ignored by the processor. In the PowerPC architecture they must be zero or the instruction form is invalid. In several cases, the PowerPC architecture assumes that such bits in POWER instructions are indeed zero. The cases include the following:

- **cmpi**, **cmp**, **cmpli**, and **cmpl** assume that bit 10 in the POWER instructions is 0.
- **mtspr** and **mfspr** assume that bits 16–20 in the POWER instructions are 0.

B.4 Reserved Bits in Registers

The POWER architecture defines these bits to be zero when read, and either zero or one when written to. In the PowerPC architecture it is implementation-dependent for each register, whether these bits are zero when read, and ignored when written to, or are copied from source to destination when read or written to.

B.5 Alignment Check

The AL bit in the POWER machine state register, MSR[24], is not supported in the PowerPC architecture. The bit is reserved in the PowerPC architecture. The low-order bits of the EA are always used. Notice that value zero—the normal value for a reserved SPR bit—means ignore the low-order EA bits in the POWER architecture, and value one means use the low-order EA bits. However, MSR[24] is not assigned new meaning in the PowerPC architecture.

B.6 Condition Register

The following instructions specify a field in the condition register (CR) explicitly (via the **crfD** field) and also have the record bit (Rc) option. In the PowerPC architecture, if Rc = 1 for these instructions the instruction form is invalid. In the POWER architecture, if Rc = 1 the instructions execute normally except as shown in Table B-1.

Table B-1. Condition Register Settings

Instruction	Setting
cmp	CR0 is undefined if Rc = 1 and crfD ≠ 0
cmpl	CR0 is undefined if Rc = 1 and crfD ≠ 0
mcrxr	CR0 is undefined if Rc = 1 and crfD ≠ 0
fcmpu	CR1 is undefined if Rc = 1
fcmpo	CR1 is undefined if Rc = 1
mcrfs	CR1 is undefined if Rc = 1 and crfD ≠ 1

B.7 Inappropriate Use of LK and Rc bits

For the instructions listed below, if LK = 1 or Rc = 1, POWER processors execute the instruction normally with the exception of setting the link register (if LK = 1) or the CR0 or CR1 fields (if Rc = 1) to an undefined value. In the PowerPC architecture, such instruction forms are invalid.

The PowerPC instruction form is invalid if LK = 1:

- **sc** (**svcx** in the POWER architecture)
- Condition register logical instructions (that is, **crand**, **crandc**, **creqv**, **crnand**, **crnor**, **cror**, **crorc**, and **crxor**)
- **mcrf**
- **isync** (**ics** in the POWER architecture)

The PowerPC instruction form is invalid if Rc = 1:

- Integer X-form load and store instructions:
 - X-form load instructions—**lbzux**, **lbzx**, **ldarx**, **ldux**, **ldx**, **lhaux**, **lhax**, **lhbrx**, **lhzux**, **lhzx**, **lswi**, **lswx**, **lwarx**, **lwaux**, **lwax**, **lwbrx**, **lwzux**, **lwzx**
 - X-form store instructions—**stbux**, **stbx**, **stdcx.**, **stdux**, **stdx**, **sthbrx**, **sthux**, **sthx**, **stswi**, **stswx**, **stwbrx**, **stwcx.**, **stwux**, **stwx**
- Integer X-form compare instructions (that is, **cmp**, **cmpl**)
- X-form trap instruction (that is, **td**)
- **mtspr**, **mfspr**, **mtrf**, **merxr**, **mfer**
- Floating-point X-form load and store instructions and floating-point compare instructions
 - Floating-point X-form load instructions—**lfdux**, **lfdx**, **lfsux**, **lfsx**
 - Floating-point X-form store instructions—**stfdx**, **stfdx**, **stfiwx**, **stfsux**, **stfsx**
 - Floating-point X-form compare instruction—**fcmpo**, **fcmpu**
- **mcrfs**
- **dcbz** (**dclz** in the POWER architecture)

B.8 BO Field

The POWER architecture shows certain bits in the BO field—used by branch conditional instructions—as *x* without indicating how these bits are to be interpreted. These bits are ignored by POWER processors.

The PowerPC architecture shows these bits as either *z* or *y*. The *z* bits are ignored, as in POWER. However, the *y* bit need not be ignored, but rather can be used to give a hint about whether the branch is likely to be taken. If a POWER program has the incorrect value for this bit, the program will run correctly but performance may suffer.

B.9 Branch Conditional to Count Register

For the case in which the count register is decremented and tested (that is, the case in which $BO[2] = 0$), the POWER architecture specifies only that the branch target address is undefined, implying that the count register, and the link register (if $LK = 1$), are updated in the normal way. The PowerPC architecture considers this instruction form invalid.

B.10 System Call/Supervisor Call

The System Call (**sc**) instruction in the PowerPC architecture is called Supervisor Call (**svcx**) in the POWER architecture. Differences in implementations are as follows:

- The POWER architecture provides a version of the **svcx** instruction (bit 30 = 0) that allows instruction fetching to continue at any one of 128 locations. It is used for “fast Supervisor Calls.” The PowerPC architecture provides no such version. If bit 30 of the instruction is zero the instruction form is invalid.
- The POWER architecture provides a version of the **svcx** instruction (bits 30–31 = 0b11) that resumes instruction fetching at one location and sets the link register (LR) to the address of the next instruction. The PowerPC architecture provides no such version; if $Rc = 1$, the instruction form is invalid.
- For the POWER architecture, information from the MSR is saved in the count register (CTR). For the PowerPC architecture, this information is saved in the machine status save/restore register 1 (SRR1).
- The POWER architecture permits bits 16–29 of the instruction to be nonzero, while in the PowerPC architecture, such an instruction form is invalid.
- The POWER architecture saves the low-order 16 bits of the **svcx** instruction in the CTR; the PowerPC architecture does not save them.
- The settings of the MSR bits by the system call exception differ between the POWER architecture and the PowerPC architecture.

B.11 XER Register

Bits 16–23 of the XER are reserved in the PowerPC architecture, whereas in the POWER architecture they are defined to contain the comparison byte for the **lscbx** instruction, which is not included in the PowerPC architecture.

B.12 Update Forms of Memory Access

The PowerPC architecture requires that **rA** not be equal to either **rD** (integer load only) or zero. If the restriction is violated, the instruction form is invalid. See Section 4.1.3, “Classes of Instructions,” for information about invalid instructions. The POWER architecture permits these cases and simply avoids saving the EA.

B.13 Multiple Register Loads

When executing instructions that load multiple registers, the PowerPC architecture requires that **rA**, and **rB** if present in the instruction format, not be in the range of registers to be loaded, while the POWER architecture permits this and does not alter **rA** or **rB** in this case. (The PowerPC architecture restriction applies even if **rA** = 0, although there is no obvious benefit to the restriction in this case since **rA** is not used to compute the effective address if **rA** = 0.) If the PowerPC architecture restriction is violated, either the system illegal instruction error handler is invoked or the results are boundedly undefined.

The instructions affected are listed as follows:

- **lmw** (**lm** in the POWER architecture)
- **lswi** (**lsi** in the POWER architecture)
- **lswx** (**lsx** in the POWER architecture)

For example, an **lmw** instruction that loads all 32 registers is valid in the POWER architecture but is an invalid form in the PowerPC architecture.

B.14 Alignment for Load/Store Multiple

When executing load/store multiple instructions, the PowerPC architecture requires the EA to be word-aligned and yields an alignment exception or boundedly-undefined results if it is not. The POWER architecture specifies that an alignment exception occurs (if AL = 1).

B.15 Load and Store String Instructions

In the PowerPC architecture, an **lswx** instruction with zero length leaves the content of **rD** undefined (if **rD** ≠ **rA** and **rD** ≠ **rB**) or is an invalid instruction form (if **rD** = **rA** or **rD** = **rB**), while in the POWER architecture the corresponding instruction (**lsx**) is a no-op in these cases.

Note also that, in the PowerPC architecture, an **lswx** instruction with zero length may alter the referenced bit, and an **stswx** instruction with zero length may alter the referenced and changed bits, while in the POWER architecture the corresponding instructions (**lsx** and **stsx**) do not alter the referenced and changed bits.

B.16 Synchronization

The **sync** instruction (called **dcs** in the POWER architecture) and the **isync** instruction (called the **ics** in the POWER architecture) cause a much more pervasive synchronization in the PowerPC architecture than in the POWER architecture. For more information, refer to Chapter 8, “Instruction Set.”

B.17 Move to/from SPR

Differences in how the Move to/from Special Purpose Register (**mtspr** and **mfspir**) instructions function are as follows:

- The SPR field is 10 bits long in the PowerPC architecture, but only 5 bits in POWER architecture.
- The **mfspir** instruction can be used to read the decremter (DEC) register in problem state (user mode) in the POWER architecture, but only in supervisor state in the PowerPC architecture.
- If the SPR value specified in the instruction is not one of the defined values, the POWER architecture behaves as follows:
 - If the instruction is executed in user-level privilege state and $SPR[0] = 1$, a supervisor-level instruction type program exception occurs. No architected registers are altered except those set by the exception.
 - If the instruction is executed in supervisor-level privilege state and $SPR[0] = 0$, no architected registers are altered.

In this same case, the PowerPC architecture behaves as follows:

- If the instruction is executed in user-level privilege state and $SPR[0] = 1$, either an illegal instruction type program exception or a supervisor-level instruction type program exception occurs. No architected registers are altered except those set by the exception.
- Otherwise, (the instruction is executed in supervisor-level privilege state or $SPR[0] = 0$), either an illegal instruction type program exception occurs (in which case no architected registers are altered except those set by the exception) or the results are boundedly undefined.

B.18 Effects of Exceptions on FPSCR Bits FR and FI

For the following cases, the POWER architecture does not specify how the FR and FI bits are set, while the PowerPC architecture preserves them for illegal operation exceptions caused by compare instructions and clears them otherwise.

- Invalid operation exception (enabled or disabled)
- Zero divide exception (enabled or disabled)
- Disabled overflow exception

B.19 Floating-Point Store Single Instructions

There are several respects in which the PowerPC architecture is incompatible with the POWER architecture when executing store floating-point single instructions.

The POWER architecture uses FPSCR[UE] to help determine whether denormalization should be done, while the PowerPC architecture does not. Note that in the PowerPC architecture, if FPSCR[UE] = 1 and a denormalized single-precision number is copied from one memory location to another by means of an **lfs** instruction followed by an **stfs** instruction, the two “copies” may not be the same. Refer to Section 3.3.6.2.2, “Underflow Exception Condition,” for more information about underflow exceptions.

For an operand having an exponent that is less than 874 (an unbiased exponent less than -149), the POWER architecture specifies storage of a zero (if FPSCR[UE] = 0), while the PowerPC architecture specifies the storage of an undefined value.

B.20 Move from FPSCR

The POWER architecture defines the high-order 32 bits of the result of **mffs** to be 0xFFFF_FFFF. In the PowerPC architecture they are undefined.

B.21 Clearing Bytes in the Data Cache

The **dclz** instruction of the POWER architecture and the **dcbz** instruction of the PowerPC architecture have the same opcode. However, the functions differ in the following respects.

- The **dclz** instruction clears a line; **dcbz** clears a block.
- The **dclz** instruction saves the EA in **rA** (if **rA** ≠ 0); **dcbz** does not.
- The **dclz** instruction is supervisor-level; **dcbz** is not.

B.22 Segment Register Instructions

The definitions of the four segment register instructions (**mtsr**, **mtsrin**, **mfsr**, and **mfsrin**) differ in two respects between the POWER architecture and the PowerPC architecture. Instructions similar to **mtsrin** and **mfsrin** are called **mtsri** and **mfsri** in the POWER architecture. The definitions follow:

- Privilege—**mfsr** and **mfsri** are problem state instructions in the POWER architecture, while **mfsr** and **mfsrin** are supervisor-level in the PowerPC architecture.
- Function—the indirect instructions (**mtsri** and **mfsri**) in the POWER architecture use an **rA** register in computing the segment register number, and the computed EA is stored into **rA** (if **rA** ≠ 0 and **rA** ≠ **rD**); in the PowerPC architecture **mtsrin** and **mfsrin** have no **rA** field and EA is not stored.

The **mtsr**, **mtsrin** (**mtsri**), and **mfsr** instructions have the same opcodes in the PowerPC architecture as in the POWER architecture. The **mfsri** instruction in the POWER architecture and the **mfsrin** instruction in PowerPC architecture have different opcodes.

B.23 TLB Entry Invalidation

The **tlbi** instruction in the POWER architecture and the **tlbie** instruction in the PowerPC architecture have the same opcode. However, the functions differ in the following respects.

- The **tlbi** instruction computes the EA as $(rA|0) + rB$, while **tlbie** lacks an **rA** field and computes the EA as **rB**.
- The **tlbi** instruction saves the EA in **rA** (if **rA** \neq 0); **tlbie** lacks an **rA** field and does not save the EA.

B.24 Floating-Point Exceptions

Both the PowerPC and the POWER architectures use bit 20 of the MSR to control the generation of exceptions for floating-point enabled exceptions. However, in the PowerPC architecture this bit is part of a 2-bit value which controls the occurrence, precision, and recoverability of the exception, whereas, in the POWER architecture this bit is used independently to control the occurrence of the exception (in the POWER architecture all floating-point exceptions are precise).

B.25 Timing Facilities

This section describes differences between the POWER architecture and the PowerPC architecture timer facilities.

B.25.1 Real-Time Clock

The POWER real-time clock (RTC) is not supported in the PowerPC architecture. Instead, the PowerPC architecture provides a time base register (TB). Both the RTC and the TB are 64-bit special-purpose registers, but they differ in the following respects:

- The RTC counts seconds and nanoseconds, while the TB counts ticks. The frequency of the TB is implementation-dependent.
- The RTC increments discontinuously—1 is added to RTCU when the value in RTCL passes 999_999_999. The TB increments continuously—1 is added to TBU when the value in TBL passes 0xFFFF_FFFF.
- The RTC is written and read by the **mtspr** and **mfspr** instructions, using SPR numbers that denote the RTCU and RTCD. The TB is written by the **mtspr** instruction (using new SPR numbers) and read by the new **mftb** instruction.
- The SPR numbers that denote POWER architectures's RTCL and RTCU are invalid in the PowerPC architecture.

- The RTC is guaranteed to increment at least once in the time required to execute ten Add Immediate (**addi**) instructions. No analogous guarantee is made for the TB.
- Not all bits of RTCL need be implemented, while all bits of the TB must be implemented.

B.25.2 Decrementer

The decrementer (DEC) register differs, in the PowerPC and POWER architectures, in the following respects:

- The PowerPC architecture DEC register decrements at the same rate that the TB increments, while the POWER decrementer decrements every nanosecond (which is the same rate that the RTC increments).
- Not all bits of the POWER DEC need be implemented, while all bits of the PowerPC DEC must be implemented.
- The exception caused by the DEC has its own exception vector location in the PowerPC architecture, but is considered an external exception in the POWER architecture.

B.26 Deleted Instructions

The following instructions, shown in Table B-2, are part of the POWER architecture but have been dropped from the PowerPC architecture.

Table B-2. Deleted POWER Instructions

Mnemonic	Instruction	Primary Opcode	Extended Opcode
abs	Absolute	31	360
clcs	Cache Line Compute Size	31	531
clf	Cache Line Flush	31	118
cli	Cache Line Invalidate	31	502
dclst	Data Cache Line Store	31	630
div	Divide	31	331
divs	Divide Short	31	363
doz	Difference or Zero	31	264
dozi	Difference or Zero Immediate	09	—
lscbx	Load String and Compare Byte Indexed	31	277
maskg	Mask Generate	31	29
maskir	Mask Insert from Register	31	541
mfsrin	Move from Segment Register Indirect	31	627
mul	Multiply	31	107

Table B-2. Deleted POWER Instructions (Continued)

Mnemonic	Instruction	Primary Opcode	Extended Opcode
nabs	Negative Absolute	31	488
rac	Real Address Compute	31	818
rlmi	Rotate Left then Mask Insert	22	—
rrib	Rotate Right and Insert Bit	31	537
sle	Shift Left Extended	31	153
sleq	Shift Left Extended with MQ	31	217
sliq	Shift Left Immediate with MQ	31	184
slliq	Shift Left Long Immediate with MQ	31	248
sllq	Shift Left Long with MQ	31	216
slq	Shift Left with MQ	31	152
sraiq	Shift Right Algebraic Immediate with MQ	31	952
sraq	Shift Right Algebraic with MQ	31	920
sre	Shift Right Extended	31	665
srea	Shift Right Extended Algebraic	31	921
sreq	Shift Right Extended with MQ	31	729
sriq	Shift Right Immediate with MQ	31	696
srlmq	Shift Right Long Immediate with MQ	31	760
srlq	Shift Right Long with MQ	31	728
srq	Shift Right with MQ	31	664

Note: Many of these instructions use the MQ register. The MQ is not defined in the PowerPC architecture.

B.27 POWER Instructions Supported by the PowerPC Architecture

Table B-3 lists the POWER instructions implemented in the PowerPC architecture.

Table B-3. POWER Instructions Implemented in PowerPC Architecture

POWER		PowerPC	
Mnemonic	Instruction	Mnemonic	Instruction
ax	Add	addcx	Add Carrying
aex	Add Extended	addex	Add Extended
ai	Add Immediate	addic	Add Immediate Carrying
ai.	Add Immediate and Record	addic.	Add Immediate Carrying and Record
amex	Add to Minus One Extended	addmex	Add to Minus One Extended
andil.	AND Immediate Lower	andi.	AND Immediate
andiu.	AND Immediate Upper	andis.	AND Immediate Shifted
azex	Add to Zero Extended	addzex	Add to Zero Extended
bccx	Branch Conditional to Count Register	bcctrx	Branch Conditional to Count Register
bcrx	Branch Conditional to Link Register	bclrx	Branch Conditional to Link Register
cal	Compute Address Lower	addi	Add Immediate
cau	Compute Address Upper	addis	Add Immediate Shifted
caxx	Compute Address	addx	Add
cntlzx	Count Leading Zeros	cntlzwx	Count Leading Zeros Word
dclz	Data Cache Line Set to Zero	dcbz	Data Cache Block Set to Zero
dcs	Data Cache Synchronize	sync	Synchronize
extsx	Extend Sign	extshx	Extend Sign Half Word
fax	Floating Add	faddx	Floating Add
fdx	Floating Divide	fdivx	Floating Divide
fmx	Floating Multiply	fmulx	Floating Multiply
fmax	Floating Multiply-Add	fmaddx	Floating Multiply-Add
fmsx	Floating Multiply-Subtract	fmsubx	Floating Multiply-Subtract
fnmax	Floating Negative Multiply-Add	fnmaddx	Floating Negative Multiply-Add
fnmsx	Floating Negative Multiply-Subtract	fnmsubx	Floating Negative Multiply-Subtract
fsx	Floating Subtract	fsubx	Floating Subtract
ics	Instruction Cache Synchronize	isync	Instruction Synchronize
l	Load	lwz	Load Word and Zero
lbrx	Load Byte-Reverse Indexed	lwbrx	Load Word Byte-Reverse Indexed

Table B-3. POWER Instructions Implemented in PowerPC Architecture (Continued)

POWER		PowerPC	
Mnemonic	Instruction	Mnemonic	Instruction
lm	Load Multiple	lmw	Load Multiple Word
lsi	Load String Immediate	lswi	Load String Word Immediate
lsx	Load String Indexed	lswx	Load String Word Indexed
lu	Load with Update	lwzu	Load Word and Zero with Update
lux	Load with Update Indexed	lwzux	Load Word and Zero with Update Indexed
lx	Load Indexed	lwzx	Load Word and Zero Indexed
mtsri	Move to Segment Register Indirect	mtsriin	Move to Segment Register Indirect *
muli	Multiply Immediate	mulli	Multiply Low Immediate
mulsx	Multiply Short	mullwx	Multiply Low
oril	OR Immediate Lower	ori	OR Immediate
oriu	OR Immediate Upper	oris	OR Immediate Shifted
rlmix	Rotate Left Immediate then Mask Insert	rlwimix	Rotate Left Word Immediate then Mask Insert
rlnmx	Rotate Left Immediate then AND With Mask	rlwinmx	Rotate Left Word Immediate then AND with Mask
rlnmx	Rotate Left then AND with Mask	rlwnmx	Rotate Left Word then AND with Mask
sfx	Subtract from	subfcx	Subtract from Carrying
sfex	Subtract from Extended	subfex	Subtract from Extended
sfi	Subtract from Immediate	subfic	Subtract from Immediate Carrying
sfmex	Subtract from Minus One Extended	subfmex	Subtract from Minus One Extended
sfzex	Subtract from Zero Extended	subfzex	Subtract from Zero Extended
slx	Shift Left	slwx	Shift Left Word
srx	Shift Right	srwx	Shift Right Word
srax	Shift Right Algebraic	srawx	Shift Right Algebraic Word
sraix	Shift Right Algebraic Immediate	srawix	Shift Right Algebraic Word Immediate
st	Store	stw	Store Word
stbrx	Store Byte-Reverse Indexed	stwbrx	Store Word Byte-Reverse Indexed
stm	Store Multiple	stmw	Store Multiple Word
stsi	Store String Immediate	stswi	Store String Word Immediate
stsx	Store String Indexed	stswx	Store String Word Indexed
stu	Store with Update	stwu	Store Word with Update

Table B-3. POWER Instructions Implemented in PowerPC Architecture (Continued)

POWER		PowerPC	
Mnemonic	Instruction	Mnemonic	Instruction
stux	Store with Update Indexed	stwux	Store Word with Update Indexed
stx	Store Indexed	stwx	Store Word Indexed
svca	Supervisor Call	sc	System Call
t	Trap	tw	Trap Word
ti	Trap Immediate	twi	Trap Word Immediate *
tlbi	TLB Invalidate Entry	tlbie	Translation Lookaside Buffer Invalidate Entry
xoril	XOR Immediate Lower	xori	XOR Immediate
xoriu	XOR Immediate Upper	xoris	XOR Immediate Shifted

* Supervisor-level instruction

Appendix C

Multiple-Precision Shifts

This appendix gives examples of how multiple precision shifts can be programmed. A multiple-precision shift is initially defined to be a shift of an n -double word quantity (64-bit mode) or an n -word quantity (32-bit mode), where $n > 1$. The quantity to be shifted is contained in n registers (in the low-order 32 bits in 32-bit mode). The shift amount is specified either by an immediate value in the instruction or by bits 57–63 (64-bit mode) or 58–63 (32-bit mode) of a register.

The examples shown below distinguish between the cases $n = 2$ and $n > 2$. If $n = 2$, the shift amount may be in the range 0–127 (64-bit mode), or 0–63 (32-bit mode), which are the maximum ranges supported by the shift instructions used. However if $n > 2$, the shift amount must be in the range 0–63 (64-bit mode), or 0–31 (32-bit mode), for the examples to yield the desired result. The specific instance shown for $n > 2$ is $n = 3$: extending those instruction sequences to larger n is straightforward, as is reducing them to the case $n = 2$ when the more stringent restriction on shift amount is met. For shifts with immediate shift amounts, only the case $n = 3$ is shown because the more stringent restriction on shift amount is always met.

In the examples it is assumed that GPRs 2 and 3 (and 4) contain the quantity to be shifted, and that the result is to be placed into the same registers, except for the immediate left shifts in 64-bit mode for which the result is placed into GPRs 3, 4, and 5. In all cases, for both input and result, the lowest-numbered register contains the highest-order part of the data and highest-numbered register contains the lowest-order part. In 32-bit mode, the high-order 32 bits of these registers are assumed not to be part of the quantity to be shifted nor of the result. For non-immediate shifts, the shift amount is assumed to be in bits 57–63 (64-bit mode), or 58–63 (32-bit mode), of GPR6. For immediate shifts, the shift amount is assumed to be greater than zero. GPRs 0–31 are used as scratch registers. For $n > 2$, the number of instructions required is $2n - 1$ (immediate shifts) or $3n - 1$ (non-immediate shifts).

The following sections provide examples of multiple-precision shifts in both 64- and 32-bit modes.

C.1 Multiple-Precision Shifts in 64-Bit Mode

Shift Left Immediate, $n = 3$ (Shift Amount < 64)

```
rldicr r5,r4,sh,63 - sh
rldimi r4,r3,0,sh
rldicl r4,r4,sh,0
rldimi r3,r2,0,sh
rldicl r3,r3,sh,0
```

Shift Left, $n = 2$ (Shift Amount < 128)

```
subfic r31,r6,64
sld r2,r2,r6
srd r0,r3,r31
or r2,r2,r0
addi r31,r6,-64
sld r0,r3,r31
or r2,r2,r0
sld r3,r3,r6
```

Shift Left, $n = 3$ (Shift Amount < 64)

```
subfic r31,r6,64
sld r2,r2,r6
srd r0,r3,r31
or r2,r2,r0
sld r3,r3,r6
srd r0,r4,r31
or r3,r3,r0
sld r4,r4,r6
```

Shift Right Immediate, $n = 3$ (Shift Amount < 64)

```
rldimi r4,r3,0,64 - sh
rldicl r4,r4,64 - sh,0
rldimi r3,r2,0,64 - sh
rldicl r3,r3,64 - sh,0
rldicl r2,r2,64 - sh,sh
```

Shift Right, $n = 2$ (Shift Amount < 128)

```
subfic r31,r6,64
srd r3,r3,r6
sld r0,r2,r31
or r3,r3,r0
addi r31,r6,-64
srd r0,r2,r31
or r3,r3,r0
srd r2,r2,r6
```

Shift Right, $n = 3$ (Shift Amount < 64)

```
subfic r31,r6,64
srd r4,r4,r6
sld r0,r3,r31
or r4,r4,r0
srd r3,r3,r6
sld r0,r2,r31
or r3,r3,r0
srd r2,r2,r6
```

Shift Right Algebraic Immediate, $n = 3$ (Shift Amount < 64)

```
rldimi r4,r4,0,64 - sh
rldicl r4,r4,64 - sh,0
rldimi r3,r2,0,64 - sh
rldicl r3,r3,64 - sh,0
sradi r2,r2,sh
```

Shift Right Algebraic, $n = 2$ (Shift Amount < 128)

```
subfic r31,r6,64
srd r3,r3,r6
sld r0,r2,r31
or r3,r3,r0
addic. r31,r6,-64
srad r0,r2,r31
ble $+8
ori r3,r0,0
srad r2,r2,r6
```

Shift Right Algebraic, $n = 3$ (Shift Amount < 64)

```
subfic r31,r6,64
srd r4,r4,r6
sld r0,r3,r31
or r4,r4,r0
srd r3,r3,r6
sld r0,r2,r31
or r3,r3,r0
srad r2,r2,r6
```

C.2 Multiple-Precision Shifts in 32-Bit Mode

Shift Left Immediate, $n = 3$ (Shift Amount < 32)

```
rlwinm r2,r2,sh,0,31 - sh
rlwimi r2,r3,sh,32 - sh,31
rlwinm r3,r3,sh,0,31 - sh
rlwimi r3,r4,sh,32 - sh,31
rlwinm r4,r4,sh,0,31 - sh
```

Shift Left, $n = 2$ (Shift Amount < 64)

```
subfic r31,r6,32
slw r2,r2,r6
srw r0,r3,r31
or r2,r2,r0
addi r31,r6,-32
slw r0,r3,r31
or r2,r2,r0
slw r3,r3,r6
```

Shift Left, $n = 3$ (Shift Amount < 32)

```
subfic r31,r6,32
slw r2,r2,r6
srw r0,r3,r31
or r2,r2,r0
slw r3,r3,r6
srw r0,r4,r31
or r3,r3,r0
slw r4,r4,r6
```

Shift Right Immediate, $n = 3$ (Shift Amount < 32)

```
rlwinm r4,r4,32 - sh,sh,31
rlwimi r4,r3,32 - sh,0,sh - 1
rlwinm r3,r3,32 - sh,sh,31
rlwimi r3,r2,32 - sh,0,sh - 1
rlwinm r2,r2,32 - sh,sh,31
```

Shift Right, $n = 2$ (Shift Amount < 64)

```
subfic r31,r6,32
srw r3,r3,r6
slw r0,r2,r31
or r3,r3,r0
addi r31,r6, -32
srw r0,r2,r31
or r3,r3,r0
srw r2,r2,r6
```

Shift Right, $n = 3$ (Shift Amount < 32)

```
subfic r31,r6,-32
srw r4,r4,r6
slw r0,r3,r31
or r4,r4,r0
srw r3,r3,r6
slw r0,r2,r31
or r3,r3,r0
srw r2,r2,r6
```

Shift Right Algebraic Immediate, $n = 3$ (Shift Amount < 32)

```
rlwinm r4,r4,32 - sh,sh,31
rlwimi r4,r3,32 - sh,0,sh - 1
rlwinm r3,r3,32 - sh,sh,31
rlwimi r3,r2,32 - sh,0,sh - 1
srawi r2,r2,sh
```

Shift Right Algebraic, $n = 2$ (Shift Amount < 64)

```
subfic r31,r6,32
srw r3,r3,r6
slw r0,r2,r31
or r3,r3,r0
addic. r31,r6,-32
sraw r0,r2,r31
ble $+8
ori r3,r0,0
sraw r2,r2,r6
```

Shift Right Algebraic, $n = 3$ (Shift Amount < 32)

```
subfic r31,r6,32
srw r4,r4,r6
slw r0,r3,r31
or r4,r4,r0
srw r3,r3,r6
slw r0,r2,r31
or r3,r3,r0
sraw r2,r2,r6
```

appear to the low-order side of the R bit, due to either shifting the accumulator right or to other generation of low-order result bits. The G and R bits participate in the left shifts with zeros being shifted into the R bit.

Table D-1 shows the significance of the G, R, and X bits with respect to the intermediate result (IR), the next lower in magnitude representable number (NL), and the next higher in magnitude representable number (NH).

Table D-1. Interpretation of G, R, and X Bits

G	R	X	Interpretation
0	0	0	IR is exact
0	0	1	IR closer to NL
0	1	0	
0	1	1	
1	0	0	IR midway between NL & NH
1	0	1	IR closer to NH
1	1	0	
1	1	1	

The significand of the intermediate result is made up of the L bit, the FRACTION, and the G, R, and X bits.

The infinitely precise intermediate result of an operation is the result normalized in bits L, FRACTION, G, R, and X of the floating-point accumulator.

After normalization, the intermediate result is rounded, using the rounding mode specified by FPSCR[RN]. If rounding causes a carry into C, the significand is shifted right one position and the exponent is incremented by one. This causes an inexact result and possibly exponent overflow. Fraction bits to the left of the bit position used for rounding are stored into the FPR, and low-order bit positions, if any, are set to zero.

Four user-selectable rounding modes are provided through FPSCR[RN] as described in Section 3.3.5, "Rounding." For rounding, the conceptual guard, round, and sticky bits are defined in terms of accumulator bits.

Table D-2 shows the positions of the guard, round, and sticky bits for double-precision and single-precision floating-point numbers in the IEEE execution model.

Table D-2. Location of the Guard, Round, and Sticky Bits—IEEE Execution Model

Format	Guard	Round	Sticky
Double	G bit	R bit	X bit
Single	24	25	OR of 26–52 G,R,X

Rounding can be treated as though the significand were shifted right, if required, until the least-significant bit to be retained is in the low-order bit position of the FRACTION. If any of the guard, round, or sticky bits are nonzero, the result is inexact.

Z1 and Z2, defined in Section 3.3.5, “Rounding,” can be used to approximate the result in the target format when one of the following rules is used:

- Round to nearest
 - Guard bit = 0: The result is truncated. (Result exact (GRX = 000) or closest to next lower value in magnitude (GRX = 001, 010, or 011).
 - Guard bit = 1: Depends on round and sticky bits:
 - Case a: If the round or sticky bit is one (inclusive), the result is incremented (result closest to next higher value in magnitude (GRX = 101, 110, or 111)).
 - Case b: If the round and sticky bits are zero (result midway between closest representable values) then if the low-order bit of the result is one, the result is incremented. Otherwise (the low-order bit of the result is zero) the result is truncated (this is the case of a tie rounded to even).
- If during the round-to-nearest process, truncation of the unrounded number produces the maximum magnitude for the specified precision, the following action is taken:
 - Guard bit = 1: Store infinity with the sign of the unrounded result.
 - Guard bit = 0: Store the truncated (maximum magnitude) value.
- Round toward zero—Choose the smaller in magnitude of Z1 or Z2. If the guard, round, or sticky bit is nonzero, the result is inexact.
- Round toward +infinity—Choose Z1.
- Round toward -infinity—Choose Z2.

Where the result is to have fewer than 53 bits of precision because the instruction is a floating round to single-precision or single-precision arithmetic instruction, the intermediate result either is normalized or is placed in correct denormalized form before being rounded.

D.2 Execution Model for Multiply-Add Type Instructions

The PowerPC architecture makes use of a special instruction form that performs up to three operations in one instruction (a multiply, an add, and a negate). With this added capability comes the special ability to produce a more exact intermediate result as an input to the rounder. Single-precision arithmetic is similar except that the fraction field is smaller. Note that the rounding occurs only after add; therefore, the computation of the sum and product together are infinitely precise before the final result is rounded to a representable format.

The multiply-add significand arithmetic is considered to be performed with a floating-point accumulator, where bits 1–106 comprise the significand of the intermediate result. The format is shown in Figure D-2.



Figure D-2. Multiply-Add 64-Bit Execution Model

The first part of the operation is a multiply. The multiply has two 53-bit significands as inputs, which are assumed to be prenormalized, and produces a result conforming to the above model. If there is a carry out of the significand (into the C bit), the significand is shifted right one position, placing the L bit into the most-significant bit of the FRACTION and placing the C bit into the L bit. All 106 bits (L bit plus the fraction) of the product take part in the add operation. If the exponents of the two inputs to the adder are not equal, the significand of the operand with the smaller exponent is aligned (shifted) to the right by an amount added to that exponent to make it equal to the other input's exponent. Zeros are shifted into the left of the significand as it is aligned and bits shifted out of bit 105 of the significand are ORed into the X' bit. The add operation also produces a result conforming to the above model with the X' bit taking part in the add operation.

The result of the add is then normalized, with all bits of the add result, except the X' bit, participating in the shift. The normalized result serves as the intermediate result that is input to the rounder.

For rounding, the conceptual guard, round, and sticky bits are defined in terms of accumulator bits. Table D-3 shows the positions of the guard, round, and sticky bits for double-precision and single-precision floating-point numbers in the multiply-add execution model.

Table D-3. Location of the Guard, Round, and Sticky Bits—Multiply-Add Execution Model

Format	Guard	Round	Sticky
Double	53	54	OR of 55–105, X'
Single	24	25	OR of 26–105, X'

The rules for rounding the intermediate result are the same as those given in Section D.1, “Execution Model for IEEE Operations.”

If the instruction is floating negative multiply-add or floating negative multiply-subtract, the final result is negated.

Floating-point multiply-add instructions combine a multiply and an add operation without an intermediate rounding operation. The fraction part of the intermediate product is 106 bits wide, and all 106 bits take part in the add/subtract portion of the instruction.

Status bits are set as follows:

- Overflow, underflow, and inexact exception bits, the FR and FI bits, and the FPRF field are set based on the final result of the operation, and not on the result of the multiplication.
- Invalid operation exception bits are set as if the multiplication and the addition were performed using two separate instructions (for example, an **fmul** instruction followed by an **fadd** instruction). That is, multiplication of infinity by 0 or of anything by an SNaN, causes the corresponding exception bits to be set.

D.3 Floating-Point Conversions

This section provides examples of floating-point conversion instructions. Note that some of the examples use the optional Floating Select (**fsel**) instruction. Care must be taken in using **fsel** if IEEE compatibility is required, or if the values being tested can be NaNs or infinities.

D.3.1 Conversion from Floating-Point Number to Floating-Point Integer

In a 64-bit implementation, the full convert to floating-point integer function can be implemented with the following sequence assuming the floating-point value to be converted is in FPR1, and the result is returned in FPR3.

```
mtfsb0 23      #clear VXCVI
fctid[z]f3,f1  #convert to fx int
fcfid  f3,f3   #convert back again
mcrfs  7,5     #VXCVI to CR
bf     31,$+8  #skip if VXCVI was 0
fmr    f3,f1   #input was fp int
```

D.3.2 Conversion from Floating-Point Number to Signed Fixed-Point Integer Double Word

This example applies to 64-bit implementations only.

The full convert to signed fixed-point integer double word function can be implemented with the following sequence, assuming the floating-point value to be converted is in FPR1, the result is returned in GPR3, and a double word at displacement (disp) from the address in GPR1 can be used as scratch space.

```
fctid[z]f2,f1      #convert to dword int
stfd    f2,disp(r1) #store float
ld      r3,disp(r1) #load dword
```

D.3.3 Conversion from Floating-Point Number to Unsigned Fixed-Point Integer Double Word

This example applies to 64-bit implementations only.

The full convert to unsigned fixed-point integer double word function can be implemented with the following sequence, assuming the floating-point value to be converted is in FPR1, the value zero is in FPR0, the value $2^{64} - 2048$ is in FPR3, the value 2^{63} is in FPR4 and GPR4, the result is returned in GPR3, and a double word at displacement (disp) from the address in GPR1 can be used as scratch space.

```
fsel    f2,f1,f1,f0 #use 0 if < 0
fsub    f5,f3,f1     #use max if > max
fsel    f2,f5,f2,f3
fsub    f5,f2,f4     #subtract 2**63
fcmplu  cr2,f2,f4    #use diff if ≥ 2**63
fsel    f2,f5,f5,f2
fctid[z]f2,f2      #convert to fx int
stfd    f2,disp(r1) #store float
ld      r3,disp(r1) #load dword
blt     cr2,$+8     #add 2**63 if input
add     r3,r3,r4    #was ≥ 2**63
```

D.3.4 Conversion from Floating-Point Number to Signed Fixed-Point Integer Word

The full convert to signed fixed-point integer word function can be implemented with the following sequence, assuming that the floating-point value to be converted is in FPR1, the result is returned in GPR3, and a double word at displacement (disp) from the address in GPR1 can be used as scratch space.

```
fctiw[z]f2,f1     #convert to fx int
stfd    f2,disp(r1) #store float
lwa     r3,disp + 4(r1) #load word algebraic
                                     #(use lwz on a 32-bit implementation)
```

D.3.5 Conversion from Floating-Point Number to Unsigned Fixed-Point Integer Word

In a 64-bit implementation, the full convert to unsigned fixed-point integer word function can be implemented with the following sequence, assuming the floating-point value to be converted is in FPR1, the value zero is in FPR0, the value $2^{32} - 1$ is in FPR3, the result is returned in GPR3, and a double word at displacement (disp) from the address in GPR1 can be used as scratch space.

```
fsel    f2,f1,f1,f0    #use 0 if < 0
fsub    f4,f3,f1      #use max if > max
fsel    f2,f4,f2,f3
fctid[z]f2,f2        #convert to fx int
stfd    f2,disp(r1)  #store float
lwz     r3,disp + 4(r1) #load word and zero
```

In a 32-bit implementation, the full convert to unsigned fixed-point integer word function can be implemented with the sequence shown below, assuming that the floating-point value to be converted is in FPR1, the value zero is in FPR0, the value $2^{32} - 1$ is in FPR3, the value 2^{31} is in FPR4, the result is returned in GPR3, and a double word at displacement (disp) from the address in GPR1 can be used as scratch space.

```
fsel    f2,f1,f1,f0    #use 0 if < 0
fsub    f5,f3,f1      #use max if > max
fsel    f2,f5,f2,f3
fsub    f5,f2,f4      #subtract 2**31
fcmphu  cr2,f2,f4     #use diff if ≥ 2**31
fsel    f2,f5,f5,f2
fctiw[z]f2,f2        #convert to fx int
stfd    f2,disp(r1)  #store float
lwz     r3,disp + 4(r1) #load word
blt     cr2,$+8      #add 2**31 if input
xoriss  r3,r3,0x8000  #was ≥ 2**31
```

D.3.6 Conversion from Signed Fixed-Point Integer Double Word to Floating-Point Number

This example applies to 64-bit implementations only.

The full convert from signed fixed-point integer double word function, using the rounding mode specified by FPSCR[RN], can be implemented with the following sequence, assuming the fixed-point value to be converted is in GPR3, the result is returned in FPR1, and a double word at displacement (disp) from the address in GPR1 can be used as scratch space.

```
std     r3,disp(r1)  #store dword
lfd     f1,disp(r1)  #load float
fcfid   f1,f1        #convert to fpu int
```

D.3.7 Conversion from Unsigned Fixed-Point Integer Double Word to Floating-Point Number

This example applies to 64-bit implementations only.

The full convert from unsigned fixed point integer double word function, using the rounding mode specified by FPSCR[RN], can be implemented with the following sequence, assuming the fixed-point value to be converted is in GPR3, the value 2^{32} is in FPR4, the result is returned in FPR1, and two double words at displacement (disp) from the address in GPR1 is used as scratch space.

```
rldicl r2,r3,32,32    #isolate high half
rldicl r0,r3,0,32    #isolate low half
std    r2,disp(r1)   #store dword both
std    r0,disp + 8(r1)
lfd    f2,disp(r1)   #load float both
lfd    f1,disp + 8(r1) #load float both
fcfid  f2,f2         #convert each half to
fcfid  f1,f1         #fpu int (no rnd)
fmadd  f1,f4,f2,f1   #(2**32)*high+low
                    (only add can rnd)
```

An alternative, shorter, sequence can be used if rounding according to FPSCR[RN] is desired and FPSCR[RN] specifies round toward +infinity or round toward -infinity, or if it is acceptable for the rounded answer to be either of the two representable floating-point integers nearest to the given fixed-point integer. In this case the full convert from unsigned fixed-point integer double word function can be implemented with the following sequence, assuming the value 2^{64} is in FPR2.

```
std    r3,disp(r1)   #store dword
lfd    f1,disp(r1)   #load float
fcfid  f1,f1         #convert to fpu int
fadd   f4,f1,f2      #add 2**64
fsel   f1,f1,f1,f4   #if r3 < 0
```

D.3.8 Conversion from Signed Fixed-Point Integer Word to Floating-Point Number

In a 64-bit implementation, the full convert from signed fixed-point integer word function can be implemented with the following sequence, assuming the fixed-point value to be converted is in GPR3, the result is returned in FPR1, and a double word at displacement (disp) from the address in GPR1 can be used as scratch space. (The result is exact.)

```
extsw  r3,r3         #extend sign
std    r3,disp(r1)   #store dword
lfd    f1,disp(r1)   #load float
fcfid  f1,f1         #convert to fpu int
```

D.3.9 Conversion from Unsigned Fixed-Point Integer Word to Floating-Point Number

In a 64-bit implementation, the full convert from unsigned fixed-point integer word function can be implemented with the following sequence, assuming the fixed-point value to be converted is in GPR3, the result is returned in FPR1, and a double word at displacement (disp) from the address in GPR1 can be used as scratch space. (The result is exact.)

```
rldicl  r0,r3,0,32      #zero-extend
std     r0,disp(r1)     #store dword
lfd     f1,disp(r1)     #load float
fcfid  f1,f1           #convert to fpu int
```

D.4 Floating-Point Models

This section describes models for floating-point instructions.

D.4.1 Floating-Point Round to Single-Precision Model

The following algorithm describes the operation of the Floating Round to Single-Precision (**frsp**) instruction.

```
If frB[1-11] < 897 and frB[1-63] > 0 then
  Do
    If FPSCR[UE] = 0 then goto Disabled Exponent Underflow
    If FPSCR[UE] = 1 then goto Enabled Exponent Underflow
  End

If frB[1-11] > 1150 and frB[1-11] < 2047 then
  Do
    If FPSCR[OE] = 0 then goto Disabled Exponent Overflow
    If FPSCR[OE] = 1 then goto Enabled Exponent Overflow
  End

If frB[1-11] > 896 and frB[1-11] < 1151 then goto Normal Operand

If frB[1-63] = 0 then goto Zero Operand

If frB[1-11] = 2047 then
  Do
    If frB[12-63] = 0 then goto Infinity Operand
    If frB[12] = 1 then goto QNaN Operand
    If frB[12] = 0 and frB[13-63] > 0 then goto SNaN Operand
  End
```

Disabled Exponent Underflow:

```
sign ← frB[0]
If frB[1-11] = 0 then
  Do
    exp ← -1022
    frac[0-52] ← 0b0 || frB[12-63]
  End
If frB[1-11] > 0 then
  Do
    exp ← frB[1-11] - 1023
    frac[0-52] ← 0b1 || frB[12-63]
  End
Denormalize operand:
G || R || X ← 0b000
Do while exp < -126
```

```

    exp ← exp + 1
    frac[0–52] || G || R || X ← 0b0 || frac || G || (R | X)
  End
FPSCR[UX] ← frac[24–52] || G || R || X > 0
Round single(sign,exp,frac[0–52],G,R,X)
FPSCR[XX] ← FPSCR[XX] | FPSCR[FI]
If frac[0–52] = 0 then
  Do
    frD[0] ← sign
    frD[1–63] ← 0
    If sign = 0 then FPSCR[FPRF] ← “+zero”
    If sign = 1 then FPSCR[FPRF] ← “-zero”
  End
If frac[0–52] > 0 then
  Do
    If frac[0] = 1 then
      Do
        If sign = 0 then FPSCR[FPRF] ← “+normal number”
        If sign = 1 then FPSCR[FPRF] ← “-normal number”
      End
    If frac[0] = 0 then
      Do
        If sign = 0 then FPSCR[FPRF] ← “+denormalized number”
        If sign = 1 then FPSCR[FPRF] ← “-denormalized number”
      End
    Normalize operand:
    Do while frac[0] = 0
      exp ← exp - 1
      frac[0–52] ← frac[1–52] || 0b0
    End
    frD[0] ← sign
    frD[1–11] ← exp + 1023
    frD[12–63] ← frac[1–52]
  End
End
Done

```

Enabled Exponent Underflow

```

FPSCR[UX] ← 1
sign ← frB[0]
If frB[1–11] = 0 then
  Do
    exp ← -1022
    frac[0–52] ← 0b0 || frB[12–63]
  End
If frB[1–11] > 0 then
  Do
    exp ← frB[1–11] - 1023
    frac[0–52] ← 0b1 || frB[12–63]
  End

Normalize operand:
Do while frac[0] = 0
  exp ← exp - 1
  frac[0–52] ← frac[1–52] || 0b0
End
Round single(sign,exp,frac[0–52],0,0,0)
FPSCR[XX] ← FPSCR[XX] | FPSCR[FI]
exp ← exp + 192
frD[0] ← sign
frD[1–11] ← exp + 1023
frD[12–63] ← frac[1–52]
If sign = 0 then FPSCR[FPRF] ← “+normal number”
If sign = 1 then FPSCR[FPRF] ← “-normal number”
Done

```

Disabled Exponent Overflow

```
FPSCR[OX] ← 1
If FPSCR[RN] = 0b00 then      /* Round to Nearest */
  Do
    If frB[0] = 0 then frD ← 0x7FF0_0000_0000_0000
    If frB[0] = 1 then frD ← 0xFFF0_0000_0000_0000
    If frB[0] = 0 then FPSCR[FPRF] ← “+infinity”
    If frB[0] = 1 then FPSCR[FPRF] ← “-infinity”
  End
If FPSCR[RN] = 0b01 then      /* Round Truncate */
  Do
    If frB[0] = 0 then frD ← 0x47EF_FFFF_E000_0000
    If frB[0] = 1 then frD ← 0xC7EF_FFFF_E000_0000
    If frB[0] = 0 then FPSCR[FPRF] ← “+normal number”
    If frB[0] = 1 then FPSCR[FPRF] ← “-normal number”
  End
If FPSCR[RN] = 0b10 then      /* Round to +Infinity */
  Do
    If frB[0] = 0 then frD ← 0x7FF0_0000_0000_0000
    If frB[0] = 1 then frD ← 0xC7EF_FFFF_E000_0000
    If frB[0] = 0 then FPSCR[FPRF] ← “+infinity”
    If frB[0] = 1 then FPSCR[FPRF] ← “-normal number”
  End
If FPSCR[RN] = 0b11 then      /* Round to -Infinity */
  Do
    If frB[0] = 0 then frD ← 0x47EF_FFFF_E000_0000
    If frB[0] = 1 then frD ← 0xFFF0_0000_0000_0000
    If frB[0] = 0 then FPSCR[FPRF] ← “+normal number”
    If frB[0] = 1 then FPSCR[FPRF] ← “-infinity”
  End
FPSCR[FR] ← undefined
FPSCR[FI] ← 1
FPSCR[XX] ← 1
Done
```

Enabled Exponent Overflow

```
sign ← frB[0]
exp ← frB[1-11] - 1023
frac[0-52] ← 0b1 || frB[12-63]
Round single(sign,exp,frac[0-52],0,0,0)
FPSCR[XX] ← FPSCR[XX] | FPSCR[FI]
Enabled Overflow
FPSCR[OX] ← 1
exp ← exp - 192
frD[0] ← sign
frD[1-11] ← exp + 1023
frD[12-63] ← frac[1-52]
If sign = 0 then FPSCR[FPRF] ← “+normal number”
If sign = 1 then FPSCR[FPRF] ← “-normal number”
Done
```

Zero Operand

```
frD ← frB
If frB[0] = 0 then FPSCR[FPRF] ← “+zero”
If frB[0] = 1 then FPSCR[FPRF] ← “-zero”
FPSCR[FR FI] ← 0b00
Done
```

Infinity Operand

```
frD ← frB
If frB[0] = 0 then FPSCR[FPRF] ← “+infinity”
If frB[0] = 1 then FPSCR[FPRF] ← “-infinity”
Done
```

QNaN Operand:

```
frD ← frB[0–34] || 0b0_0000_0000_0000_0000_0000_0000_0000
FPSCR[FPRF] ← “QNaN”
FPSCR[FR FI] ← 0b00
Done
```

SNaN Operand

```
FPSCR[VXSNAN] ← 1
If FPSCR[VE] = 0 then
  Do
    frD[0–11] ← frB[0–11]
    frD[12] ← 1
    frD[13–63] ← frB[13–34] || 0b0_0000_0000_0000_0000_0000_0000_0000
    FPSCR[FPRF] ← “QNaN”
  End
FPSCR[FR FI] ← 0b00
Done
```

Normal Operand

```
sign ← frB[0]
exp ← frB[1–11] - 1023
frac[0–52] ← 0b1 || frB[12–63]
Round single(sign, exp, frac[0–52], 0, 0, 0)
FPSCR[XX] ← FPSCR[XX] | FPSCR[FI]
If exp > +127 and FPSCR[OE] = 0 then go to Disabled Exponent Overflow
If exp > +127 and FPSCR[OE] = 1 then go to Enabled Overflow
frD[0] ← sign
frD[1–11] ← exp + 1023
frD[12–63] ← frac[1–52]
If sign = 0 then FPSCR[FPRF] ← “+normal number”
If sign = 1 then FPSCR[FPRF] ← “-normal number”
Done
```

Round Single (sign,exp,frac[0–52],G,R,X)

```
inc ← 0
lsb ← frac[23]
gbit ← frac[24]
rbit ← frac[25]
xbit ← (frac[26–52] || G || R || X) ≠ 0
If FPSCR[RN] = 0b00 then
  Do
    If sign || lsb || gbit || rbit || xbit = 0b11uu then inc ← 1
    If sign || lsb || gbit || rbit || xbit = 0bu01u then inc ← 1
    If sign || lsb || gbit || rbit || xbit = 0bu01u1 then inc ← 1
  End
If FPSCR[RN] = 0b10 then
  Do
    If sign || lsb || gbit || rbit || xbit = 0b0u1uu then inc ← 1
    If sign || lsb || gbit || rbit || xbit = 0b0uu1u then inc ← 1
    If sign || lsb || gbit || rbit || xbit = 0b0uuu1 then inc ← 1
  End
If FPSCR[RN] = 0b11 then
  Do
    If sign || lsb || gbit || rbit || xbit = 0b1u1uu then inc ← 1
    If sign || lsb || gbit || rbit || xbit = 0b1uu1u then inc ← 1
    If sign || lsb || gbit || rbit || xbit = 0b1uuu1 then inc ← 1
  End
frac[0–23] ← frac[0–23] + inc
If carry_out = 1 then
  Do
    frac[0–23] ← 0b1 || frac[0–22]
    exp ← exp + 1
  End
```



```

frac[24–52] ← (29)0
FPSCR[FR] ← inc
FPSCR[FI] ← gbit | rbit | xbit
Return

```

D.4.2 Floating-Point Convert to Integer Model

The following algorithm describes the operation of the floating-point convert to integer instructions. In this example, ‘u’ represents an undefined hexadecimal digit.

```

If Floating Convert to Integer Word
  Then Do
    Then round_mode ← FPSCR[RN]
    tgt_precision ← “32-bit integer”
  End
If Floating Convert to Integer Word with round toward Zero
  Then Do
    round_mode ← 0b01
    tgt_precision ← “32-bit integer”
  End
If Floating Convert to Integer Double Word
  Then Do
    round_mode ← FPSCR[RN]
    tgt_precision ← “64-bit integer”
  End
If Floating Convert to Integer Double Word with Round toward Zero
  Then Do
    round_mode ← 0b01
    tgt_precision ← “64-bit integer”
  End
sign ← frB[0]
If frB[1–11] = 2047 and frB[12–63] = 0 then goto Infinity Operand
If frB[1–11] = 2047 and frB[12] = 0 then goto SNaN Operand
If frB[1–11] = 2047 and frB[12] = 1 then goto QNaN Operand
If frB[1–11] > 1054 then goto Large Operand

If frB[1–11] > 0 then exp ← frB[1–11] – 1023 /* exp – bias */
If frB[1–11] = 0 then exp ← –1022
If frB[1–11] > 0 then frac[0–64] ← 0b01 || frB[12–63] || (11)0 /*normal*/
If frB[1–11] = 0 then frac[0–64] ← 0b00 || frB[12–63] || (11)0 /*denormal*/

gbit || rbit || xbit ← 0b000
Do i = 1, 63 – exp /*do the loop 0 times if exp = 63*/
  frac[0–64] || gbit || rbit || xbit ← 0b0 || frac[0–64] || gbit || (rbit | xbit)
End

```

Round Integer (sign,frac[0–64],gbit,rbit,xbit,round_mode)

In this example, ‘u’ represents an undefined hexadecimal digit. Comparisons ignore the u bits.

```

If sign = 1 then frac[0–64] ← ¬frac[0–64] + 1 /* needed leading 0 for –264 < frB < –263*/

If tgt_precision = “32-bit integer” and frac[0–64] > +231 – 1
  then goto Large Operand
If tgt_precision = “64-bit integer” and frac[0–64] > +263 – 1
  then goto Large Operand
If tgt_precision = “32-bit integer” and frac[0–64] < –231 then goto Large Operand
FPSCR[XX] ← FPSCR[XX] | FPSCR[FI]

```

```

If tgt_precision = "64-bit integer" and frac[0-64] < -263 then goto Large Operand
If tgt_precision = "32-bit integer"
    then frD ← 0xuuu_uuuu || frac[33-64]
If tgt_precision = "64-bit integer" then frD ← frac[1-64]
FPSCR[FPRF] ← undefined
Done

```

Round Integer(sign,frac[0-64],gbit,rbit,xbit,round_mode)

In this example, 'u' represents an undefined hexadecimal digit. Comparisons ignore the u bits.

```

inc ← 0
If round_mode = 0b00 then
    Do
        If sign || frac[64] || gbit || rbit || xbit = 0bu11uu then inc ← 1
        If sign || frac[64] || gbit || rbit || xbit = 0bu011u then inc ← 1
        If sign || frac[64] || gbit || rbit || xbit = 0bu01u1 then inc ← 1
    End
If round_mode = 0b10 then
    Do
        If sign || frac[64] || gbit || rbit || xbit = 0b0u1uu then inc ← 1
        If sign || frac[64] || gbit || rbit || xbit = 0b0uu1u then inc ← 1
        If sign || frac[64] || gbit || rbit || xbit = 0b0uuu1 then inc ← 1
    End
If round_mode = 0b11 then
    Do
        If sign || frac[64] || gbit || rbit || xbit = 0b1u1uu then inc ← 1
        If sign || frac[64] || gbit || rbit || xbit = 0b1uu1u then inc ← 1
        If sign || frac[64] || gbit || rbit || xbit = 0b1uuu1 then inc ← 1
    End
frac[0-64] ← frac[0-64] + inc
FPSCR[FR] ← inc
FPSCR[FI] ← gbit | rbit | xbit
Return

```

Infinity Operand

```

FPSCR[FR FI VXCVI] ← 0b001
If FPSCR[VE] = 0 then Do
    If tgt_precision = "32-bit integer" then
        Do
            If sign = 0 then frD ← 0xuuuu_uuuu_7FFF_FFFF
            If sign = 1 then frD ← 0xuuuu_uuuu_8000_0000
        End
    Else
        Do
            If sign = 0 then frD ← 0x7FFF_FFFF_FFFF_FFFF
            If sign = 1 then frD ← 0x8000_0000_0000_0000
        End
    FPSCR[FPRF] ← undefined
End
Done

```

SNaN Operand

```

FPSCR[FR FI VXCVI VXSNaN] ← 0b0011
If FPSCR[VE] = 0 then
    Do
        If tgt_precision = "32-bit integer"
            then frD ← 0xuuuu_uuuu_8000_0000
        If tgt_precision = "64-bit integer"
            then frD ← 0x8000_0000_0000_0000
        FPSCR[FPRF] ← undefined
    End
Done

```

QNaN Operand

```
FPSCR[FR FI VXCVI] ← 0b001
If FPSCR[VE] = 0 then
  Do
    If tgt_precision = "32-bit integer" then frD ← 0xuuuu_uuuu_8000_0000
    If tgt_precision = "64-bit integer" then frD ← 0x8000_0000_0000_0000
    FPSCR[FPRF] ← undefined
  End
Done
```

Large Operand

```
FPSCR[FR FI VXCVI] ← 0b001
If FPSCR[VE] = 0 then Do
  If tgt_precision = "32-bit integer" then
    Do
      If sign = 0 then frD ← 0xuuuu_uuuu_7FFF_FFFF
      If sign = 1 then frD ← 0xuuuu_uuuu_8000_0000
    End
  Else
    Do
      If sign = 0 then frD ← 0x7FFF_FFFF_FFFF_FFFF
      If sign = 1 then frD ← 0x8000_0000_0000_0000
    End
  FPSCR[FPRF] ← undefined
End
Done
```

D.4.3 Floating-Point Convert from Integer Model

The following describes, algorithmically, the operation of the floating-point convert from integer instructions.

```
sign ← frB[0]
exp ← 63
frac[0–63] ← frB

If frac[0–63] = 0 then go to Zero Operand

If sign = 1 then frac[0–63] ← ¬frac[0–63] + 1

Do while frac[0] = 0
  frac[0–63] ← frac[1–63] || '0'
  exp ← exp – 1
End
```

Round Float(sign,exp,frac[0–63],FPSCR[RN])

```
If sign = 1 then FPSCR[FPRF] ← "–normal number"
If sign = 0 then FPSCR[FPRF] ← "+normal number"
frD[0] ← sign
frD[1–11] ← exp + 1023
frD[12–63] ← frac[1–52]
Done
```

Zero Operand

```
FPSCR[FR FI] ← 0b00
FPSCR[FPRF] ← "+zero"
frD ← 0x0000_0000_0000_0000
Done
```

Round Float(sign,exp,frac[0–63],round_mode)

In this example ‘u’ represents an undefined hexadecimal digit. Comparisons ignore the u bits.

```
inc ← 0
lsb ← frac[52]
gbit ← frac[53]
rbit ← frac[54]
xbit ← frac[55–63] > 0
If round_mode = 0b00 then
  Do
    If sign || lsb || gbit || rbit || xbit = 0bu11uu then inc ← 1
    If sign || lsb || gbit || rbit || xbit = 0bu011u then inc ← 1
    If sign || lsb || gbit || rbit || xbit = 0bu01u1 then inc ← 1
  End
If round_mode = 0b10 then
  Do
    If sign || lsb || gbit || rbit || xbit = 0b0u1uu then inc ← 1
    If sign || lsb || gbit || rbit || xbit = 0b0uu1u then inc ← 1
    If sign || lsb || gbit || rbit || xbit = 0b0uuu1 then inc ← 1
  End
If round_mode = 0b11 then
  Do
    If sign || lsb || gbit || rbit || xbit = 0b1u1uu then inc ← 1
    If sign || lsb || gbit || rbit || xbit = 0b1uu1u then inc ← 1
    If sign || lsb || gbit || rbit || xbit = 0b1uuu1 then inc ← 1
  End
frac[0–52] ← frac[0–52] + inc
If carry_out = 1 then exp ← exp + 1
FPSCR[FR] ← inc
FPSCR[FI] ← gbit | rbit | xbit
FPSCR[XX] ← FPSCR[XX] | FPSCR[FI]
Return
```

D.5 Floating-Point Selection

The following are examples of how the optional **fsel** instruction can be used to implement floating-point minimum and maximum functions, and certain simple forms of if-then-else constructions, without branching.

The examples show program fragments in an imaginary, C-like, high-level programming language, and the corresponding program fragment using **fsel** and other PowerPC instructions. In the examples, *a*, *b*, *x*, *y*, and *z* are floating-point variables, which are assumed to be in FPRs *fa*, *fb*, *fx*, *fy*, and *fz*. FPR *fs* is assumed to be available for scratch space.

Additional examples can be found in Section D.3, “Floating-Point Conversions.”

Note that care must be taken in using **fsel** if IEEE compatibility is required, or if the values being tested can be NaNs or infinities; see Section D.5.4, “Notes.”

D.5.1 Comparison to Zero

This section provides examples in a program fragment code sequence for the comparison to zero case.

High-level language:

```
if a ≥ 0.0 then x ← y
    else x ← z
```

```
if a > 0.0 then x ← y
    else x ← z
```

```
if a = 0.0 then x ← y
    else x ← z
```

PowerPC:

fsel fx, fa, fy, fz (see Section D.5.4, “Notes” number 1)

fneg fs, fa

fsel fx, fs, fz, fy (see Section D.5.4, “Notes” numbers 1 and 2)

fsel fx, fa, fy, fz

fneg fs, fa

fsel fx, fs, fx, fz (see Section D.5.4, “Notes” number 1)

D.5.2 Minimum and Maximum

This section provides examples in a program fragment code sequence for the minimum and maximum cases.

High-level language:

```
x ← min(a, b)
```

```
x ← max(a, b)
```

PowerPC:

fsub fs, fa, fb (see Section D.5.4, “Notes” numbers 3, 4, and 5)

fsel fx, fs, fb, fa

fsub fs, fa, fb (see Section D.5.4, “Notes” numbers 3, 4, and 5)

fsel fx, fs, fa, fb

D.5.3 Simple If-Then-Else Constructions

This section provides examples in a program fragment code sequence for simple if-then-else statements.

High-level language:

```
if a ≥ b then x ← y
    else x ← z
```

```
if a > b then x ← y
    else x ← z
```

```
if a = b then x ← y
    else x ← z
```

PowerPC:

fsub fs, fa, fb

fsel fx, fs, fy, fz (see Section D.5.4, “Notes” numbers 4 and 5)

fsub fs, fb, fa

fsel fx, fs, fz, fy (see Section D.5.4, “Notes” numbers 3, 4, and 5)

fsub fs, fa, fb

fsel fx, fs, fy, fz

fneg fs, fs

fsel fx, fs, fx, fz (see Section D.5.4, “Notes” numbers 4 and 5)

D.5.4 Notes

The following notes apply to the examples found in Section D.5.1, “Comparison to Zero,” Section D.5.2, “Minimum and Maximum,” and Section D.5.3, “Simple If-Then-Else Constructions,” and to the corresponding cases using the other three arithmetic relations (<, ≤, and ≠). These notes should also be considered when any other use of **fsel** is contemplated.

In these notes the “optimized program” is the PowerPC program shown, and the “unoptimized program” (not shown) is the corresponding PowerPC program that uses **fcmpl** and branch conditional instructions instead of **fsl**.

1. The unoptimized program affects the VXSNaN bit of the FPSCR, and therefore may cause the system error handler to be invoked if the corresponding exception is enabled, while the optimized program does not affect this bit. This property of the optimized program is incompatible with the IEEE standard. (Note that the architecture specification also refers to exceptions as interrupts.)
2. The optimized program gives the incorrect result if ‘a’ is a NaN.
3. The optimized program gives the incorrect result if ‘a’ and/or ‘b’ is a NaN (except that it may give the correct result in some cases for the minimum and maximum functions, depending on how those functions are defined to operate on NaNs).
4. The optimized program gives the incorrect result if ‘a’ and ‘b’ are infinities of the same sign. (Here it is assumed that invalid operation exceptions are disabled, in which case the result of the subtraction is a NaN. The analysis is more complicated if invalid operation exceptions are enabled, because in that case the target register of the subtraction is unchanged.)
5. The optimized program affects the OX, UX, XX, and VXISI bits of the FPSCR, and therefore may cause the system error handler to be invoked if the corresponding exceptions are enabled, while the unoptimized program does not affect these bits. This property of the optimized program is incompatible with the IEEE standard.

D.6 Floating-Point Load Instructions

There are two basic forms of load instruction—single-precision and double-precision. Because the FPRs support only floating-point double format, single-precision load floating-point instructions convert single-precision data to double-precision format prior to loading the operands into the target FPR. The conversion and loading steps follow:

Let WORD[0–31] be the floating point single-precision operand accessed from memory.

Normalized Operand

```
If WORD[1-8] > 0 and WORD[1-8] < 255
    frD[0-1] ← WORD[0-1]
    frD[2] ← ¬ WORD[1]
    frD[3] ← ¬ WORD[1]
    frD[4] ← ¬ WORD[1]
    frD[5-63] ← WORD[2-31] || (29)0
```

Denormalized Operand

```
If WORD[1-8] = 0 and WORD[9-31] ≠ 0
    sign ← WORD[0]
    exp ← -126
    frac[0-52] ← 0b0 || WORD[9-31] || (29)0
    normalize the operand
    Do while frac[0] = 0
        frac ← frac[1-52] || 0b0
```

```

    exp ← exp - 1
  End
  frD[0] ← sign
  frD[1-11] ← exp + 1023
  frD[12-63] ← frac[1-52]

```

Infinity / QNaN / SNaN / Zero

```

If WORD[1-8] = 255 or WORD[1-31] = 0
  frD[0-1] ← WORD[0-1]
  frD[2] ← WORD[1]
  frD[3] ← WORD[1]
  frD[4] ← WORD[1]
  frD[5-63] ← WORD[2-31] || (29)0

```

For double-precision floating-point load instructions, no conversion is required as the data from memory is copied directly into the FPRs.

Many floating-point load instructions have an update form in which register **rA** is updated with the EA. For these forms, if operand **rA** ≠ 0, the effective address (EA) is placed into register **rA** and the memory element (word or double word) addressed by the EA is loaded into the floating-point register specified by operand **frD**; if operand **rA** = 0, the instruction form is invalid.

Recall that **rA**, **rB**, and **rD** denote GPRs, while **frA**, **frB**, **frC**, **frS**, and **frD** denote FPRs.

D.7 Floating-Point Store Instructions

There are three basic forms of store instruction—single-precision, double-precision, and integer. The integer form is provided by the optional **stfiwx** instruction. Because the FPRs support only floating-point double format for floating-point data, single-precision store floating-point instructions convert double-precision data to single-precision format prior to storing the operands into memory. The conversion steps follow:

Let WORD[0–31] be the word written to in memory.

No Denormalization Required (includes Zero/Infinity/NaN)

```

if frS[1-11] > 896 or frS[1-63] = 0 then
  WORD[0-1] ← frS[0-1]
  WORD[2-31] ← frS[5-34]

```

Denormalization Required

```

if 874 ≤ frS[1-11] ≤ 896 then
  sign ← frS[0]
  exp ← frS[1-11] - 1023
  frac ← 0b1 || frS[12-63]
  Denormalize operand
    Do while exp < -126
      frac ← 0b0 || frac[0-62]
      exp ← exp + 1
    End
  WORD[0] ← sign
  WORD[1-8] ← 0x00
  WORD[9-31] ← frac[1-23]
else WORD ← undefined

```

Notice that if the value to be stored by a single-precision store floating-point instruction is larger in magnitude than the maximum number representable in single format, the first case mentioned, “No Denormalization Required,” applies. The result stored in WORD is then a well-defined value, but is not numerically equal to the value in the source register (that is, the result of a single-precision load floating-point from WORD will not compare equal to the contents of the original source register).

Note that the description of conversion steps presented here is only a model. The actual implementation may vary from this description but must produce results equivalent to what this model would produce.

It is important to note that for double-precision store floating-point instructions and for the store floating-point as integer word instruction no conversion is required as the data from the FPR is copied directly into memory.

Appendix E

Synchronization Programming Examples

The examples in this appendix show how synchronization instructions can be used to emulate various synchronization primitives and how to provide more complex forms of synchronization.

For each of these examples, it is assumed that a similar sequence of instructions is used by all processes requiring synchronization of the accessed data.

E.1 General Information

The following points provide general information about the **lwarx** and **stwcx** instructions:

- In general, **lwarx** and **stwcx** instructions should be paired, with the same effective address (EA) used for both. The only exception is that an unpaired **stwcx** instruction to any (scratch) effective address can be used to clear any reservation held by the processor.
- It is acceptable to execute an **lwarx** instruction for which no **stwcx** instruction is executed. Such a dangling **lwarx** instruction occurs in the example shown in Section E.2.5, “Test and Set,” if the value loaded is not zero.
- To increase the likelihood that forward progress is made, it is important that looping on **lwarx/stwcx** pairs be minimized. For example, in the sequence shown in Section E.2.5, “Test and Set,” this is achieved by testing the old value before attempting the store—were the order reversed, more **stwcx** instructions might be executed, and reservations might more often be lost between the **lwarx** and the **stwcx** instructions.
- The manner in which **lwarx** and **stwcx** are communicated to other processors and mechanisms, and between levels of the memory subsystem within a given processor, is implementation-dependent. In some implementations, performance may be improved by minimizing looping on an **lwarx** instruction that fails to return a desired value. For example, in the example provided in Section E.2.5, “Test and Set,” if the program stays in the loop until the word loaded is zero, the programmer can change the “**bne- \$+12**” to “**bne- loop**.”

In some implementations, better performance may be obtained by using an ordinary load instruction to do the initial checking of the value, as follows:

```
loop:  lwz      r5,0(r3) #load the word
       cmpwi   r5,0    #loop back if word
       bne-   loop    #not equal to 0
       lwarx  r5,0,r3  #try again, reserving
       cmpwi  r5,0    #(likely to succeed)
       bne   loop    #try to store nonzero
       stwcx. r4,0,r3  #
       bne-  loop    #loop if lost reservation
```

- In a multiprocessor, livelock (a state in which processors interact in a way such that no processor makes progress) is possible if a loop containing an **lwarx/stwcx.** pair also contains an ordinary store instruction for which any byte of the affected memory area is in the reservation granule of the reservation. For example, the first code sequence shown in Section E.5, “List Insertion,” can cause livelock if two list elements have next element pointers in the same reservation granule.

Note that the examples in this appendix use the **lwarx/stwcx.** instructions, which address words in memory. For 64-bit implementations, these examples can be modified to address double words by changing all **lwarx** instructions to **ldarx** instructions, all **stwcx.** instructions to **stdcx.** instructions, all **stw** instructions to **std** instructions, and all **cmpw** and **cmpwi** extended mnemonics to **cmpd** and **cmpdi**, respectively.

E.2 Synchronization Primitives

The following examples show how the **lwarx** and **stwcx.** instructions can be used to emulate various synchronization primitives. The sequences used to emulate the various primitives consist primarily of a loop using the **lwarx** and **stwcx.** instructions. Additional synchronization is unnecessary, because the **stwcx.** will fail, clearing the EQ bit, if the word loaded by **lwarx** has changed before the **stwcx.** is executed.

E.2.1 Fetch and No-Op

The fetch and no-op primitive atomically loads the current value in a word in memory. In this example, it is assumed that the address of the word to be loaded is in GPR3 and the data loaded are returned in GPR4.

```
loop:  lwarx   r4,0,r3 #load and reserve
       stwcx.  r4,0,r3 #store old value if still reserved
       bne-   loop    #loop if lost reservation
```

The **stwcx.**, if it succeeds, stores to the destination location the same value that was loaded by the preceding **lwarx**. While the store is redundant with respect to the value in the location, its success ensures that the value loaded by the **lwarx** was the current value (that is, the source of the value loaded by the **lwarx** was the last store to the location that preceded the **stwcx.** in the coherence order for the location).

E.2.2 Fetch and Store

The fetch and store primitive atomically loads and replaces a word in memory.

In this example, it is assumed that the address of the word to be loaded and replaced is in GPR3, the new value is in GPR4, and the old value is returned in GPR5.

```
loop:  lwarx   r5,0,r3 #load and reserve
       stwcx. r4,0,r3 #store new value if still reserved
       bne-   loop   #loop if lost reservation
```

E.2.3 Fetch and Add

The fetch and add primitive atomically increments a word in memory.

In this example, it is assumed that the address of the word to be incremented is in GPR3, the increment is in GPR4, and the old value is returned in GPR5.

```
loop:  lwarx   r5,0,r3      #load and reserve
       add    r0,r4,r5      #increment word
       stwcx. r0,0,r3      #store new value if still reserved
       bne-   loop         #loop if lost reservation
```

E.2.4 Fetch and AND

The fetch and AND primitive atomically ANDs a value into a word in memory.

In this example, it is assumed that the address of the word to be ANDed is in GPR3, the value to AND into it is in GPR4, and the old value is returned in GPR5.

```
loop:  lwarx   r5,0,r3      #load and reserve
       and    r0,r4,r5      #AND word
       stwcx. r0,0,r3      #store new value if still reserved
       bne-   loop         #loop if lost reservation
```

This sequence can be changed to perform another Boolean operation atomically on a word in memory, simply by changing the AND instruction to the desired Boolean instruction (OR, XOR, etc.).

E.2.5 Test and Set

This version of the test and set primitive atomically loads a word from memory, ensures that the word in memory is a nonzero value, and sets CR0[EQ] according to whether the value loaded is zero.

In this example, it is assumed that the address of the word to be tested is in GPR3, the new value (nonzero) is in GPR4, and the old value is returned in GPR5.

```
loop:  lwarx   r5,0,r3 #load and reserve
       cmpwi  r5, 0   #done if word
       bne   $+12   #not equal to 0
       stwcx. r4,0,r3 #try to store non-zero
       bne-   loop   #loop if lost reservation
```

E.3 Compare and Swap

The compare and swap primitive atomically compares a value in a register with a word in memory. If they are equal, it stores the value from a second register into the word in memory. If they are unequal, it loads the word from memory into the first register, and sets the EQ bit of the CR0 field to indicate the result of the comparison.

In this example, it is assumed that the address of the word to be tested is in GPR3, the word that is compared is in GPR4, the new value is in GPR5, and the old value is returned in GPR4.

```
loop:  lwarx   r6,0,r3 #load and reserve
       cmpw   r4,r6  #first 2 operands equal ?
       bne-   exit   #skip if not
       stwcx. r5,0,r3 #store new value if still reserved
       bne-   loop   #loop if lost reservation
exit:  mr     r4,r6  #return value from memory
```

Notes:

1. The semantics in this example are based on the IBM System/370™ compare and swap instruction. Other architectures may define this instruction differently.
2. Compare and swap is shown primarily for pedagogical reasons. It is useful on machines that lack the better synchronization facilities provided by the **lwarx** and **stwcx.** instructions. Although the instruction is atomic, it checks only for whether the current value matches the old value. An error can occur if the value had been changed and restored before being tested.
3. In some applications, the second **bne-** instruction and/or the **mr** instruction can be omitted. The first **bne-** is needed only if the application requires that if the EQ bit of CR0 field on exit indicates not equal, then the original compared value in **r4** and **r6** are in fact not equal. The **mr** is needed only if the application requires that if the compared values are not equal, then the word from memory is loaded into the register with which it was compared (rather than into a third register). If either, or both, of these instructions is omitted, the resulting compare and swap does not obey the IBM System/370 semantics.

E.4 Lock Acquisition and Release

This example provides an algorithm for locking that demonstrates the use of synchronization with an atomic read/modify/write operation. GPR3 provides a shared memory location, the address of which is an argument of the lock and unlock procedures. This argument is used as a lock to control access to some shared resource such as a data structure. The lock is open when its value is zero and locked when it is one. Before accessing the shared resource, a processor sets the lock by having the lock procedure call TEST_AND_SET, which executes the code sequence in Section E.2.5, “Test and Set.” This atomically sets the old value of the lock, and writes the new value (1) given to it in GPR4, returning the old value in GPR5 (not used in the following example) and setting the EQ bit in CR0 according to whether the value loaded is zero. The lock procedure repeats the test and set procedure until it successfully changes the value in the lock from zero to one.

The processor must not access the shared resource until it sets the lock. After the **bne** instruction that checks for the successful test and set operation, the processor executes the **isync** instruction. This delays all subsequent instructions until all previous instructions have completed to the extent required by context synchronization. The **sync** instruction could be used but performance would be degraded because the **sync** instruction waits for all outstanding memory accesses to complete with respect to other processors. This is not necessary here.

```
lock:  li      r4,1          #obtain lock
loop:  bl      test_and_set  #test and set
      bne-   loop          #retry until old = 0
      isync                    #delay subsequent instructions until
      blr                                #previous ones complete

      isync
      blr                                #return
```

The unlock procedure writes a zero to the lock location. If the access to the shared resource includes write operations, most applications that use locking require the processor to execute a **sync** instruction to make its modification visible to all processors before releasing the lock. For this reason, the unlock procedure in the following example begins with a **sync**.

```
unlock: sync                    #delay until prior stores finish
      li      r1,0
      stw    r1,0(r3)         #store zero to lock location
      blr                                #return
```

E.5 List Insertion

The following example shows how the **lwarx** and **stwcx.** instructions can be used to implement simple LIFO (last-in-first-out) insertion into a singly-linked list. (Complicated list insertion, in which multiple values must be changed atomically, or in which the correct order of insertion depends on the contents of the elements, cannot be implemented in the manner shown below, and requires a more complicated strategy such as using locks.)

The next element pointer from the list element after which the new element is to be inserted, here called the parent element, is stored into the new element, so that the new element points to the next element in the list—this store is performed unconditionally. Then the address of the new element is conditionally stored into the parent element, thereby adding the new element to the list.

In this example, it is assumed that the address of the parent element is in GPR3, the address of the new element is in GPR4, and the next element pointer is at offset zero from the start of the element. It is also assumed that the next element pointer of each list element is in a reservation granule separate from that of the next element pointer of all other list elements.

```
loop:  lwarx   r2,0,r3 #get next pointer
       stw    r2,0(r4)#store in new element
       sync   #let store settle (can omit if not MP)
       stwcx. r4,0,r3 #add new element to list
       bne-   loop  #loop if stwcx. failed
```

In the preceding example, if two list elements have next element pointers in the same reservation granule in a multiprocessor system, livelock can occur.

If it is not possible to allocate list elements such that each element's next element pointer is in a different reservation granule, livelock can be avoided by using the following sequence:

```
loop1:  lwz     r2,0(r3)#get next pointer
       mr     r5,r2 #keep a copy
       stw    r2,0(r4)#store in new element
       sync   #let store settle
loop2:  lwarx   r2,0,r3 #get it again
       cmpw   r2,r5 #loop if changed (someone
       bne-   loop1 #else progressed)
       stwcx. r4,0,r3 #add new element to list
       bne-   loop2 #loop if failed
```

Appendix F

Simplified Mnemonics

This appendix is provided in order to simplify the writing and comprehension of assembler language programs. Included are a set of simplified mnemonics and symbols that define the simple shorthand used for the most frequently-used forms of branch conditional, compare, trap, rotate and shift, and certain other instructions. (Note that the architecture specification refers to simplified mnemonics as extended mnemonics.)

F.1 Symbols

The symbols in Table F-1 are defined for use in instructions (basic or simplified mnemonics) that specify a condition register (CR) field or a bit in the CR.

Table F-1. Condition Register Bit and Identification Symbol Descriptions

Symbol	Value	Bit Field Range	Description
lt	0	—	Less than. Identifies a bit number within a CR field.
gt	1	—	Greater than. Identifies a bit number within a CR field.
eq	2	—	Equal. Identifies a bit number within a CR field.
so	3	—	Summary overflow. Identifies a bit number within a CR field.
un	3	—	Unordered (after floating-point comparison). Identifies a bit number in a CR field.
cr0	0	0–3	CR0 field
cr1	1	4–7	CR1 field
cr2	2	8–11	CR2 field
cr3	3	12–15	CR3 field
cr4	4	16–19	CR4 field
cr5	5	20–23	CR5 field
cr6	6	24–27	CR6 field
cr7	7	28–31	CR7 field

Note: To identify a CR bit, an expression in which a CR field symbol is multiplied by 4 and then added to a bit-number-within-CR-field symbol can be used.

Note that the simplified mnemonics in Section F.5.2, “Basic Branch Mnemonics,” and Section F.6, “Simplified Mnemonics for Condition Register Logical Instructions,” require identification of a CR bit—if one of the CR field symbols is used, it must be multiplied by 4 and added to a bit-number-within-CR-field (value in the range of 0–3, explicit or symbolic). The simplified mnemonics in Section F.5.3, “Branch Mnemonics Incorporating Conditions,” and Section F.3, “Simplified Mnemonics for Compare Instructions,” require identification of a CR field—if one of the CR field symbols is used, it must not be multiplied by 4. (For the simplified mnemonics in Section F.5.3, “Branch Mnemonics Incorporating Conditions,” the bit number within the CR field is part of the simplified mnemonic. The CR field is identified, and the assembler does the multiplication and addition required to produce a CR bit number for the BI field of the underlying basic mnemonic.)

F.2 Simplified Mnemonics for Subtract Instructions

This section discusses simplified mnemonics for the subtract instructions.

F.2.1 Subtract Immediate

Although there is no subtract immediate instruction, its effect can be achieved by using an add immediate instruction with the immediate operand negated. Simplified mnemonics are provided that include this negation, making the intent of the computation more clear.

subi rD,rA,value	(equivalent to	addi rD,rA,-value)
subis rD,rA,value	(equivalent to	addis rD,rA,-value)
subic rD,rA,value	(equivalent to	addic rD,rA,-value)
subic. rD,rA,value	(equivalent to	addic. rD,rA,-value)

F.2.2 Subtract

The subtract from instructions subtract the second operand (**rA**) from the third (**rB**). Simplified mnemonics are provided that use the more normal order in which the third operand is subtracted from the second. Both these mnemonics can be coded with an **o** suffix and/or dot (.) suffix to cause the OE and/or R_c bit to be set in the underlying instruction.

sub rD,rA,rB	(equivalent to	subf rD,rB,rA)
subc rD,rA,rB	(equivalent to	subfc rD,rB,rA)

F.3 Simplified Mnemonics for Compare Instructions

The L field in the integer compare instructions controls whether the operands are treated as 64-bit quantities (when L = 1) or as 32-bit quantities (when L = 0). Simplified mnemonics are provided that represent the L value in the mnemonic rather than requiring it to be coded as a numeric operand.

The **crfD** field can be omitted if the result of the comparison is to be placed into the CR0 field. Otherwise, the target CR field must be specified as the first operand. One of the CR field symbols defined in Section F.1, “Symbols,” can be used for this operand.

Note that the basic compare mnemonics of PowerPC are the same as those of POWER, but the POWER instructions have three operands while the PowerPC instructions have four. The assembler recognizes a basic compare mnemonic with the three operands as the POWER form, and generates the instruction with L = 0. Although the **crfD** field can normally be omitted when the CR0 field is the target, if L is specified the assembler requires that **crfD** be specified explicitly.

F.3.1 Double-Word Comparisons

The instructions listed in Table F-2 are simplified mnemonics that should be supported by assemblers provided for 64-bit implementations.

Table F-2. Simplified Mnemonics for Double-Word Compare Instructions

Operation	Simplified Mnemonic	Equivalent to:
Compare Double Word Immediate	cmpdi crfD,rA,SIMM	cmpi crfD,1,rA,SIMM
Compare Double Word	cmpd crfD,rA,rB	cmp crfD,1,rA,rB
Compare Logical Double Word Immediate	cmpldi crfD,rA,UIMM	cmpli crfD,1,rA,UIMM
Compare Logical Double Word	cmpld crfD,rA,rB	cmpl crfD,1,rA,rB

Following are examples using the double-word compare mnemonics.

1. Compare **rA** and immediate value 100 as unsigned 64-bit integers and place result in CR0.
cmpldi rA,100 (equivalent to **cmpli 0,1,rA,100**)
2. Same as (1), but place result in CR4.
cmpldi cr4,rA,100 (equivalent to **cmpli 4,1,rA,100**)
3. Compare **rA** and **rB** as signed 64-bit integers and place result in CR0.
cmpd rA,rB (equivalent to **cmpl 0,1,rA,rB**)

F.3.2 Word Comparisons

The instructions listed in Table F-3 are simplified mnemonics that should be supported by assemblers for all PowerPC implementations.

Table F-3. Simplified Mnemonics for Word Compare Instructions

Operation	Simplified Mnemonic	Equivalent to:
Compare Word Immediate	cmpwi crfD,rA,SIMM	cmpi crfD,0,rA,SIMM
Compare Word	cmpw crfD,rA,rB	cmp crfD,0,rA,rB
Compare Logical Word Immediate	cmplwi crfD,rA,UIMM	cmpli crfD,0,rA,UIMM
Compare Logical Word	cmplw crfD,rA,rB	cmpl crfD,0,rA,rB

Following are examples using the word compare mnemonics.

1. Compare **rA[32–63]** with immediate value 100 as signed 32-bit integers and place result in CR0.
cmpwi rA,100 (equivalent to **cmpi 0,0,rA,100**)
2. Same as (1), but place results in CR4.
cmpwi cr4,rA,100 (equivalent to **cmpi 4,0,rA,100**)
3. Compare **rA[32–63]** and **rB[32–63]** as unsigned 32-bit integers and place result in CR0.
cmplw rA,rB (equivalent to **cmpl 0,0,rA,rB**)

F.4 Simplified Mnemonics for Rotate and Shift Instructions

The rotate and shift instructions provide powerful and general ways to manipulate register contents, but can be difficult to understand. Simplified mnemonics that allow some of the simpler operations to be coded easily are provided for the following types of operations:

- Extract—Select a field of n bits starting at bit position b in the source register; left or right justify this field in the target register; clear all other bits of the target register.
- Insert—Select a left-justified or right-justified field of n bits in the source register; insert this field starting at bit position b of the target register; leave other bits of the target register unchanged. (No simplified mnemonic is provided for insertion of a left-justified field, when operating on double words, because such an insertion requires more than one instruction.)
- Rotate—Rotate the contents of a register right or left n bits without masking.
- Shift—Shift the contents of a register right or left n bits, clearing vacated bits (logical shift).
- Clear—Clear the leftmost or rightmost n bits of a register.
- Clear left and shift left—Clear the leftmost b bits of a register, then shift the register left by n bits. This operation can be used to scale a (known non-negative) array index by the width of an element.

F.4.1 Operations on Double Words

The operations shown in Table F-4 are available only in 64-bit implementations. All these mnemonics can be coded with a dot (.) suffix to cause the Rc bit to be set in the underlying instruction.

Table F-4. Double-Word Rotate and Shift Instructions

Operation	Simplified Mnemonic	Equivalent to:
Extract and left justify immediate	extldi <i>rA,rS,n,b</i> ($n > 0$)	rldicr <i>rA,rS,b,n-1</i>
Extract and right justify immediate	extrdi <i>rA,rS,n,b</i> ($n > 0$)	rldicl <i>rA,rS,b+n,64-n</i>
Insert from right immediate	insrdi <i>rA,rS,n,b</i> ($n > 0$)	rldimi <i>rA,rS,64-(b+n),b</i>
Rotate left immediate	rotldi <i>rA,rS,n</i>	rldicl <i>rA,rS,n,0</i>
Rotate right immediate	rotrdi <i>rA,rS,n</i>	rldicl <i>rA,rS,64-n,0</i>
Rotate left	rotld <i>rA,rS,rB</i>	rldcl <i>rA,rS,rB,0</i>
Shift left immediate	sldi <i>rA,rS,n</i> ($n < 64$)	rldicr <i>rA,rS,n,63-n</i>
Shift right immediate	srdi <i>rA,rS,n</i> ($n < 64$)	rldicl <i>rA,rS,64-n,n</i>
Clear left immediate	clrldi <i>rA,rS,n</i> ($n < 64$)	rldicl <i>rA,rS,0,n</i>
Clear right immediate	clrrdi <i>rA,rS,n</i> ($n < 64$)	rldicr <i>rA,rS,0,63-n</i>
Clear left and shift left immediate	clrldsdi <i>rA,rS,b,n</i> ($n \leq b \leq 63$)	rldic <i>rA,rS,n,b-n</i>

Examples using double-word mnemonics follow:

1. Extract the sign bit (bit 0) of **rS** and place the result right-justified into **rA**.
extrdi rA,rS,1,0 (equivalent to **rldicl rA,rS,1,63**)
2. Insert the bit extracted in (1) into the sign bit (bit 0) of **rB**.
insrdi rB,rA,1,0 (equivalent to **rldimi rB,rA,63,0**)
3. Shift the contents of **rA** left 8 bits.
sldi rA,rA,8 (equivalent to **rldicr rA,rA,8,55**)
4. Clear the high-order 32 bits of **rS** and place the result into **rA**.
clrldi rA,rS,32 (equivalent to **rldicl rA,rS,0,32**)

F.4.2 Operations on Words

The operations shown in Table F-5 are available in all implementations. All these mnemonics can be coded with a dot (.) suffix to cause the Rc bit to be set in the underlying instruction. The operations, as described in Section F.4.1, “Operations on Double Words,” apply only to the low-order 32 bits of the registers. The insert operations either preserve the high-order 32 bits of the target register or place rotated data there; the other operations clear these bits.

Table F-5. Word Rotate and Shift Instructions

Operation	Simplified Mnemonic	Equivalent to:
Extract and left justify immediate	extlwi rA, rS, n, b ($n > 0$)	rlwinm $rA, rS, b, 0, n - 1$
Extract and right justify immediate	extrwi rA, rS, n, b ($n > 0$)	rlwinm $rA, rS, b + n, 32 - n, 31$
Insert from left immediate	inslwi rA, rS, n, b ($n > 0$)	rlwimi $rA, rS, 32 - b, b, (b + n) - 1$
Insert from right immediate	insrwi rA, rS, n, b ($n > 0$)	rlwimi $rA, rS, 32 - (b + n), b, (b + n) - 1$
Rotate left immediate	rotlwi rA, rS, n	rlwinm $rA, rS, n, 0, 31$
Rotate right immediate	rotrwi rA, rS, n	rlwinm $rA, rS, 32 - n, 0, 31$
Rotate left	rotlw rA, rS, rB	rlwnm $rA, rS, rB, 0, 31$
Shift left immediate	slwi rA, rS, n ($n < 32$)	rlwinm $rA, rS, n, 0, 31 - n$
Shift right immediate	srwi rA, rS, n ($n < 32$)	rlwinm $rA, rS, 32 - n, n, 31$
Clear left immediate	clrlwi rA, rS, n ($n < 32$)	rlwinm $rA, rS, 0, n, 31$
Clear right immediate	clrrwi rA, rS, n ($n < 32$)	rlwinm $rA, rS, 0, 0, 31 - n$
Clear left and shift left immediate	clrlslwi rA, rS, b, n ($n \leq b \leq 31$)	rlwinm $rA, rS, n, b - n, 31 - n$

Examples using word mnemonics follow:

1. Extract the sign bit (bit 32) of **rS** and place the result right-justified into **rA**.
extrwi rA,rS,1,0 (equivalent to **rlwinm rA,rS,1,31,31**)
2. Insert the bit extracted in (1) into the sign bit (bit 32) of **rB**.
insrwi rB,rA,1,0 (equivalent to **rlwimi rB,rA,31,0,0**)
3. Shift the contents of **rA** left 8 bits, clearing the high-order 32 bits.
slwi rA,rA,8 (equivalent to **rlwinm rA,rA,8,0,23**)
4. Clear the high-order 16 bits of the low-order 32 bits of **rS** and place the result into **rA**, clearing the high-order 32 bits of **rA**.
clrlwi rA,rS,16 (equivalent to **rlwinm rA,rS,0,16,31**)

F.5 Simplified Mnemonics for Branch Instructions

Mnemonics are provided so that branch conditional instructions can be coded with the condition as part of the instruction mnemonic rather than as a numeric operand. Some of these are shown as examples with the branch instructions.

The mnemonics discussed in this section are variations of the branch conditional instructions.

F.5.1 BO and BI Fields

The 5-bit BO field in branch conditional instructions encodes the following operations.

- Decrement count register (CTR)
- Test CTR equal to zero
- Test CTR not equal to zero
- Test condition true
- Test condition false
- Branch prediction (taken, fall through)

The 5-bit BI field in branch conditional instructions specifies which of the 32 bits in the CR represents the condition to test.

To provide a simplified mnemonic for every possible combination of BO and BI fields would require $2^{10} = 1024$ mnemonics and most of these would be only marginally useful. The abbreviated set found in Section F.5.2, “Basic Branch Mnemonics,” is intended to cover the most useful cases. Unusual cases can be coded using a basic branch conditional mnemonic (**bc**, **bclr**, **bcctr**) with the condition to be tested specified as a numeric operand.

F.5.2 Basic Branch Mnemonics

The mnemonics in Table F-6 allow all the common BO operand encodings to be specified as part of the mnemonic, along with the absolute address (AA), and set link register (LR) bits.

Notice that there are no simplified mnemonics for relative and absolute unconditional branches. For these, the basic mnemonics **b**, **ba**, **bl**, and **bla** are used.

Table F-6 provides the abbreviated set of simplified mnemonics for the most commonly performed conditional branches.

Table F-6. Simplified Branch Mnemonics

Branch Semantics	LR Update Not Enabled				LR Update Enabled			
	bc Relative	bca Absolute	bclr to LR	bcctr to CTR	bcl Relative	bcla Absolute	bclrl to LR	bcctrl to CTR
Branch unconditionally	—	—	blr	bctr	—	—	blr	bctrl
Branch if condition true	bt	bta	btlr	btctr	btl	bta	btlr	btctrl
Branch if condition false	bf	bfa	bflr	bfctr	bfl	bfa	bflr	bfctrl
Decrement CTR, branch if CTR non-zero	bdnz	bdnza	bdnzlr	—	bdnzl	bdnzla	bdnzlr	—
Decrement CTR, branch if CTR non-zero AND condition true	bdnzt	bdnzta	bdnztlr	—	bdnztl	bdnzta	bdnztlr	—
Decrement CTR, branch if CTR non-zero AND condition false	bdnzf	bdnzfa	bdnzflr	—	bdnzfl	bdnzfa	bdnzflr	—
Decrement CTR, branch if CTR zero	bdz	bdza	bdzlr	—	bdzl	bdzla	bdzlr	—
Decrement CTR, branch if CTR zero AND condition true	bdzt	bdzta	bdztlr	—	bdztl	bdzta	bdztlr	—
Decrement CTR, branch if CTR zero AND condition false	bdzf	bdzfa	bdzflr	—	bdzfl	bdzfa	bdzflr	—

The simplified mnemonics shown in Table F-6 that test a condition require a corresponding CR bit as the first operand of the instruction. The symbols defined in Section F.1, “Symbols,” can be used in the operand in place of a numeric value.

The simplified mnemonics found in Table F-6 are used in the following examples:

- Decrement CTR and branch if it is still nonzero (closure of a loop controlled by a count loaded into CTR).
bdnz target (equivalent to **bc 16,0,target**)
- Same as (1) but branch only if CTR is non-zero and condition in CR0 is “equal.”
bdnzt eq,target (equivalent to **bc 8,2,target**)
- Same as (2), but “equal” condition is in CR5.
bdnzt 4 * cr5 + eq,target (equivalent to **bc 8,22,target**)
- Branch if bit 27 of CR is false.
bf 27,target (equivalent to **bc 4,27,target**)
- Same as (4), but set the link register. This is a form of conditional call.
bfl 27,target (equivalent to **bcl 4,27,target**)

Table F-7 provides the simplified mnemonics for the **bc** and **bca** instructions without link register updating, and the syntax associated with these instructions. Note that the default condition register specified by the simplified mnemonics in the table is CRO.

Table F-7. Simplified Branch Mnemonics for bc and bca Instructions without Link Register Update

Branch Semantics	LR Update Not Enabled			
	bc Relative	Simplified Mnemonic	bca Absolute	Simplified Mnemonic
Branch unconditionally	—	—	—	—
Branch if condition true	bc 12,0,target	bt 0,target	bca 12,0,target	bta 0,target
Branch if condition false	bc 4,0,target	bf 0,target	bca 4,0,target	bfa 0,target
Decrement CTR, branch if CTR nonzero	bc 16,0,target	bdnz target	bca 16,0,target	bdnza target
Decrement CTR, branch if CTR nonzero AND condition true	bc 8,0,target	bdnzt 0,target	bca 8,0,target	bdnzta 0,target
Decrement CTR, branch if CTR nonzero AND condition false	bc 0,0,target	bdnzf 0,target	bca 0,0,target	bdnzfa 0,target
Decrement CTR, branch if CTR zero	bc 18,0,target	bdz target	bca 18,0,target	bdza target
Decrement CTR, branch if CTR zero AND condition true	bc 10,0,target	bdzt 0,target	bca 10,0,target	bdzta 0,target
Decrement CTR, branch if CTR zero AND condition false	bc 2,0,target	bdzf 0,target	bca 2,0,target	bdzfa 0,target

Table F-8 provides the simplified mnemonics for the **bclr** and **bcclr** instructions without link register updating, and the syntax associated with these instructions. Note that the default condition register specified by the simplified mnemonics in the table is CR0.

Table F-8. Simplified Branch Mnemonics for bclr and bcclr Instructions without Link Register Update

Branch Semantics	LR Update Not Enabled			
	bclr to LR	Simplified Mnemonic	bcctr to CTR	Simplified Mnemonic
Branch unconditionally	bclr 20,0	blr	bcctr 20,0	bctr
Branch if condition true	bclr 12,0	btlr 0	bcctr 12,0	btctr 0
Branch if condition false	bclr 4,0	bfir 0	bcctr 4,0	bfctr 0
Decrement CTR, branch if CTR nonzero	bclr 16,0	bdnzlr	—	—
Decrement CTR, branch if CTR nonzero AND condition true	bclr 10,0	bdztlr 0	—	—
Decrement CTR, branch if CTR nonzero AND condition false	bclr 0,0	bdnzflr 0	—	—
Decrement CTR, branch if CTR zero	bclr 18,0	bdzlr	—	—
Decrement CTR, branch if CTR zero AND condition true	bclr 10,0	bdztlr 0	—	—
Decrement CTR, branch if CTR zero AND condition false	bcctr 0,0	bdzflr 0	—	—

Table F-9 provides the simplified mnemonics for the **bcl** and **bcla** instructions with link register updating, and the syntax associated with these instructions. Note that the default condition register specified by the simplified mnemonics in the table is CRO.

Table F-9. Simplified Branch Mnemonics for bcl and bcla Instructions with Link Register Update

Branch Semantics	LR Update Enabled			
	bcl Relative	Simplified Mnemonic	bcla Absolute	Simplified Mnemonic
Branch unconditionally	—	—	—	—
Branch if condition true	bcl 2,0,target	btl 0,target	bcla 12,0,target	btla 0,target
Branch if condition false	bcl 4,0,target	bfl 0,target	bcla 4,0,target	bfla 0,target
Decrement CTR, branch if CTR nonzero	bcl 16,0,target	bdnzl target	bcla 16,0,target	bdnzla target
Decrement CTR, branch if CTR nonzero AND condition true	bcl 8,0,target	bdnztl 0,target	bcla 8,0,target	bdnztla 0,target
Decrement CTR, branch if CTR nonzero AND condition false	bcl 0,0,target	bdnzfl 0,target	bcla 0,0,target	bdnzfla 0,target
Decrement CTR, branch if CTR zero	bcl 18,0,target	bdzl target	bcla 18,0,target	bdzla target
Decrement CTR, branch if CTR zero AND condition true	bcl 10,0,target	bdztl 0,target	bcla 10,0,target	bdztla 0,target
Decrement CTR, branch if CTR zero AND condition false	bcl 2,0,target	bdzfl 0,target	bcla 2,0,target	bdzfla 0,target

Table F-10 provides the simplified mnemonics for the **bclrl** and **bcctrl** instructions with link register updating, and the syntax associated with these instructions. Note that the default condition register specified by the simplified mnemonics in the table is CR0.

Table F-10. Simplified Branch Mnemonics for bclrl and bcctrl Instructions with Link Register Update

Branch Semantics	LR Update Enabled			
	bclrl to LR	Simplified Mnemonic	bcctrl to CTR	Simplified Mnemonic
Branch unconditionally	bclrl 20,0	blr	bcctrl 20,0	bctrl
Branch if condition true	bclrl 12,0	btlr 0	bcctrl 12,0	btctrl 0
Branch if condition false	bclrl 4,0	bfir 0	bcctrl 4,0	bfctrl 0
Decrement CTR, branch if CTR nonzero	bclrl 16,0	bdnzlr	—	—
Decrement CTR, branch if CTR nonzero AND condition true	bclrl 8,0	bdnztlr 0	—	—
Decrement CTR, branch if CTR nonzero AND condition false	bclrl 0,0	bdnzflr 0	—	—
Decrement CTR, branch if CTR zero	bclrl 18,0	bdzlr	—	—
Decrement CTR, branch if CTR zero AND condition true	bdztlr 0	bdztlr 0	—	—
Decrement CTR, branch if CTR zero AND condition false	bclrl 4,0	bfir 0	—	—

F.5.3 Branch Mnemonics Incorporating Conditions

The mnemonics defined in Table F-6 are variations of the branch if condition true and branch if condition false BO encodings, with the most useful values of BI represented in the mnemonic rather than specified as a numeric operand.

A standard set of codes (shown in Table F-11) has been adopted for the most common combinations of branch conditions.

Table F-11. Standard Coding for Branch Conditions

Code	Description
lt	Less than
le	Less than or equal
eq	Equal
ge	Greater than or equal
gt	Greater than
nl	Not less than
ne	Not equal
ng	Not greater than
so	Summary overflow
ns	Not summary overflow
un	Unordered (after floating-point comparison)
nu	Not unordered (after floating-point comparison)

Table F-12 shows the simplified branch mnemonics incorporating conditions.

Table F-12. Simplified Branch Mnemonics with Comparison Conditions

Branch Semantics	LR Update Not Enabled				LR Update Enabled			
	bc Relative	bca Absolute	bclr to LR	bcctr to CTR	bcl Relative	bcla Absolute	bclrl to LR	bcctrl to CTR
Branch if less than	blt	blta	bltlr	bltctr	bltl	bltla	bltlrl	bltctrl
Branch if less than or equal	ble	blea	blelr	blectr	blel	blela	blelrl	blectrl
Branch if equal	beq	beqa	beqlr	beqctr	beql	beqla	beqlrl	beqctrl
Branch if greater than or equal	bge	bgea	bgelr	bgectr	bgel	bgela	bgelrl	bgectrl
Branch if greater than	bgt	bgtla	bgtlr	bgtctr	bgtl	bgtla	bgtlrl	bgtctrl
Branch if not less than	bnl	bnla	bnlrl	bnlctr	bnll	bnlla	bnllrl	bnlctrl
Branch if not equal	bne	bnea	bnelr	bnectr	bnel	bnela	bnelrl	bnectrl
Branch if not greater than	bng	bnga	bnglr	bngctr	bngl	bngla	bnglrl	bngctrl
Branch if summary overflow	bsol	bsola	bsolr	bsolctr	bsol	bsola	bsolrl	bsolctrl
Branch if not summary overflow	bns	bnsa	bnsrl	bnsctr	bnsl	bnsla	bnsrlrl	bnsctrl
Branch if unordered	bun	buna	bunlr	bunctr	bunl	bunla	bunlrl	bunctrl
Branch if not unordered	bnu	bnua	bnulr	bnuctr	bnul	bnula	bnulrl	bnuctrl

Instructions using the mnemonics in Table F-12 specify the condition register field in an optional first operand. If the CR field being tested is CR0, this operand need not be specified. One of the CR field symbols defined in Section F.1, “Symbols,” can be used for this operand.

The simplified mnemonics found in Table F-12 are used in the following examples:

1. Branch if CR0 reflects condition “not equal.”
bne target (equivalent to **bc 4,2,target**)
2. Same as (1) but condition is in CR3.
bne cr3,target (equivalent to **bc 4,14,target**)
3. Branch to an absolute target if CR4 specifies “greater than,” setting the link register. This is a form of conditional “call.”
bgtla cr4,target (equivalent to **bcla 12,17,target**)
4. Same as (3), but target address is in the CTR.
bgtctrl cr4 (equivalent to **bcctrl 12,17**)

Table F-13 shows the simplified branch mnemonics for the **bc** and **bca** instructions without link register updating, and the syntax associated with these instructions. Note that the default condition register specified by the simplified mnemonics in the table is CR0.

Table F-13. Simplified Branch Mnemonics for bc and bca Instructions without Comparison Conditions and Link Register Updating

Branch Semantics	LR Update Not Enabled			
	bc Relative	Simplified Mnemonic	bca Absolute	Simplified Mnemonic
Branch if less than	bc 12,0,target	blt target	bca 12,0,target	blta target
Branch if less than or equal	bc 4,1,target	ble target	bca 4,1,target	blea target
Branch if equal	bc 12,2,target	beq target	bca 12,2,target	beqa target
Branch if greater than or equal	bc 4,0,target	bge target	bca 4,0,target	bgea target
Branch if greater than	bc 12,1,target	bgt target	bca 12,1,target	bgta target
Branch if not less than	bc 4,0,target	bnl target	bca 4,0,target	bnla target
Branch if not equal	bc 4,2,target	bne target	bca 4,2,target	bnea target
Branch if not greater than	bc 4,1,target	bng target	bca 4,1,target	bnga target
Branch if summary overflow	bc 12,3,target	bs0 target	bca 12,3,target	bs0a target
Branch if not summary overflow	bc 4,3,target	bns target	bca 4,3,target	bnsa target
Branch if unordered	bc 12,3,target	bun target	bca 12,3,target	buna target
Branch if not unordered	bc 4,3,target	bnu target	bca 4,3,target	bnu a target

Table F-14 shows the simplified branch mnemonics for the **bclr** and **bcctr** instructions without link register updating, and the syntax associated with these instructions. Note that the default condition register specified by the simplified mnemonics in the table is CR0.

Table F-14. Simplified Branch Mnemonics for bclr and bcctr Instructions without Comparison Conditions and Link Register Updating

Branch Semantics	LR Update Not Enabled			
	bclr to LR	Simplified Mnemonic	bcctr to CTR	Simplified Mnemonic
Branch if less than	bclr 12,0	bltlr	bcctr 12,0	bltctr
Branch if less than or equal	bclr 4,1	blelr	bcctr 4,1	blectr
Branch if equal	bclr 12,2	beqlr	bcctr 12,2	beqctr
Branch if greater than or equal	bclr 4,0	bgelr	bcctr 4,0	bgectr
Branch if greater than	bclr 12,1	bgtlr	bcctr 12,1	bgtctr
Branch if not less than	bclr 4,0	bnllr	bcctr 4,0	bnlctr
Branch if not equal	bclr 4,2	bnelr	bcctr 4,2	bnectr
Branch if not greater than	bclr 4,1	bnqlr	bcctr 4,1	bnqctr
Branch if summary overflow	bclr 12,3	bsolr	bcctr 12,3	bsoctr
Branch if not summary overflow	bclr 4,3	bnslr	bcctr 4,3	bnsctr
Branch if unordered	bclr 12,3	bunlr	bcctr 12,3	bunctr
Branch if not unordered	bclr 4,3	bnulr	bcctr 4,3	bnuctr

Table F-15 shows the simplified branch mnemonics for the **bcl** and **bcla** instructions with link register updating, and the syntax associated with these instructions. Note that the default condition register specified by the simplified mnemonics in the table is CR0.

Table F-15. Simplified Branch Mnemonics for bcl and bcla Instructions with Comparison Conditions and Link Register Update

Branch Semantics	LR Update Enabled			
	bcl Relative	Simplified Mnemonic	bcla Absolute	Simplified Mnemonic
Branch if less than	bcl 12,0,target	bltl target	bcla 12,0,target	bltla target
Branch if less than or equal	bcl 4,1,target	blel target	bcla 4,1,target	blela target
Branch if equal	beql target	beql target	bcla 12,2,target	beqla target
Branch if greater than or equal	bcl 4,0,target	bgel target	bcla 4,0,target	bgela target
Branch if greater than	bcl 12,1,target	bgtl target	bcla 12,1,target	bgtla target
Branch if not less than	bcl 4,0,target	bnll target	bcla 4,0,target	bnlla target
Branch if not equal	bcl 4,2,target	bnel target	bcla 4,2,target	bnela target
Branch if not greater than	bcl 4,1,target	bngl target	bcla 4,1,target	bn gla target
Branch if summary overflow	bcl 12,3,target	bsol target	bcla 12,3,target	bsola target
Branch if not summary overflow	bcl 4,3,target	bnsl target	bcla 4,3,target	bnsla target
Branch if unordered	bcl 12,3,target	bunl target	bcla 12,3,target	bunla target
Branch if not unordered	bcl 4,3,target	bnul target	bcla 4,3,target	bnula target

Table F-16 shows the simplified branch mnemonics for the **bclrl** and **bcctl** instructions with link register updating, and the syntax associated with these instructions. Note that the default condition register specified by the simplified mnemonics in the table is CR0.

Table F-16. Simplified Branch Mnemonics for bclrl and bcctl Instructions with Comparison Conditions and Link Register Update

Branch Semantics	LR Update Enabled			
	bclrl to LR	Simplified Mnemonic	bcctl to CTR	Simplified Mnemonic
Branch if less than	bclrl 12,0	blttrl 0	bcctl 12,0	bltctrl 0
Branch if less than or equal	bclrl 4,1	bletrl 0	bcctl 4,1	blectrl 0
Branch if equal	bclrl 12,2	beqtrl 0	bcctl 12,2	beqctrl 0
Branch if greater than or equal	bclrl 4,0	bgetrl 0	bcctl 4,0	bgectrl 0
Branch if greater than	bclrl 12,1	bgtrl 0	bcctl 12,1	bgctrl 0
Branch if not less than	bclrl 4,0	bnltrl 0	bcctl 4,0	bnlctrl 0
Branch if not equal	bclrl 4,2	bnetrl 0	bcctl 4,2	bnctrl 0
Branch if not greater than	bclrl 4,1	bngtrl 0	bcctl 4,1	bngctrl 0
Branch if summary overflow	bclrl 12,3	bsolrl 0	bcctl 12,3	bsoctrl 0
Branch if not summary overflow	bclrl 4,3	bnsrlrl 0	bcctl 4,3	bnsctrl 0
Branch if unordered	bclrl 12,3	buntrl 0	bcctl 12,3	bunctrl 0
Branch if not unordered	bclrl 4,3	bnulrl 0	bcctl 4,3	bnucctrl 0

F.5.4 Branch Prediction

In branch conditional instructions that are not always taken, the low-order bit (y bit) of the BO field provides a hint about whether the branch is likely to be taken. See Section 4.2.4.2, “Conditional Branch Control,” for more information on the y bit.

Assemblers should clear this bit unless otherwise directed. This default action indicates the following:

- A branch conditional with a negative displacement field is predicted to be taken.
- A branch conditional with a non-negative displacement field is predicted not to be taken (fall through).
- A branch conditional to an address in the LR or CTR is predicted not to be taken (fall through).

If the likely outcome (branch or fall through) of a given branch conditional instruction is known, a suffix can be added to the mnemonic that tells the assembler how to set the y bit. That is, ‘+’ indicates that the branch is to be taken and ‘-’ indicates that the branch is not to be taken. Such a suffix can be added to any branch conditional mnemonic, either basic or simplified.

For relative and absolute branches (**bc**[I][a]), the setting of the y bit depends on whether the displacement field is negative or non-negative. For negative displacement fields, coding the suffix ‘+’ causes the bit to be cleared, and coding the suffix ‘-’ causes the bit to be set. For non-negative displacement fields, coding the suffix ‘+’ causes the bit to be set, and coding the suffix ‘-’ causes the bit to be cleared.

For branches to an address in the LR or CTR (**bcclr**[I] or **bcctr**[I]), coding the suffix ‘+’ causes the y bit to be set, and coding the suffix ‘-’ causes the bit to be cleared.

Examples of branch prediction follow:

1. Branch if CR0 reflects condition “less than,” specifying that the branch should be predicted to be taken.
blt+ target
2. Same as (1), but target address is in the LR and the branch should be predicted not to be taken.
bltlr-

F.6 Simplified Mnemonics for Condition Register Logical Instructions

The condition register logical instructions, shown in Table F-17, can be used to set, clear, copy, or invert a given condition register bit. Simplified mnemonics are provided that allow these operations to be coded easily. Note that the symbols defined in Section F.1, “Symbols,” can be used to identify the condition register bit.

Table F-17. Condition Register Logical Mnemonics

Operation	Simplified Mnemonic	Equivalent to
Condition register set	crset bx	creqv bx,bx,bx
Condition register clear	crclr bx	crxor bx,bx,bx
Condition register move	crmove bx,by	cror bx,by,by
Condition register not	crnot bx,by	crnor bx,by,by

Examples using the condition register logical mnemonics follow:

1. Set CR bit 25.
crset 25 (equivalent to **creqv 25,25,25**)
2. Clear the SO bit of CR0.
crclr so (equivalent to **crxor 3,3,3**)
3. Same as (2), but SO bit to be cleared is in CR3.
crclr 4 * cr3 + so (equivalent to **crxor 15,15,15**)
4. Invert the EQ bit.
crnot eq,eq (equivalent to **crnor 2,2,2**)
5. Same as (4), but EQ bit to be inverted is in CR4, and the result is to be placed into the EQ bit of CR5.
crnot 4 * cr5 + eq, 4 * cr4 + eq (equivalent to **crnor 22,18,18**)

F.7 Simplified Mnemonics for Trap Instructions

A standard set of codes, shown in Table F-18, has been adopted for the most common combinations of trap conditions.

Table F-18. Standard Codes for Trap Instructions

Code	Description	TO Encoding	<	>	=	<U	>U
lt	Less than	16	1	0	0	0	0
le	Less than or equal	20	1	0	1	0	0
eq	Equal	4	0	0	1	0	0
ge	Greater than or equal	12	0	1	1	0	0
gt	Greater than	8	0	1	0	0	0
nl	Not less than	12	0	1	1	0	0
ne	Not equal	24	1	1	0	0	0
ng	Not greater than	20	1	0	1	0	0
llt	Logically less than	2	0	0	0	1	0
lle	Logically less than or equal	6	0	0	1	1	0
lge	Logically greater than or equal	5	0	0	1	0	1
lgt	Logically greater than	1	0	0	0	0	1
lnl	Logically not less than	5	0	0	1	0	1
lng	Logically not greater than	6	0	0	1	1	0
—	Unconditional	31	1	1	1	1	1

Note: The symbol "<U" indicates an unsigned less than evaluation will be performed. The symbol ">U" indicates an unsigned greater than evaluation will be performed.

The mnemonics defined in Table F-19 are variations of trap instructions, with the most useful values of TO represented in the mnemonic rather than specified as a numeric operand. Examples of the uses of trap mnemonics, shown in Table F-19, follow:

Table F-19. Trap Mnemonics

Trap Semantics	64-Bit Comparison		32-Bit Comparison	
	tdi Immediate	td Register	twi Immediate	tw Register
Trap unconditionally	—	—	—	trap
Trap if less than	tdlti	tdlt	twlti	twlt
Trap if less than or equal	tdlei	tdle	twlei	twle
Trap if equal	tdeqi	tdeq	tweqi	tweq
Trap if greater than or equal	tdgei	tdge	twgei	twge
Trap if greater than	tdgti	tdgt	twgti	twgt
Trap if not less than	tdnli	tdnl	twnli	twnl
Trap if not equal	tdnei	tdne	twnei	twne
Trap if not greater than	tdngi	tdng	twngi	twng
Trap if logically less than	tdllti	tdllt	twllti	twllt
Trap if logically less than or equal	tdllei	tdlle	twllei	twlle
Trap if logically greater than or equal	tdlgei	tdlge	twlgei	twlge
Trap if logically greater than	tdlgti	tdlgt	twlgti	twlgt
Trap if logically not less than	tdlnli	tdlnl	twlnli	twlnl
Trap if logically not greater than	tdlngi	tdlng	twlngi	twlng

1. Trap if 64-bit register **rA** is not zero.
tdnei rA,0 (equivalent to **tdi 24,rA,0**)
2. Trap if 64-bit register **rA** is not equal to **rB**.
tdne rA, rB (equivalent to **td 24,rA,rB**)
3. Trap if **rA**, considered as a 32-bit quantity, is logically greater than 0x7FF.
twlgti rA, 0x7FF (equivalent to **twi 1,rA, 0x7FF**)
4. Trap unconditionally.
trap (equivalent to **tw 31,0,0**)

Trap instructions evaluate a trap condition as follows:

- The contents of register **rA** are compared with either the sign-extended SIMM field or the contents of register **rB**, depending on the trap instruction.
- For **tdi** and **td**, the entire contents of **rA** (and **rB**) participate in the comparison; for **twi** and **tw**, only the contents of the low-order 32 bits of **rA** (and **rB**) participate in the comparison.

The comparison results in five conditions which are ANDed with operand TO. If the result is not 0, the trap exception handler is invoked. (Note that exceptions are referred to as interrupts in the architecture specification.) See Table F-20 for these conditions.

Table F-20. TO Operand Bit Encoding

TO Bit	ANDed with Condition
0	Less than, using signed comparison
1	Greater than, using signed comparison
2	Equal
3	Less than, using unsigned comparison
4	Greater than, using unsigned comparison

F.8 Simplified Mnemonics for Special-Purpose Registers

The **mtspr** and **mfspir** instructions specify a special-purpose register (SPR) as a numeric operand. Simplified mnemonics are provided that represent the SPR in the mnemonic rather than requiring it to be coded as a numeric operand. Table F-21 provides a list of the simplified mnemonics that should be provided by assemblers for SPR operations.

Table F-21. Simplified Mnemonics for SPRs

Special-Purpose Register	Move to SPR		Move from SPR	
	Simplified Mnemonic	Equivalent to	Simplified Mnemonic	Equivalent to
XER	mtxer rS	mtspr 1,rS	mfxr rD	mfspir rD,1
Link register	mtlr rS	mtspr 8,rS	mflr rD	mfspir rD,8
Count register	mtctr rS	mtspr 9,rS	mfctr rD	mfspir rD,9
DSISR	mtdsisr rS	mtspr 18,rS	mfdsisr rD	mfspir rD,18
Data address register	mtdar rS	mtspr 19,rS	mfdar rD	mfspir rD,19
Decrementer	mtdec rS	mtspr 22,rS	mfdec rD	mfspir rD,22
SDR1	mtsdr1 rS	mtspr 25,rS	mfedr1 rD	mfspir rD,25
Save and restore register 0	mtsrr0 rS	mtspr 26,rS	mfedr0 rD	mfspir rD,26
Save and restore register 1	mtsrr1 rS	mtspr 27,rS	mfedr1 rD	mfspir rD,27
SPRG0–SPRG3	mtspr n, rS	mtspr 272 + n,rS	mfspg rD, n	mfspir rD,272 + n
Address space register	mtasr rS	mtspr 280,rS	mfasr rD	mfspir rD,280
External access register	mtear rS	mtspr 282,rS	mfear rD	mfspir rD,282
Time base lower	mttbl rS	mtspr 284,rS	mftr rD	mfspir rD,268

Table F-21. Simplified Mnemonics for SPRs (Continued)

Special-Purpose Register	Move to SPR		Move from SPR	
	Simplified Mnemonic	Equivalent to	Simplified Mnemonic	Equivalent to
Time base upper	mttbu rS	mtspr 285 ,rS	mftbu rD	mftb rD,269
Processor version register	—	—	mfpvr rD	mfspir rD,287
IBAT register, upper	mtibatu n, rS	mtspr 528 + (2 * n) ,rS	mfibatu rD, n	mfspir rD,528 + (2 * n)
IBAT register, lower	mtibatl n, rS	mtspr 529 + (2 * n) ,rS	mfibatl rD, n	mfspir rD,529 + (2 * n)
DBAT register, upper	mtdbatu n, rS	mtspr 536 + (2 * n) ,rS	mfdbatu rD, n	mfspir rD,536 + (2 * n)
DBAT register, lower	mtdbatl n, rS	mtspr 537 + (2 * n) ,rS	mfdbatl rD, n	mfspir rD,537 + (2 * n)

Following are examples using the SPR simplified mnemonics found in Table F-21:

1. Copy the contents of the low-order 32 bits of rS to the XER.
mtxer rS (equivalent to **mtspr 1**,rS)
2. Copy the contents of the LR to rS.
mflr rS (equivalent to **mfspir** rS,8)
3. Copy the contents of rS to the CTR.
mtctr rS (equivalent to **mtspr 9**,rS)

F.9 Recommended Simplified Mnemonics

This section describes some of the most commonly-used operations (such as no-op, load immediate, load address, move register, and complement register).

F.9.1 No-Op (nop)

Many PowerPC instructions can be coded in a way that, effectively, no operation is performed. An additional mnemonic is provided for the preferred form of no-op. If an implementation performs any type of run-time optimization related to no-ops, the preferred form is the no-op that triggers the following:

nop (equivalent to **ori 0,0,0**)

F.9.2 Load Immediate (li)

The **addi** and **addis** instructions can be used to load an immediate value into a register. Additional mnemonics are provided to convey the idea that no addition is being performed but that data is being moved from the immediate operand of the instruction to a register.

1. Load a 16-bit signed immediate value into rD.
li rD,value (equivalent to **addi** rD,0,value)
2. Load a 16-bit signed immediate value, shifted left by 16 bits, into rD.
lis rD,value (equivalent to **addis** rD,0,value)

F.9.3 Load Address (la)

This mnemonic permits computing the value of a base-displacement operand, using the **addi** instruction which normally requires a separate register and immediate operands.

la rD,d(rA) (equivalent to **addi rD,rA,d**)

The **la** mnemonic is useful for obtaining the address of a variable specified by name, allowing the assembler to supply the base register number and compute the displacement. If the variable *v* is located at offset *dV* bytes from the address in register **rV**, and the assembler has been told to use register **rV** as a base for references to the data structure containing *v*, the following line causes the address of *v* to be loaded into register **rD**:

la rD,v (equivalent to **addi rD,rV,dV**)

F.9.4 Move Register (mr)

Several PowerPC instructions can be coded to copy the contents of one register to another. A simplified mnemonic is provided that signifies that no computation is being performed, but merely that data is being moved from one register to another.

The following instruction copies the contents of **rS** into **rA**. This mnemonic can be coded with a dot (.) suffix to cause the Rc bit to be set in the underlying instruction.

mr rA,rS (equivalent to **or rA,rS,rS**)

F.9.5 Complement Register (not)

Several PowerPC instructions can be coded in a way that they complement the contents of one register and place the result into another register. A simplified mnemonic is provided that allows this operation to be coded easily.

The following instruction complements the contents of **rS** and places the result into **rA**. This mnemonic can be coded with a dot (.) suffix to cause the Rc bit to be set in the underlying instruction.

not rA,rS (equivalent to **nor rA,rS,rS**)

F.9.6 Move to Condition Register (mctr)

This mnemonic permits copying the contents of the low-order 32 bits of a GPR to the condition register, using the same syntax as the **mfcrr** instruction.

mctr rS (equivalent to **mfcrr 0xFF,rS**)

Glossary of Terms and Abbreviations

The glossary contains an alphabetical list of terms, phrases, and abbreviations used in this book. Some of the terms and definitions included in the glossary are reprinted from *IEEE Std. 754-1985, IEEE Standard for Binary Floating-Point Arithmetic*, copyright ©1985 by the Institute of Electrical and Electronics Engineers, Inc. with the permission of the IEEE.

Note that some terms are defined in the context of how they are used in this book.

A **Architecture.** A detailed specification of requirements for a processor or computer system. It does not specify details of how the processor or computer system must be implemented; instead it provides a template for a family of compatible *implementations*.

Asynchronous exception. *Exceptions* that are caused by events external to the processor's execution. In this document, the term 'asynchronous exception' is used interchangeably with the word *interrupt*.

Atomic access. A bus access that attempts to be part of a read-write operation to the same address uninterrupted by any other access to that address (the term refers to the fact that the transactions are indivisible). The PowerPC architecture implements atomic accesses through the **lwarx/stwex**. (**ldarx/stdex**. in 64-bit implementations) instruction pair.

B **BAT (block address translation) mechanism.** A software-controlled array that stores the available block address translations on-chip.

Biased exponent. An *exponent* whose range of values is shifted by a constant (bias). Typically a bias is provided to allow a range of positive values to express a range that includes both positive and negative values.

Big-endian. A byte-ordering method in memory where the address *n* of a word corresponds to the *most-significant byte*. In an addressed memory word, the bytes are ordered (left to right) 0, 1, 2, 3, with 0 being the most-significant byte. *See* Little-endian.

Block. An area of memory that ranges from 128 Kbyte to 256 Mbyte, whose size, translation, and protection attributes are controlled by the *BAT mechanism*.

Boundedly undefined. A characteristic of results of certain operations that are not rigidly prescribed by the PowerPC architecture. Boundedly-undefined results for a given operation may vary among implementations, and between execution attempts in the same implementation.

Although the architecture does not prescribe the exact behavior for when results are allowed to be boundedly undefined, the results of executing instructions in contexts where results are allowed to be boundedly undefined are constrained to ones that could have been achieved by executing an arbitrary sequence of defined instructions, in valid form, starting in the state the machine was in before attempting to execute the given instruction.

C

Cache. High-speed memory component containing recently-accessed data and/or instructions (subset of main memory).

Cache block. A small region of contiguous memory that is copied from memory into a *cache*. The size of a cache block may vary among processors; the maximum block size is one *page*. In PowerPC processors, *cache coherency* is maintained on a cache-block basis. Note that the term ‘cache block’ is often used interchangeably with ‘cache line’.

Cache coherency. An attribute wherein an accurate and common view of memory is provided to all devices that share the same memory system. Caches are coherent if a processor performing a read from its cache is supplied with data corresponding to the most recent value written to memory or to another processor’s cache.

Cache flush. An operation that removes from a cache any data from a specified address range. This operation ensures that any modified data within the specified address range is written back to main memory. This operation is generated typically by a Data Cache Block Flush (**dcbf**) instruction.

Caching-inhibited. A memory update policy in which the *cache* is bypassed and the load or store is performed to or from main memory.

Cast-outs. *Cache blocks* that must be written to memory when a cache miss causes a cache block to be replaced.

Changed bit. One of two *page history bits* found in each *page table entry* (PTE). The processor sets the changed bit if any store is performed into the *page*. *See also* Page access history bits and Referenced bit.

Clear. To cause a bit or bit field to register a value of zero. *See also* Set.

Context synchronization. An operation that ensures that all instructions in execution complete past the point where they can produce an *exception*, that all instructions in execution complete in the context in which they began execution, and that all subsequent instructions are *fetches* and executed in the new context. Context synchronization may result from executing specific instructions (such as **isync** or **rfi**) or when certain events occur (such as an exception).

Copy-back. An operation in which modified data in a *cache block* is copied back to memory.

D

Denormalized number. A nonzero floating-point number whose *exponent* has a reserved value, usually the format's minimum, and whose explicit or implicit leading significand bit is zero.

Direct-mapped cache. A cache in which each main memory address can appear in only one location within the cache, operates more quickly when the memory request is a cache hit.

Direct-store. Interface available on PowerPC processors only to support direct-store devices from the POWER architecture. When the T bit of a *segment descriptor* is set, the descriptor defines the region of memory that is to be used as a direct-store segment. Note that this facility is being phased out of the architecture and will not likely be supported in future devices. Therefore, software should not depend on it and new software should not use it.

E

Effective address (EA). The 32- or 64-bit address specified for a load, store, or an instruction fetch. This address is then submitted to the MMU for translation to either a *physical memory* address or an I/O address.

Exception. A condition encountered by the processor that requires special, supervisor-level processing.

Exception handler. A software routine that executes when an exception is taken. Normally, the exception handler corrects the condition that caused the exception, or performs some other meaningful task (that may include aborting the program that caused the exception). The address for each exception handler is identified by an exception

vector offset defined by the architecture and a prefix selected via the MSR.

Extended opcode. A secondary opcode field generally located in instruction bits 21–30, that further defines the instruction type. All PowerPC instructions are one word in length. The most significant 6 bits of the instruction are the *primary opcode*, identifying the type of instruction. *See also* Primary opcode.

Execution synchronization. A mechanism by which all instructions in execution are architecturally complete before beginning execution (appearing to begin execution) of the next instruction. Similar to context synchronization but doesn't force the contents of the instruction buffers to be deleted and refetched.

Exponent. In the binary representation of a floating-point number, the exponent is the component that normally signifies the integer power to which the value two is raised in determining the value of the represented number. *See also* Biased exponent.

F

Fetch. Retrieving instructions from either the cache or main memory and placing them into the instruction queue.

Floating-point register (FPR). Any of the 32 registers in the floating-point register file. These registers provide the source operands and destination results for floating-point instructions. Load instructions move data from memory to FPRs and store instructions move data from FPRs to memory. The FPRs are 64 bits wide and store floating-point values in double-precision format.

Fraction. In the binary representation of a floating-point number, the field of the *significand* that lies to the right of its implied binary point.

Fully-associative. Addressing scheme where every cache location (every byte) can have any possible address.

G

General-purpose register (GPR). Any of the 32 registers in the general-purpose register file. These registers provide the source operands and destination results for all integer data manipulation instructions. Integer load instructions move data from memory to GPRs and store instructions move data from GPRs to memory.

Guarded. The guarded attribute pertains to out-of-order execution. When a page is designated as guarded, instructions and data cannot be accessed out-of-order.

H **Harvard architecture.** An architectural model featuring separate caches for instruction and data.

Hashing. An algorithm used in the *page table* search process.

I **IEEE 754.** A standard written by the Institute of Electrical and Electronics Engineers that defines operations and representations of binary floating-point arithmetic.

Illegal instructions. A class of instructions that are not implemented for a particular PowerPC processor. These include instructions not defined by the PowerPC architecture. In addition, for 32-bit implementations, instructions that are defined only for 64-bit implementations are considered to be illegal instructions. For 64-bit implementations instructions that are defined only for 32-bit implementations are considered to be illegal instructions.

Implementation. A particular processor that conforms to the PowerPC architecture, but may differ from other architecture-compliant implementations for example in design, feature set, and implementation of *optional* features. The PowerPC architecture has many different implementations.

Implementation-dependent. An aspect of a feature in a processor's design that is defined by a processor's design specifications rather than by the PowerPC architecture.

Implementation-specific. An aspect of a feature in a processor's design that is not required by the PowerPC architecture, but for which the PowerPC architecture may provide concessions to ensure that processors that implement the feature do so consistently.

Imprecise exception. A type of *synchronous exception* that is allowed not to adhere to the precise exception model (*see* Precise exception). The PowerPC architecture allows only floating-point exceptions to be handled imprecisely.

Inexact. Loss of accuracy in an arithmetic operation when the rounded result differs from the infinitely precise value with unbounded range.

In-order. An aspect of an operation that adheres to a sequential model. An operation is said to be performed in-order if, at the time that it is performed, it is known to be required by the sequential execution model. *See* Out-of-order.

Instruction latency. The total number of clock cycles necessary to execute an instruction and make ready the results of that instruction.

Instruction parallelism. A feature of PowerPC processors that allows instructions to be processed in parallel.

Interrupt. An *asynchronous exception*. On PowerPC processors, interrupts are a special case of exceptions. *See also* asynchronous exception.

Invalid state. State of a cache entry that does not currently contain a valid copy of a cache block from memory.

K **Key bits.** A set of key bits referred to as Ks and Kp in each segment register and each BAT register. The key bits determine whether supervisor or user programs can access a *page* within that *segment* or *block*.

Kill. An operation that causes a *cache block* to be invalidated.

L **L2 cache.** *See* Secondary cache.

Least-significant bit (lsb). The bit of least value in an address, register, data element, or instruction encoding.

Least-significant byte (LSB). The byte of least value in an address, register, data element, or instruction encoding.

Little-endian. A byte-ordering method in memory where the address *n* of a word corresponds to the *least-significant byte*. In an addressed memory word, the bytes are ordered (left to right) 3, 2, 1, 0, with 3 being the *most-significant byte*. *See* Big-endian.

M **MESI (modified/exclusive/shared/invalid).** *Cache coherency* protocol used to manage caches on different devices that share a memory system. Note that the PowerPC architecture does not specify the implementation of a MESI protocol to ensure cache coherency.

Memory access ordering. The specific order in which the processor performs load and store memory accesses and the order in which those accesses complete.

Memory-mapped accesses. Accesses whose addresses use the page or block address translation mechanisms provided by the MMU and that occur externally with the bus protocol defined for memory.

Memory coherency. An aspect of caching in which it is ensured that an accurate view of memory is provided to all devices that share system memory.

Memory consistency. Refers to agreement of levels of memory with respect to a single processor and system memory (for example, on-chip cache, secondary cache, and system memory).

Memory management unit (MMU). The functional unit that is capable of translating an *effective* (logical) *address* to a physical address, providing protection mechanisms, and defining caching methods.

Microarchitecture. The hardware details of a microprocessor's design. Such details are not defined by the PowerPC architecture.

Mnemonic. The abbreviated name of an instruction used for coding.

Modified state. When a cache block is in the modified state, it has been modified by the processor since it was copied from memory. *See* MESI.

Munging. A modification performed on an *effective address* that allows it to appear to the processor that individual aligned scalars are stored as *little-endian* values, when in fact it is stored in *big-endian* order, but at different byte addresses within double words. Note that munging affects only the effective address and not the byte order. Note also that this term is not used by the PowerPC architecture.

Multiprocessing. The capability of software, especially operating systems, to support execution on more than one processor at the same time.

Most-significant bit (msb). The highest-order bit in an address, registers, data element, or instruction encoding.

Most-significant byte (MSB). The highest-order byte in an address, registers, data element, or instruction encoding.

N

NaN. An abbreviation for 'Not a Number'; a symbolic entity encoded in floating-point format. There are two types of NaNs—signaling NaNs (SNaNs) and quiet NaNs (QNaNs).

No-op. No-operation. A single-cycle operation that does not affect registers or generate bus activity.

Normalization. A process by which a floating-point value is manipulated such that it can be represented in the format for the appropriate precision (single- or double-precision). For a floating-point value to

be representable in the single- or double-precision format, the leading implied bit must be a 1.

-
- O**
- OEA (operating environment architecture).** The level of the architecture that describes PowerPC memory management model, supervisor-level registers, synchronization requirements, and the exception model. It also defines the time-base feature from a supervisor-level perspective. Implementations that conform to the PowerPC OEA also conform to the PowerPC UISA and VEA.
- Optional.** A feature, such as an instruction, a register, or an exception, that is defined by the PowerPC architecture but not required to be implemented.
- Out-of-order.** An aspect of an operation that allows it to be performed ahead of one that may have preceded it in the sequential model, for example, speculative operations. An operation is said to be performed out-of-order if, at the time that it is performed, it is not known to be required by the sequential execution model. *See* In-order.
- Out-of-order execution.** A technique that allows instructions to be issued and completed in an order that differs from their sequence in the instruction stream.
- Overflow.** An error condition that occurs during arithmetic operations when the result cannot be stored accurately in the destination register(s). For example, if two 32-bit numbers are multiplied, the result may not be representable in 32 bits.

-
- P**
- Page.** A region in memory. The OEA defines a page as a 4-Kbyte area of memory, aligned on a 4-Kbyte boundary.
- Page access history bits.** The *changed* and *referenced* bits in the PTE keep track of the access history within the page. The referenced bit is set by the MMU whenever the page is accessed for a read or write operation. The changed bit is set when the page is stored into. *See* Changed bit and Referenced bit.
- Page fault.** A page fault is a condition that occurs when the processor attempts to access a memory location that does not reside within a *page* not currently resident in *physical memory*. On PowerPC processors, a page fault exception condition occurs when a matching, valid *page table entry* ($PTE[V] = 1$) cannot be located.

Page table. A table in memory is comprised of *page table entries*, or PTEs. It is further organized into eight PTEs per PTEG (page table entry group). The number of PTEGs in the page table depends on the size of the page table (as specified in the SDR1 register).

Page table entry (PTE). Data structures containing information used to translate *effective address* to physical address on a 4-Kbyte page basis. A PTE consists of 8 bytes of information in a 32-bit processor and 16 bytes of information in a 64-bit processor.

Physical memory. The actual memory that can be accessed through the system's memory bus.

Pipelining. A technique that breaks operations, such as instruction processing or bus transactions, into smaller distinct stages or tenures (respectively) so that a subsequent operation can begin before the previous one has completed.

Precise exceptions. A category of exception for which the pipeline can be stopped so instructions that preceded the faulting instruction can complete, and subsequent instructions can be flushed and redispached after exception handling has completed. *See* Imprecise exceptions.

Primary opcode. The most-significant 6 bits (bits 0–5) of the instruction encoding that identifies the type of instruction. *See* Secondary opcode.

Protection boundary. A boundary between *protection domains*.

Protection domain. A protection domain is a segment, a virtual page, a BAT area, or a range of unmapped effective addresses. It is defined only when the appropriate relocate bit in the MSR (IR or DR) is 1.

Q

Quad word. A group of 16 contiguous locations starting at an address divisible by 16.

Quiet NaN. A type of *NaN* that can propagate through most arithmetic operations without signaling exceptions. A quiet NaN is used to represent the results of certain invalid operations, such as invalid arithmetic operations on infinities or on NaNs, when invalid. *See* Signaling NaN.

R

rA. The **rA** instruction field is used to specify a GPR to be used as a source or destination.

rB. The **rB** instruction field is used to specify a GPR to be used as a source.

rD. The **rD** instruction field is used to specify a GPR to be used as a destination.

rS. The **rS** instruction field is used to specify a GPR to be used as a source.

Real address mode. An MMU mode when no address translation is performed and the *effective address* specified is the same as the physical address. The processor's MMU is operating in real address mode if its ability to perform address translation has been disabled through the MSR registers IR and/or DR bits.

Record bit. Bit 31 (or the Rc bit) in the instruction encoding. When it is set, updates the condition register (CR) to reflect the result of the operation.

Referenced bit. One of two *page history bits* found in each *page table entry* (PTE). The processor sets the *referenced bit* whenever the page is accessed for a read or write. *See also* Page access history bits.

Register indirect addressing. A form of addressing that specifies one GPR that contains the address for the load or store.

Register indirect with immediate index addressing. A form of addressing that specifies an immediate value to be added to the contents of a specified GPR to form the target address for the load or store.

Register indirect with index addressing. A form of addressing that specifies that the contents of two GPRs be added together to yield the target address for the load or store.

Reservation. The processor establishes a reservation on a *cache block* of memory space when it executes an **lwarx** or **ldarx** instruction to read a memory semaphore into a GPR.

Reserved field. In a register, a reserved field is one that is not assigned a function. A reserved field may be a single bit. The handling of reserved bits is *implementation-dependent*. Software is permitted to write any value to such a bit. A subsequent reading of the bit returns 0 if the value last written to the bit was 0 and returns an undefined value (0 or 1) otherwise.

RISC (reduced instruction set computing). An *architecture* characterized by fixed-length instructions with nonoverlapping functionality and by a separate set of load and store instructions that perform memory accesses.

S

SLB (segment lookaside buffer). An optional cache that holds recently-used *segment table entries*.

Scalability. The capability of an architecture to generate *implementations* specific for a wide range of purposes, and in particular implementations of significantly greater performance and/or functionality than at present, while maintaining compatibility with current implementations.

Secondary cache. A cache memory that is typically larger and has a longer access time than the primary cache. A secondary cache may be shared by multiple devices. Also referred to as L2, or level-2, cache.

Segment. A 256-Mbyte area of *virtual memory* that is the most basic memory space defined by the PowerPC architecture. Each segment is configured through a unique *segment descriptor*.

Segment descriptors. Information used to generate the interim *virtual address*. The segment descriptors reside in 16 on-chip segment registers for 32-bit implementations. For 64-bit implementations, the segment descriptors reside as *segment table entries* in a hashed segment table in memory.

Segment table. A 4-Kbyte (1-page) data structure that defines the mapping between effective segments and virtual segments for a process. Segment tables are implemented on 64-bit processors only.

Segment table entry (STE). Data structures containing information used to translate *effective address* to physical address in a 64-bit implementation. STEs are implemented on 64-bit processors only.

Set (*v*). To write a nonzero value to a bit or bit field; the opposite of *clear*. The term ‘set’ may also be used to generally describe the updating of a bit or bit field.

Set (*n*). A subdivision of a *cache*. Cacheable data can be stored in a given location in any one of the sets, typically corresponding to its lower-order address bits. Because several memory locations can map to the same location, cached data is typically placed in the set whose *cache block* corresponding to that address was used least recently. *See* Set-associative.

Set-associative. Aspect of cache organization in which the cache space is divided into sections, called *sets*. The cache controller associates a particular main memory address with the contents of a particular set, or region, within the cache.

Signaling NaN. A type of *NaN* that generates an invalid operation program exception when it is specified as arithmetic operands. *See* Quiet NaN.

Significand. The component of a binary floating-point number that consists of an explicit or implicit leading bit to the left of its implied binary point and a fraction field to the right.

Simplified mnemonics. Assembler mnemonics that represent a more complex form of a common operation.

Static branch prediction. Mechanism by which software (for example, compilers) can give a hint to the machine hardware about the direction a branch is likely to take.

Sticky bit. A bit that when *set* must be cleared explicitly.

Strong ordering. A memory access model that requires exclusive access to an address before making an update, to prevent another device from using stale data.

Superscalar machine. A machine that can issue multiple instructions concurrently from a conventional linear instruction stream.

Supervisor mode. The privileged operation state of a processor. In supervisor mode, software, typically the operating system, can access all control registers and can access the supervisor memory space, among other privileged operations.

Synchronization. A process to ensure that operations occur strictly *in order*. *See* Context synchronization and Execution synchronization.

Synchronous exception. An *exception* that is generated by the execution of a particular instruction or instruction sequence. There are two types of synchronous exceptions, *precise* and *imprecise*.

System memory. The physical memory available to a processor.

T **TLB (translation lookaside buffer)** A cache that holds recently-used *page table entries*.

Throughput. The measure of the number of instructions that are processed per clock cycle.

Tiny. A floating-point value that is too small to be represented for a particular precision format, including *denormalized* numbers; they do not include ± 0 .

U **UISA (user instruction set architecture).** The level of the architecture to which user-level software should conform. The UISA defines the base user-level instruction set, user-level registers, data types, floating-point memory conventions and exception model as seen by user programs, and the memory and programming models.

Underflow. An error condition that occurs during arithmetic operations when the result cannot be represented accurately in the destination register. For example, underflow can happen if two floating-point fractions are multiplied and the result requires a smaller *exponent* and/or mantissa than the single-precision format can provide. In other words, the result is too small to be represented accurately.

Unified cache. Combined data and instruction cache.

User mode. The unprivileged operating state of a processor used typically by application software. In user mode, software can only access certain control registers and can access only user memory space. No privileged operations can be performed. Also referred to as problem state.

V **VEA (virtual environment architecture).** The level of the *architecture* that describes the memory model for an environment in which multiple devices can access memory, defines aspects of the cache model, defines cache control instructions, and defines the time-base facility from a user-level perspective. *Implementations* that conform to the PowerPC VEA also adhere to the UISA, but may not necessarily adhere to the OEA.

Virtual address. An intermediate address used in the translation of an *effective address* to a physical address.

Virtual memory. The address space created using the memory management facilities of the processor. Program access to virtual memory is possible only when it coincides with *physical memory*.

W

Weak ordering. A memory access model that allows bus operations to be reordered dynamically, which improves overall performance and in particular reduces the effect of memory latency on instruction throughput.

Word. A 32-bit data element.

Write-back. A cache memory update policy in which processor write cycles are directly written only to the cache. External memory is updated only indirectly, for example, when a modified cache block is *cast out* to make room for newer data.

Write-through. A cache memory update policy in which all processor write cycles are written to both the cache and memory.

INDEX

Numerics

64-bit bridge
 address translation types, 7-14
 ASR register, V bit, 2-31, 7-98, 7-103, 7-115
 description, 1-6, 1-9, 7-2
 features/related changes, 1-19
 instructions
 mfsr, 4-75, 7-118, 8-158
 mfsrin, 4-75, 7-119, 8-160
 mtmsr, 4-71, 7-116, 8-169
 mtr, 4-74, 8-175
 mtrsd, 4-74, 7-26, 7-123, 8-177
 mtrsdin, 4-74, 7-26, 7-123, 8-178
 mtrsin, 4-74, 7-121, 8-180
 optional instructions, 4-5
 rfi, 4-70, 6-20, 7-116, 8-195
 SR manipulation instructions, 7-117
 MMU features, 7-3
 MSR register, ISF bit, 2-21, 6-16, 7-116
 operating system migration, 7-115
 page address translation, 7-45
 segment table hashing, use of, 7-100
 segment table, 32-bit mode, 7-103
 SLBs (segment lookaside buffers), 7-2, 7-25
 SR manipulation instructions, 4-73

A

Accesses
 access order, 5-2
 atomic accesses (guaranteed), 5-4
 atomic accesses (not guaranteed), 5-4
 misaligned accesses, 3-1
Acronyms and abbreviated terms, list, xxxiv
add, 4-13, 8-10
addc, 4-13, 8-11
adde, 4-14, 8-12
addi, 4-12, 8-13, F-23
addic, 4-13, 8-14
addic., 4-13, 8-15
addis, 4-12, 8-16, F-23
addme, 4-14, 8-17
Address calculation
 branch instructions, 4-47
 load and store instructions, 4-34
Address mapping examples, PTEG, 7-81
Address translation, *see* Memory management unit
Addressing conventions

 alignment, 3-1
 byte ordering, 3-2, 3-6
 I/O data transfer, 3-11
 instruction memory addressing, 3-10
 mapping examples, 3-3
 memory operands, 3-2
Addressing modes
 branch conditional to absolute, 4-50
 branch conditional to count register, 4-51, B-4
 branch conditional to link register, 4-50
 branch conditional to relative, 4-48
 branch relative, 4-47
 branch to absolute, 4-49
 register indirect
 integer, 4-35
 with immediate index, floating-point, 4-43
 with immediate index, integer, 4-34
 with index, floating-point, 4-43
 with index, integer, 4-35
adde, 4-14, 8-18
Aligned data transfer, 1-12, 3-1
Aligned scalars, LE mode, 3-6
Alignment
 AL bit in MSR, POWER, B-2
 alignment exception
 description, 6-30
 integer alignment exception, 6-33
 interpreting the DSISR settings, 6-34
 LE mode alignment exception, 6-33
 MMU-related exception, 7-23
 overview, 6-4
 partially executed instructions, 6-11
 register settings, 6-31
 alignment for load/store multiple, B-5
 rules, 3-1, 3-6
and, 4-19, 8-19
andc, 4-20, 8-20
andi., 4-19, 8-21
andis., 4-19, 8-22
Arithmetic instructions
 floating-point, 4-26, A-20
 integer, 4-2, 4-12, A-17
ASR register
 description, 2-30, 7-97
 generation of STEG addresses, 7-103
 STABORG, 2-30
 V bit (64-bit bridge), 2-31, 7-98, 7-103, 7-115

INDEX

- Asynchronous exceptions
 - causes, 6-3
 - classifications, 6-3
 - decrementer exception, 6-5, 6-8, 6-38
 - external interrupt, 6-4, 6-8, 6-29
 - machine check exception, 6-4, 6-8, 6-24
 - system reset, 6-4, 6-8, 6-23
 - types, 6-8
- Atomic memory references
 - atomicity, 5-4
 - ldarx/stdcx., 4-59, 5-4, E-1
 - lwarx/stwcx., 4-59, 5-4, E-1
- B**
- b, 4-55, 8-23
- BAT registers, *see* Block address translation
- bc, 4-55, 8-24
- bcctr, 4-55, 8-26
- bclr, 4-55, 8-28
- Biased exponent format, 3-17
- Big-endian mode
 - blocks, 7-5
 - byte ordering, 1-11, 3-2
 - concept, 3-2
 - mapping, 3-4
 - memory operand placement, 3-13
- Block address translation
 - BAT array
 - access protection summary, 7-38
 - address recognition, 7-31
 - BAT register implementation, 7-33
 - fully-associative BAT arrays, 7-29
 - organization, 7-29
 - BAT registers
 - access translation, 2-33
 - BAT area lengths
 - bit description, 2-26
 - general information, 2-25
 - implementation of BAT array, 7-33
 - WIMG bits, 2-26, 5-13, 7-35
 - block address translation flow, 7-17, 7-42
 - block memory protection, 7-37–7-39, 7-57
 - block size options, 7-36
 - definition, 2-25, 7-12
 - generation of physical addresses, 7-40
 - selection of block address translation, 7-13, 7-31
 - summary, 7-42
- BO operand encodings, 2-13, 4-52, B-3
- Boundedly undefined, definition, 4-4
- Branch instructions
 - address calculation, 4-47
 - BO operand encodings, 2-13, 4-52
 - branch conditional
 - absolute addressing mode, 4-50
 - CTR addressing mode, 4-51, B-4
 - LR addressing mode, 4-50
 - relative addressing mode, 4-48
 - branch instructions, 4-55, A-25, F-7
 - branch, relative addressing mode, 4-47
 - condition register logical, 4-56, A-26, F-19
 - conditional branch control, 4-52
 - description, 4-55, A-25
 - simplified mnemonics, F-7
 - system linkage, 4-57, 4-69, A-26
 - trap, 4-57, A-26
- branch instructions
 - BO operand encodings, B-3
- Byte ordering
 - aligned scalars, LE mode, 3-6
 - big-endian mode, default, 3-2, 3-2, 3-6
 - concept, 3-2
 - default, 1-11, 4-8
 - LE and ILE bits in MSR, 1-12, 3-6
 - least-significant bit (lsb), 3-26
 - least-significant byte (LSB), 3-2
 - little-endian mode
 - description, 3-3
 - instruction addressing, 3-10
 - misaligned scalars, LE mode, 3-9
 - most-significant byte (MSB), 3-2
 - nonscalars, 3-10
- C**
- Cache
 - atomic access, 5-4
 - block, definition, 5-1
 - cache coherency maintenance, 5-1
 - cache model, 5-1, 5-5
 - clearing a cache block, 5-9
 - Harvard cache model, 5-5
 - synchronization, 5-3
 - unified cache, 5-5
- Cache block, definition, 5-1
- Cache coherency
 - copy-back operation, 5-14
 - memory/cache access modes, 5-6
 - WIMG bits, 5-12, 7-92
 - write-back mode, 5-14
- Cache implementation, 1-15

INDEX

- Cache management instructions
 - dcbf, 4-67, 5-10, 8-46
 - dcbi, 4-73, 5-19, 8-48
 - dcbst, 4-66, 5-9, 8-49
 - dcbt, 4-65, 5-8, 8-50
 - dcbst, 4-65, 5-8, 8-51
 - dcbz, 4-65, 4-66, 5-9, 8-52
 - eieio, 4-64, 5-2, 8-66
 - icbi, 4-67, 5-11, 8-107
 - isync, 4-64, 5-11, 8-108
 - list of instructions, 4-65, 4-73, A-27
 - Cache model, Harvard, 5-5
 - Caching-inhibited attribute (I)
 - caching-inhibited/allowed operation, 5-6, 5-14
 - Changed (C) bit maintenance
 - page history information, 7-17
 - recording, 7-17, 7-53, 7-55, 7-55
 - updates, 7-91
 - Changes in this revision, summary, 1-9, 1-18
 - Classes of instructions, 4-4, 4-4
 - Classifications, exception, 6-3
 - cmp, 4-18, 8-30
 - cmpl, 4-18, 8-31
 - cmpl, 4-18, 8-32
 - cmpli, 4-18, 8-33
 - cntlzd, 4-20, 8-34
 - cntlzw, 4-20, 8-35
 - Coherence block, definition, 5-1
 - Compare and swap primitive, E-4
 - Compare instructions
 - floating-point, 4-31, A-21
 - integer, 4-17, A-18
 - simplified mnemonics, F-3
 - Computation modes
 - effective address, 4-3
 - PowerPC architecture, 1-4, 4-3
 - Conditional branch control, 4-52
 - Context synchronization
 - data access, 2-41
 - description, 6-6
 - exception, 2-40
 - instruction access, 2-42
 - requirements, 2-40
 - return from exception handler, 6-20
 - Context-altering instruction, definition, 2-40
 - Context-synchronizing instructions, 2-40, 4-9
 - Conventions
 - instruction set
 - classes of instructions, 4-4
 - computation modes, 4-3
 - memory addressing, 4-7
 - sequential execution model, 4-3
 - operand conventions
 - architecture levels represented, 3-1
 - biased exponent values, 3-19
 - significand value, 3-17
 - tiny, definition, 3-18
 - underflow/overflow, 3-16
 - terminology, xxxvii
 - CR (condition register)
 - bit fields, 2-5
 - CR bit and identification symbols, F-1
 - CR logical instructions, 4-56, A-26
 - CR settings, 4-31, B-2
 - CR0/CR1 field definitions, 2-6–2-6
 - CR*n* field, compare instructions, 2-7
 - move to/from CR instructions, 4-58
 - simplified mnemonics, F-19
 - CR logical instructions, 4-56, A-26, F-19
 - crand, 4-56, 8-36
 - crandc, 4-56, 8-37
 - creqv, 4-56, 8-38
 - crnand, 4-56, 8-39
 - crnor, 4-56, 8-40
 - cror, 4-56, 8-41
 - crorc, 4-56, 8-42
 - crxor, 4-56, 8-43
 - CTR (count register)
 - BO operand encodings, 2-13
 - branch conditional to count register, 4-51, B-4
- ## D
- DABR (data address breakpoint register), 2-38, 6-26
 - DAR (data address register)
 - alignment exception register settings, 6-32
 - description, 2-33
 - DSI exception register settings, 6-28
 - Data cache
 - clearing bytes, B-7
 - instructions, 5-8
 - Data cache block allocate instruction, 8-44
 - Data handling and precision, 3-24
 - Data organization, memory, 3-1
 - Data transfer
 - aligned data transfer, 1-12, 3-1
 - I/O data transfer addressing, LE mode, 3-11
 - Data types
 - aligned scalars, 3-6
 - misaligned scalars, 3-9
 - nonscalars, 3-10
 - dcba, 8-44
 - dcbf, 4-67, 5-10, 8-46
 - dcbi, 4-73, 5-19, 8-48
 - dcbst, 4-66, 5-9, 8-49
 - dcbt, 4-65, 5-8, 8-50
 - dcbst, 4-65, 5-8, 8-51

INDEX

dcbz, 4-65, 4-66, 5-9, 8-52, B-7
DEC (decrementer register)
 decrementer operation, 2-37
 POWER and PowerPC, B-9
 writing and reading the DEC, 2-38
Decrementer exception, 6-5, 6-8, 6-38
Defined instruction class, 4-4
Denormalization, definition, 3-23
Denormalized numbers, 3-20
Direct-store facility, *see* Direct-store segment
Direct-store segment
 description, 7-110
 direct-store address translation
 definition, 7-12
 selection, 7-15, 7-19, 7-44, 7-110
 direct-store facility, 7-12
 I/O interface considerations, 5-19
 instructions not supported, 7-112
 integer alignment exception, 6-33
 key bit description, 7-16
 key/PP combinations, conditions, 7-59
 no-op instructions, 7-113
 protection, 7-16
 segment accesses, 7-112
 translation summary flow, 7-113
divd, 4-16, 8-54
divdu, 4-17, 8-56
divw, 4-16, 8-58
divwu, 4-17, 8-60
DSI exception
 description, 6-4
 partially executed instructions, 6-11, 6-25
DSISR register
 settings for alignment exception, 6-32
 settings for DSI exception, 6-27
 settings for misaligned instruction, 6-34

E

EAR (external access register)
 bit format, 2-40
eciwx, 4-68, 8-62
ecowx, 4-68, 8-64
Effective address calculation
 address translation, 2-33, 7-1
 branches, 4-8, 4-47
 EA modifications, 3-7
 loads and stores, 4-8, 4-34, 4-42
eieio, 4-64, 5-2, 8-66
eqv, 4-20, 8-68

Exceptions
 alignment exception, 6-4, 6-30
 asynchronous exceptions, 6-3, 6-8
 classes of exceptions, 6-3, 6-12
 conditions for key/PP combinations, 7-59
 context synchronizing exception, 2-40
 decrementer exception, 6-5, 6-8, 6-38
 DSI exception, 6-4, 6-11, 6-25
 enabling/disabling exceptions, 6-18
 exception classes, 6-3, 6-12
 exception conditions
 inexact, 3-43
 invalid operation, 3-37
 MMU exception conditions, 7-24
 overflow, 3-41
 overview, 6-4
 program exception conditions, 6-5, 6-36, 6-36
 recognizing/handling, 6-1
 underflow, 3-42
 zero divide, 3-38
 exception definitions, 6-22
 exception model, overview, 1-16
 exception priorities, 6-12
 exception processing
 description, 6-14
 stages, 6-2
 steps, 6-19
 exceptions, effects on FPSCR, B-6
 external interrupt, 6-4, 6-8, 6-29
 FP assist exception, 6-5, 6-42
 FP exceptions, B-8
 FP program exceptions, 3-28, 6-5, 6-36, 6-36
 FP unavailable exception, 6-5, 6-38
 FPECR register, 2-20
 IEEE FP enabled program exception
 condition, 6-5, 6-36
 illegal instruction program exception
 condition, 6-5, 6-36
 imprecise exceptions, 6-9
 instruction causing conditions, 4-10
 integer alignment exception, 6-33
 ISI exception, 6-4, 6-28
 LE mode alignment exception, 6-33
 machine check exception, 6-4, 6-8, 6-24
 MMU-related exceptions, 7-23
 overview, 1-16
 precise exceptions, 6-6
 privileged instruction type program exception
 condition, 6-5, 6-37
 program exception, conditions, 6-5, 6-36, 6-36

INDEX

- register settings
 - FPSCR, 3-28
 - MSR, 6-22
 - SRR0/SRR1, 6-14
 - reset exception, 6-4, 6-8, 6-23, 6-23
 - return from exception handler, 6-20
 - summary, 4-10, 6-4
 - synchronous/precise exceptions, 6-3, 6-7
 - system call exception, 6-5, 6-39
 - terminology, 6-2
 - trace exception, 6-5, 6-40
 - translation exception conditions, 7-23
 - trap program exception condition, 6-5, 6-37
 - vector offset table, 6-4
- Exclusive OR (XOR), 3-6
- Execution model
 - floating-point, 3-15
 - IEEE operations, D-1
 - in-order execution, 5-16
 - multiply-add instructions, D-4
 - out-of-order execution, 5-16
 - sequential execution, 4-3
- Execution synchronization, 4-10, 6-7
- Extended mnemonics, *see* Simplified mnemonics
- Extended/primary opcodes, 4-4
- External control instructions, 4-68, 8-62–8-64, A-28
- External interrupt, 6-4, 6-8, 6-29
- extsb, 4-20, 8-69
- extsh, 4-20, 8-70
- extsw, 4-20, 8-71
- F**
- fabs, 4-33, 8-72
- fadd, 4-26, 8-73
- fadds, 4-26, 8-74
- fcfid, 4-30, 8-75
- fcmpo, 4-31, 8-76
- fcmpu, 4-31, 8-77
- fctid, 4-30, 8-78
- fctidz, 4-30, 8-79
- fctiw, 4-30, 8-80
- fctiwz, 4-30, 8-81
- fdiv, 4-27, 8-82
- fdivs, 4-27, 8-83
- Floating-point model
 - biased exponent format, 3-17
 - binary FP numbers, 3-19
 - data handling, 3-24
 - denormalized numbers, 3-20
 - execution model
 - floating-point, 3-15
 - IEEE operations, D-1
 - multiply-add instructions, D-4
 - FE0/FE1 bits, 2-23
 - FP arithmetic instructions, 4-26, A-20
 - FP assist exceptions, 6-5
 - FP compare instructions, 4-31, A-21
 - FP data formats, 3-16
 - FP execution model, 3-15
 - FP load instructions, 4-44, A-24, D-18
 - FP move instructions, 4-33, A-25
 - FP multiply-add instructions, 4-28, A-20
 - FP numbers, conversion, D-5
 - FP program exceptions
 - description, 3-28, 6-36
 - exception conditions, 6-5
 - FE0/FE1 bits, 6-10
 - POWER/PowerPC, MSR bit 20, B-8
 - FP rounding/conversion instructions, 4-29, A-21
 - FP store instructions, 4-46, A-25, B-7, D-19
 - FP unavailable exception, 6-5, 6-38
 - FPR0–FPR31, 2-4
 - FPSCR instructions, 4-31, A-21
 - IEEE floating-point fields, 3-17
 - IEEE-754 compatibility, 1-12, 3-17
 - infinities, 3-21
 - models for FP instructions, D-9
 - NaNs, 3-21
 - normalization/denormalization, 3-23
 - normalized numbers, 3-19
 - precision handling, 3-24
 - program exceptions, 3-28
 - recognized FP numbers, 3-18
 - rounding, 3-25
 - sign of result, 3-22
 - single-precision representation in FPR, 3-25
 - value representation, FP model, 3-18
 - zero values, 3-20

Flow control instructions
 - branch instruction address calculation, 4-47
 - condition register logical, 4-56
 - system linkage, 4-57, 4-69
 - trap, 4-57

fmadd, 4-28, 8-84

fmadds, 4-28, 8-85, 8-85

fmr, 4-33, 8-86

fmsub, 4-29, 8-87

fmsubs, 4-29, 8-88

fmul, 4-26, 8-89

fmuls, 4-27, 8-90, 8-90

fnabs, 4-33, 8-91

fneg, 4-33, 8-92

fnmadd, 4-29, 8-93

fnmadds, 4-29, 8-94, 8-94

fnmsub, 4-29, 8-95

fnmsubs, 4-29, 8-96, 8-96

FP assist exception, 6-42

FP exceptions, 6-38, 6-42

FPCC (floating-point condition code), 4-31

INDEX

- FPECR (floating-point exception cause register), 2-36
 - FPR0–FPR31 (floating-point registers), 2-4
 - FPSCR (floating-point status and control register)
 - bit settings, 2-8, 3-29
 - FP result flags in FPSCR, 3-31
 - FPCC, 4-31
 - FPSCR instructions, 4-31, A-21
 - FR and FI bits, effects of exceptions, B-6
 - move from FPSCR, B-7
 - RN field, 3-26
 - fres, 4-27, 8-97
 - frsp, 3-24, 4-30, 8-99
 - frsqrte, 4-27, 8-100
 - fsel, 4-28, 8-102, D-5
 - fsqrt, 4-27, 8-103
 - fsqrts, 4-27, 8-104
 - fsub, 4-26, 8-105
 - fsubs, 4-26, 8-106
- G**
- GPR0–GPR31 (general purpose registers), 2-3
 - Graphics instructions
 - fres, 4-27, 8-97
 - frsqrte, 4-27, 8-100
 - fsel, 4-28, 8-102
 - stfiwx, 4-46, 8-234
 - Guarded attribute (G)
 - G-bit operation, 5-7, 5-16
 - guarded memory, 5-17
 - out-of-order execution, 5-16
- H**
- Harvard cache model, 5-5
 - Hashed page tables, 7-63
 - Hashed segment table, 7-95
 - Hashing functions
 - page table
 - primary PTEG, 7-70, 7-85
 - secondary PTEG, 7-70, 7-86
 - segment table
 - primary STEG, 7-98
 - secondary STEG, 7-98
 - HTABORG/HTABSIZE, 2-28
- I**
- I/O data transfer addressing, LE mode, 3-11
 - I/O interface considerations
 - direct-store operations, 5-19
 - memory-mapped I/O interface operations, 5-19
 - icbi, 4-67, 5-11, 8-107
 - IEEE 64-bit execution model, D-1
 - IEEE FP enabled program exception
 - condition, 6-5, 6-36
 - Illegal instruction class, 4-6
 - Illegal instruction program exception
 - condition, 6-5, 6-36
 - Imprecise exceptions, 6-9
 - Inexact exception condition, 3-43
 - In-order execution, 5-16
 - Instruction addressing
 - LE mode examples, 3-11
 - Instruction cache instructions, 5-10
 - Instruction restart, 3-14
 - Instruction set conventions
 - classes of instructions, 4-4
 - computation modes, 4-3
 - memory addressing, 4-7
 - sequential execution model, 4-3
 - Instructions
 - 64-bit bridge instructions
 - mfsr, 4-75, 7-118, 8-158
 - mfsrin, 4-75, 7-119, 8-160
 - mtmsr, 4-71, 7-116, 8-169
 - mtrsr, 4-74, 8-175
 - mtsrdr, 4-74, 7-26, 7-123, 8-177
 - mtsrdrin, 4-74, 7-26, 7-123, 8-178
 - mtsrin, 4-74, 7-121, 8-180
 - optional instructions, 4-5
 - rfti, 4-70, 6-20, 7-116, 8-195
 - boundedly undefined, definition, 4-4
 - branch instructions
 - branch address calculation, 4-47
 - branch conditional
 - absolute addressing mode, 4-50
 - CTR addressing mode, 4-51
 - LR addressing mode, 4-50
 - relative addressing mode, 4-48
 - branch instructions, 4-55, A-25, F-7
 - condition register logical, 4-56
 - conditional branch control, 4-52
 - description, 4-55, A-25
 - effective address calculation, 4-47
 - system linkage, 4-57, 4-69
 - trap, 4-57
 - cache management instructions
 - dcbf, 4-67, 5-10, 8-46
 - dcbi, 4-73, 5-19, 8-48
 - dcbst, 4-66, 5-9, 8-49
 - dcbt, 4-65, 5-8, 8-50
 - dcbtst, 4-65, 5-8, 8-51
 - dcbz, 4-65, 4-66, 5-9, 8-52
 - eiemo, 4-64, 5-2, 8-66
 - icbi, 4-67, 5-11, 8-107
 - isync, 4-64, 5-11, 8-108
 - list of instructions, 4-65, 4-73, A-27

INDEX

- classes of instructions, 4-4
 - condition register logical, 4-56, A-26
 - conditional branch control, 4-52
 - context-altering instructions, 2-40
 - context-synchronizing instructions, 2-40, 4-9
 - defined instruction class, 4-4
 - execution synchronization, 3-35
 - external control instructions, 4-5, 4-68, A-28
 - floating-point
 - arithmetic, 4-26, 8-82, A-20
 - compare, 4-31, 8-76, A-21, F-3
 - computational instructions, 3-15
 - FP conversions, D-5
 - FP load instructions, 4-44, A-24, D-18
 - FP move instructions, 4-33, A-25
 - FP store instructions, A-25, B-7, D-19
 - FPSCR instructions, 4-31, A-21
 - models for FP instructions, D-9
 - multiply-add, 4-28, A-20, D-4
 - noncomputational instructions, 3-15
 - rounding/conversion, 4-29, 8-78–8-81, A-21
 - flow control instructions
 - branch address calculation, 4-47
 - CR logical, 4-56
 - system linkage, 4-57, 4-69
 - trap, 4-57
 - graphics instructions
 - fres, 4-27, 8-97
 - frsqtr, 4-27, 8-100
 - fsel, 4-28, 8-102
 - stfiwx, 4-46, 8-234
 - illegal instruction class, 4-6
 - instruction fetching
 - branch/flow control instructions, 4-47
 - direct-store segment, 7-23
 - exception processing steps, 6-19
 - exception synchronization steps, 6-6
 - instruction cache instructions, 5-10
 - integer store instructions, 4-39
 - multiprocessor systems, 5-11
 - precise exceptions, 6-6
 - uniprocessor systems, 5-10
 - instruction field conventions, xxxvii
 - instructions not supported, direct-store, 7-112
 - integer
 - arithmetic, 4-2, 4-11, A-17
 - compare, 4-17, A-18, F-3
 - load, 4-36, A-22, A-22
 - load/store multiple, 4-41, A-23, B-5
 - load/store string, 4-42, A-24, B-5
 - load/store with byte reverse, 4-40, A-23
 - logical, 4-2, 4-18, A-18
 - rotate/shift, 4-21–4-23, A-19–A-19, F-4
 - store, 4-38, A-23
 - invalid instruction forms, 4-5
 - load and store
 - address generation, floating-point, 4-42
 - address generation, integer, 4-34
 - byte reverse instructions, 4-40, A-23
 - floating-point load, 4-44, A-24
 - floating-point move, 4-33, A-25
 - floating-point store, 4-45, B-7
 - integer load, 4-36, A-22, A-22
 - integer store, 4-38, A-23
 - memory synchronization, 4-59, 4-60, 4-63, A-24
 - multiple instructions, 4-41, A-23, B-5
 - string instructions, 4-42, A-24, B-5
 - lookaside buffer management
 - instructions, 4-72, 4-75, A-28
 - memory control instructions, 4-64, 4-72
 - memory synchronization instructions
 - eieio, 4-64, 5-2, 8-66
 - isync, 4-64, 5-11, 8-108
 - ldarx, 4-60, 8-114
 - list of instructions, 4-60, 4-63, A-24
 - lwarx, 4-60, 8-141
 - stdcx., 4-61, 8-225
 - stwcx., 4-61, 8-249
 - sync, 4-61, 5-3, 8-260, B-5
 - mfsrin, 7-119
 - mtsr, 7-120, 7-123
 - mtrsrin, 7-121
 - new instructions
 - mtmsrd, 7-92, 8-171
 - rfid, 8-197
 - no-op, 4-5, F-23
 - optional instructions, 4-5
 - partially executed instructions, 6-11
 - POWER instructions
 - deleted in PowerPC, B-9
 - supported in PowerPC, B-11
 - PowerPC instructions, list, A-1, A-9, A-17
 - preferred instruction forms, 4-5
 - processor control
 - instructions, 4-58, 4-62, 4-70, A-27
 - reserved bits, POWER and PowerPC, B-2
 - reserved instructions, 4-7
 - segment register manipulation
 - instructions, 4-73, A-28
 - SLB management instructions, 4-75, 4-75, A-28
 - supervisor-level cache management
 - instructions, 4-72
 - supervisor-level instructions, 4-10
 - system linkage instructions, 4-57, 4-69, A-26
 - TLB management instructions, 4-75, A-28
 - trap instructions, 4-57, A-26
- Integer alignment exception, 6-33
- Integer arithmetic instructions, 4-2, 4-11, A-17
- Integer compare instructions, 4-17, A-18, F-3
- Integer load instructions, 4-36, A-22, A-22

INDEX

Integer logical instructions, 4-2, 4-18, A-18
Integer rotate and shift instructions, F-4
Integer rotate/shift instructions, 4-21–4-23, A-19–A-19, F-4
Integer store instructions
 description, 4-38
 instruction fetching, 4-39
 list, A-23
Interrupts, *see* Exceptions
Invalid instruction forms, 4-5
Invalid operation exception condition, 3-37
ISI exception, 6-4, 6-28
isync, 4-64, 5-11, 8-108

K

Key (Ks, Kp) protection bits, 7-57

L

lbz, 4-37, 8-109
lbzu, 4-37, 8-110
lbzux, 4-37, 8-111
lbzx, 4-37, 8-112
ld, 4-38, 8-113
ldarx, 4-59, 4-60, 8-114
ldarx/stdcx.
 general information, 5-4, E-1
 ldarx, 4-60, 8-114
 semaphores, 4-59
 stdcx., 4-61, 8-225
ldu, 4-38, 8-115
ldux, 4-38, 8-116
ldx, 4-38, 8-117
lfd, 4-45, 8-118
lfdx, 4-45, 8-119
lfdx, 4-45, 8-120
lfdx, 4-45, 8-121
lfs, 4-44, 8-122
lfsu, 4-45, 8-123
lfsux, 4-45, 8-124
lfsx, 4-45, 8-125
lha, 4-37, 8-126
lhau, 4-37, 8-127
lhax, 4-37, 8-128
lhax, 4-37, 8-129
lhbrx, 4-40, 8-130
lhz, 4-37, 8-131
lhzu, 4-37, 8-132
lhzux, 4-37, 8-133
lhzx, 4-37, 8-134
Little-endian mode
 alignment exception, 6-33
 byte ordering, 3-3, 3-6
 description, 3-3

I/O data transfer addressing, 3-11
instruction addressing, 3-10
LE and ILE bits, 3-6
mapping, 3-5
misaligned scalars, 3-9
munged structure *S*, 3-7–3-8
LK bit, inappropriate use, B-3
lmw, 4-41, 8-135, B-5
Load/store
 address generation, floating-point, 4-43
 address generation, integer, 4-34
 byte reverse instructions, 4-40, A-23
 floating-point load instructions, 4-44, A-24
 floating-point move instructions, 4-33, A-25
 floating-point store instructions, 4-45, A-25, B-7
 integer load instructions, 4-36, A-22, A-22
 integer store instructions, 4-38, A-23
 load/store multiple instructions, 4-41, A-23, B-5
 memory synchronization instructions, 4-59, A-24
 string instructions, 4-42, A-24, B-5
Logical addresses
 translation into physical addresses, 7-1
Logical instructions, integer, 4-2, 4-18, A-18
Lookaside buffer management
 instructions, 4-72, 4-75, A-28
lswi, 4-42, 8-136, B-5
lswx, 4-42, 8-138, B-5
lwa, 4-38, 8-140
lwarx, 4-59, 4-60, 8-141
lwarx/stwxc.
 general information, 5-4, E-1
 list insertion, E-6
 lwarx, 4-60, 8-141
 semaphores, 4-59
 stwxc., 4-61, 8-249
 synchronization primitive examples, E-2
lwaux, 4-38, 8-142
lwax, 4-38, 8-143
lwbrx, 4-40, 8-144
lwz, 4-37, 8-145
lwzu, 4-38, 8-146
lwzux, 4-38, 8-147
lwzx, 4-38, 8-148

M

Machine check exception
 causing conditions, 6-4, 6-8, 6-24
 non-recoverable, causes, 6-24
 register settings, 6-25
mcrf, 4-56, 8-149
mcrfs, 4-32, 8-150
mcrxr, 4-58, 8-151

INDEX

- Memory access
 - ordering, 5-2
 - update forms, B-4
- Memory addressing, 4-7
- Memory coherency
 - coherency controls, 5-5
 - coherency precautions, 5-7
 - M-bit operation, 5-7, 5-7, 5-15
 - memory access modes, 5-6
 - sync instruction, 5-3
- Memory control instructions
 - segment register manipulation, 4-73, A-28
 - SLB management, 4-75, 4-75, A-28
 - supervisor-level cache management, 4-72
 - TLB management, 4-75
 - user-level cache, 4-64
- Memory management unit
 - address translation flow, 7-17
 - address translation mechanisms, 7-12, 7-17
 - address translation types, 7-14
 - block address translation, 7-13, 7-17, 7-28
 - conceptual block diagram, 7-9, 7-11
 - direct-store address translation, 7-19, 7-110
 - exceptions summary, 7-22
 - features summary, 7-3
 - hashing functions, 7-70, 7-98
 - instruction summary, 7-26
 - locating the segment descriptor, 7-12
 - memory addressing, 7-6
 - memory protection, 7-15, 7-39, 7-57
 - MMU exception conditions, 7-24
 - MMU organization, 7-7
 - MMU registers, 7-27
 - MMU-related exceptions, 7-22
 - overview, 1-16, 7-4
 - page address translation, 7-12, 7-19, 7-44, 7-61
 - page history status, 7-17, 7-53, 7-55
 - page table search operation, 7-63, 7-87
 - real addressing mode
 - translation, 7-15, 7-17, 7-27, 7-43
 - register summary, 7-27
 - segment model, 7-42
 - segment tables
 - in memory (64-bit implementations), 7-47, 7-95
 - search operation, 7-106
 - updates in memory, 7-107
 - virtual address (52-bit), 7-44
- Memory operands, 3-2, 4-7
- Memory segment model
 - description, 7-42
 - memory segment selection, 7-43
- page address translation
 - overview, 7-44
 - PTE definitions, 7-51
 - segment descriptor definitions, 7-47
 - summary, 7-61
- page history recording
 - changed (C) bit, 7-55
 - description, 7-53
 - referenced (R) bit, 7-54
 - table search operations, update history, 7-54
- page memory protection, 7-57
- recognition of addresses, 7-43
- referenced/changed bits
 - changed (C) bit, 7-55
 - guaranteed bit settings, model, 7-56
 - recording scenarios, 7-55
 - referenced (R) bit, 7-54
 - synchronization of updates, 7-57
 - table search operations, update history, 7-54
 - updates to page tables, 7-91
- Memory synchronization
 - eieio, 4-64, 5-2, 8-66
 - isync, 4-64, 5-11, 8-108
 - ldarx, 4-59, 4-60, 8-114
 - list of instructions, 4-60, 4-63, A-24
 - lwarx, 4-59, 4-60, 8-141
 - stdcx., 4-59, 4-61, 8-225
 - stwcx., 4-59, 4-61, 8-249
 - sync, 4-61, 5-3, 8-260, B-5
- Memory, data organization, 3-1
- Memory/cache access modes, *see* WIMG bits
- mfcrr, 4-58, 8-152
- mffs, 4-32, 8-153
- mfmrsr, 4-71, 8-154, B-1
- mfspr, 4-58, 4-71, 8-155, B-6
- mfsr (64-bit bridge), 4-74, 7-118, 8-158, B-1
- mfsrin (64-bit bridge), 4-75, 7-119, 8-160
- mftb, 4-62, 8-162
- Migration to PowerPC, B-1
- Misaligned accesses and alignment, 3-1
- Mnemonics
 - recommended mnemonics, F-23
 - simplified mnemonics, F-1
- Move to/from CR instructions, 4-58
- MSR (machine state register)
 - bit settings, 2-21, 6-16
 - EE bit, 6-18
 - FE0/FE1 bits, 2-23, 6-10
 - FE0/FE1 bits and FP exceptions, 3-34
 - format, 6-15
 - ISF bit (64-bit bridge), 2-21, 6-16, 7-116
 - LE and ILE bits, 1-12, 3-6
 - optional bits (SE and BE), 2-22
 - RI bit, 6-21
 - settings due to exception, 6-22

INDEX

- SF bit (64-/32-bit mode), 4-3
 - state of MSR at power up, 2-23
- mtcrf, 4-58, 8-164
- mtfsb0, 4-32, 8-165
- mtfsb1, 4-32, 8-166
- mtfsf, 4-32, 8-167
- mtfsfi, 4-32, 8-168
- mtmsr (64-bit bridge), 4-71, 7-116, 8-169
- mtmsrd, 4-71, 7-92, 8-171
- mtspr, 4-58, 4-71, 8-172, B-6
- mtsr (64-bit bridge), 4-74, 7-120, 7-123, 8-175
- mtsrđ (64-bit bridge), 7-26, 7-123, 8-177
- mtsrđin (64-bit bridge), 7-26, 7-123, 8-178
- mtsrin (64-bit bridge), 4-74, 7-121, 8-179
- mulhd, 4-16, 8-181
- mulhdu, 4-16, 8-182
- mulhw, 4-16, 8-183
- mulhwu, 4-16, 8-184
- mullđ, 4-15, 8-185
- mulli, 4-15, 8-186
- mullw, 4-15, 8-187
- Multiple register loads, B-5
- Multiple-precision shift examples, C-1
- Multiply-add
 - execution model, D-4
 - instructions, floating-point, 4-28, A-20
- Multiprocessor, usage, 5-1
- Munging
 - description, 3-6
 - LE mapping, 3-7–3-8
- N**
- nand, 4-19, 8-188
- NaNs (Not a Numbers), 3-21
- neg, 4-15, 8-189
- No-execute protection, 7-3, 7-15, 7-18, 7-48
- Nonscalars, 3-10
- No-op, 4-5, F-23
- nor, 4-19, 8-190
- Normalization, definition, 3-23
- Normalized numbers, 3-19
- O**
- OEA (operating environment architecture)
 - 64-bit bridge description, 1-4
 - cache model and memory coherency, 5-1
 - definition, xxviii, 1-5
 - general changes to the architecture, 1-21, 1-21
 - implementing exceptions, 6-1
 - memory management specifications, 7-1
 - programming model, 2-18
 - register set, 2-17
- Opcodes, primary/extended, 4-4
- Operands
 - BO operand encodings, 2-13, 4-52, B-3
 - conventions, description, 1-11, 3-1
 - memory operands, 4-7
 - placement
 - effect on performance, summary, 3-12
 - instruction restart, 3-14
- Operating environment architecture, *see* OEA
- Operating system migration, 32-bit to 64-bit, 7-115
- Optional instructions, 4-5, A-41
- or, 4-19, 8-191
- orc, 4-20, 8-192
- ori, 4-19, 8-193
- oris, 4-19, 8-194
- Out-of-order execution, 5-16
- Overflow exception condition, 3-41
- P**
- Page address translation
 - definition, 7-12
 - generation of physical addresses, 7-44
 - integer alignment exception, 6-33
 - overview, 7-44
 - page address translation flow, 7-61
 - page memory protection, 7-37, 7-57
 - page size, 7-42
 - page tables in memory, 7-63
 - PTE definitions, 7-51
 - segment descriptors, 7-43, 7-47
 - selection of page address translation, 7-12, 7-19
 - summary, 7-61
 - table search operation, 7-87
 - virtual address and virtual segment ID, 7-44
- Page history status
 - making R and C bit updates to page tables, 7-91
 - R and C bit recording, 7-17, 7-53, 7-55
 - R and C bit updates, 7-91
- Page memory protection, *see* Protection of memory areas
- Page tables
 - allocation of PTEs, 7-77
 - definition, 7-64
 - example table structures, 7-78–7-81
 - hashed page tables, 7-63
 - hashing functions, 7-70, 7-85
 - organized as PTEGs, 7-64
 - page table size, 7-67
 - page table structure summary, 7-77
 - page table updates, 7-91
 - PTE format, 7-51
 - PTEG addresses, 7-72, 7-81
 - table search flow, 7-89
 - table search for PTE, 7-87
- Page, definition, 5-5

INDEX

- Performance
 - effect of operand placement, summary, 3-12
 - instruction restart, 3-14
- Physical address generation
 - block physical address generation, 7-40
 - generation of PTEG addresses, 7-72, 7-81
 - generation of STEG addresses, 7-100, 7-103
 - memory management unit, 7-1
 - page physical address generation, 7-44
- Physical memory
 - physical vs. virtual memory, 5-1
 - predefined locations, 7-6
- PIR (processor identification register), 2-40
- POWER architecture
 - AL bit in MSR, B-2
 - alignment for load/store multiple, B-5
 - branch conditional to CTR, B-4
 - differences in implementations, B-4
 - FP exceptions, B-8
 - instructions
 - dclz/dcbz instructions, differences, B-7
 - deleted in PowerPC, B-9
 - load/store multiple, alignment, B-5
 - load/store string instructions, B-5
 - move from FPSCR, B-7
 - move to/from SPR, B-6
 - reserved bits, POWER and PowerPC, B-2
 - SR instructions, differences from PowerPC, B-7
 - supported in PowerPC, B-11
 - svcx/sc instructions, differences, B-4
 - memory access update forms, B-4
 - migration to PowerPC, B-1
 - POWER/PowerPC incompatibilities, B-1
 - registers
 - CR settings, B-2
 - decrementer register, B-9
 - multiple register loads, B-5
 - reserved bits, POWER and PowerPC, B-2
 - RTC (real-time clock), B-8
 - synchronization, B-5
 - timing facilities, POWER and PowerPC, B-8
 - TLB entry invalidation, B-8
- PowerPC architecture
 - alignment for load/store multiple, B-5
 - byte ordering, 3-6
 - cache model, Harvard, 5-5
 - changes in this revision, summary, 1-9, 1-18
 - computation modes, 1-4, 4-3
 - differences in implementations, B-4
 - features summary
 - defined features, 1-2, 1-7
 - features not defined, 1-8
 - I/O data transfer addressing, 3-11
 - instruction addressing, 3-10
 - instruction list, A-1, A-9, A-17
 - instructions
 - dcbz/dclz instructions, differences, B-7
 - deleted in POWER, B-9
 - load/store multiple, alignment, B-5
 - load/store string instructions, B-5
 - move from FPSCR, B-7
 - move to/from SPR, B-6
 - reserved bits, POWER and PowerPC, B-2
 - SR instructions, differences from POWER, B-7
 - supported in POWER, B-11
 - svcx/sc instructions, differences, B-4
 - levels of the PowerPC architecture, 1-5–1-7
 - memory access update forms, B-4
 - operating environment architecture, xxviii, 1-5
 - overview, 1-2
 - POWER/PowerPC, incompatibilities, B-1
 - registers
 - CR settings, B-2
 - decrementer register, B-9
 - multiple register loads, B-5
 - programming model, 1-10, 2-2, 2-14, 2-18
 - reserved bits, POWER and PowerPC, B-2
 - synchronization, B-5
 - timing facilities, POWER and PowerPC, B-8
 - TLB entry invalidation, B-8
 - user instruction set architecture, xxvii, 1-5
 - virtual environment architecture, xxvii, 1-5
 - PP protection bits, 7-57
 - Precise exceptions, 6-3, 6-6, 6-7
 - Preferred instruction forms, 4-5
 - Primary/extended opcodes, 4-4
 - Priorities, exception, 6-12
 - Privilege levels
 - external control instructions, 4-68
 - supervisor/user mode, 1-11
 - supervisor-level cache control instruction, 4-72
 - TBR encodings, 4-62
 - user-level cache control instructions, 4-64
 - Privileged instruction type program exception condition, 6-5, 6-37
 - Privileged state, *see* Supervisor mode
 - Problem state, *see* User mode
 - Process switching, 6-21
 - Processor control instructions, 4-58, 4-62, 4-70, A-27
 - Program exception
 - description, 3-28, 6-5, 6-36, 6-36
 - five (5) program exception conditions, 6-5, 6-36
 - move to/from SPR, B-6
 - Programming model
 - all registers (OEA), 2-18
 - user-level plus time base (VEA), 2-14
 - user-level registers (UISA), 2-2

INDEX

- Protection of memory areas
 - block access protection, 7-37, 7-37, 7-39, 7-57
 - direct-store segment protection, 7-16, 7-112
 - no-execute protection, 7-3, 7-15, 7-18, 7-48
 - options available, 7-15, 7-57
 - page access protection, 7-37, 7-39, 7-57
 - programming protection bits, 7-57
 - protection violations, 7-22, 7-39, 7-58
 - PTEGs (PTE groups)
 - definition, 7-64
 - example primary and secondary PTEGs, 7-81
 - generation of PTEG addresses, 7-72
 - table search operation, 7-87
 - PTEs (page table entries)
 - adding a PTE, 7-92
 - modifying a PTE, 7-93
 - page address translation, 7-44
 - page table definition, 7-64
 - page table search operation, 7-87
 - page table updates, 7-91
 - PTE bit definitions, 7-52, 7-53
 - PTE format, 7-51
 - PVR (processor version register), 2-24
- Q**
- Quiet NaNs (QNaNs)
 - description, 3-21
 - representation, 3-22
- R**
- Real address (RA), *see* Physical address generation
 - Real addressing mode address translation (translation disabled)
 - data/instruction accesses, 7-15, 7-17, 7-27, 7-43
 - definition, 7-12
 - selection of address translation, 7-15
 - Real numbers, approximation, 3-18
 - Record bit (Rc)
 - description, 8-4
 - inappropriate use, B-3
 - Referenced (R) bit maintenance
 - page history information, 7-17
 - recording, 7-17, 7-53, 7-54, 7-55
 - updates, 7-91
 - Registers
 - configuration registers
 - MSR, 2-20
 - PVR, 2-24
 - exception handling registers
 - DAR, 2-33
 - DSISR, 2-34
 - FPECR (optional), 2-36
 - list, 2-19
 - SPRG0–SPRG3, 2-33
 - SRR0/SRR1, 2-34
 - FPECR register (optional), 2-20
 - memory management registers
 - ASR, 2-30
 - BATs, 2-25
 - list, 2-19
 - SDR1, 2-28
 - SRs, 2-31
 - miscellaneous registers
 - DABR (optional), 2-38
 - DEC, 2-37
 - EAR (optional), 2-39
 - list, 2-20
 - PIR (optional), 2-40
 - TBL/TBU, 2-15
 - MMU registers, 7-27
 - multiple register loads, B-5
 - OEA register set, 2-17
 - optional registers
 - DABR, 2-38
 - EAR, 2-39
 - FPECR, 2-36
 - PIR, 2-40
 - reserved bits, POWER and PowerPC, B-2
 - supervisor-level
 - ASR, 2-30
 - BATs, 2-25, 7-34
 - DABR, 6-26
 - DABR (optional), 2-38
 - DAR, 2-33
 - DEC, 2-37, B-9
 - DSISR, 2-34
 - EAR (optional), 2-39
 - FPECR (optional), 2-36
 - MSR, 2-20
 - PIR (optional), 2-40
 - PVR, 2-24
 - SDR1, 2-28
 - SPRG0–SPRG3, 2-33
 - SRR0/SRR1, 2-34
 - SRs, 2-31
 - TBL/TBU, 2-15
 - UISA register set, 2-1

INDEX

- user-level
 - CR, 2-5
 - CTR, 2-12
 - FPR0–FPR31, 2-4
 - FPSCR, 2-7
 - GPR0–GPR31, 2-3
 - LR, 2-11
 - TBL/TBU, 2-36
 - XER, 2-11, B-4
 - VEA register set, 2-13
 - Reserved instruction class, 4-7
 - Reset exception, 6-4, 6-8, 6-23
 - Return from exception handler, 6-20
 - rfi (64-bit bridge), 4-69, 6-20, 7-116, 8-195
 - rfid, 8-197
 - rldcl, 4-22, 8-198
 - rldcr, 4-23, 8-199
 - rldic, 4-22, 8-200
 - rldicl, 4-22, 8-201
 - rldicr, 4-22, 8-203
 - rldimi, 4-23, 8-204
 - rlwimi, 4-23, 8-205
 - rlwinm, 4-22, 8-206
 - rlwnm, 4-23, 8-208
 - Rotate/shift instructions, 4-21–4-23, A-19–A-19, F-4
 - Rounding, floating-point operations, 3-25
 - Rounding/conversion instructions, FP, 4-29
 - RTC (real time clock), B-8
- S**
- sc
 - differences in implementation, POWER and PowerPC, B-4
 - for context synchronization, 4-9
 - occurrence of system call exception, 6-39
 - user-level function, 4-57, 4-69, 8-209
 - Scalars
 - aligned, LE mode, 3-6
 - big-endian, 3-2
 - description, 3-2
 - little-endian, 3-2
 - SDR1 register
 - bit settings, 2-28
 - definitions, 7-65
 - format, 7-65
 - generation of PTEG addresses, 7-72, 7-81
 - Segment registers
 - instructions
 - 32-bit implementations only, 7-50
 - POWER/PowerPC, differences, B-7
 - segment descriptor
 - 64-bit bridge requirements, 7-47
 - definitions, 7-47
 - format, 7-49
 - SR manipulation instructions, 4-73, 4-73, A-28
 - T = 1 format (direct-store), 7-111
 - T-bit, 2-32, 7-43
 - Segment table entries (STEs), 7-10
 - Segment tables
 - 32-bit mode (64-bit bridge), 7-103
 - adding an STE, 7-108
 - address generation, 7-100
 - allocation of STEs, 7-101
 - definition, 7-95
 - deleting an STE, 7-109
 - hashing functions, 7-95, 7-98
 - modifying an STE, 7-109
 - organized as STEGs, 7-96
 - segment table updates, 7-107
 - STE format, 7-47
 - STEG addresses, 7-100, 7-103
 - table search operation, 7-106
 - table structures with examples, 7-103
 - Segmented memory model, *see* Memory management unit
 - Sequential execution model, 4-3
 - Shift/rotate instructions, 4-21–4-23, A-19–A-19, F-4
 - Signaling NaNs (SNaNs), 3-21
 - Simplified mnemonics
 - branch instructions, F-7
 - compare instructions, F-3
 - CR logical instructions, F-19
 - recommended mnemonics, 4-61, F-23
 - rotate and shift, F-4
 - special-purpose registers (SPRs), F-22
 - subtract instructions, F-2
 - trap instructions, F-20
 - SLB management instructions, 4-75, 4-75, A-28
 - slbia, 4-76, 8-210
 - slbie, 4-76, 8-211
 - SLBs (segment lookaside buffers)
 - description, 7-2
 - segment table entries (STEs), 7-95
 - SLB invalidate
 - broadcast operations, 7-108
 - slbia instruction, 7-25, 7-25
 - slbie instruction, 7-25, 7-25, 7-108
 - sld, 4-24, 8-212
 - slw, 4-24, 8-213
 - SNaNs (signaling NaNs), 3-21
 - Special-purpose registers (SPRs), F-22
 - SPRG0–SPRG3, conventional uses, 2-34
 - srad, 4-25, 8-214
 - sradi, 4-24, 8-215
 - sraw, 4-25, 8-216
 - srawi, 4-25, 8-217
 - srd, 4-24, 8-218

INDEX

- SRR0/SRR1 (status save/restore registers)
 - format, 2-34, 2-35
 - machine check exception, register settings, 6-25
- srw, 4-24, 8-219
- stb, 4-39, 8-220
- stbu, 4-39, 8-221
- stbux, 4-39, 8-222
- stbx, 4-39, 8-223
- std, 4-40, 8-224
- stdcx., 4-59, 4-61, 8-225
- stdcx./ldarx
 - general information, 5-4, E-1
 - ldarx, 4-60, 8-114
 - semaphores, 4-59
 - stdcx., 4-61, 8-225
- stdu, 4-40, 8-227
- stdux, 4-40, 8-228
- stdx, 4-40, 8-229
- STEGs (STE groups)
 - definition, 7-96
 - example primary and secondary STEGs, 7-103
 - generation of STEG addresses, 7-100
 - table search operation, 7-106
- STEs (segment table entries)
 - segment descriptors in hashed segment table, 7-95
 - segment table definition, 7-96
 - segment table search operation, 7-106
 - STE format, 7-47
 - updating segment tables, 7-107
- stfd, 4-46, 8-230
- stfdu, 4-46, 8-231
- stfdx, 4-46, 8-232
- stfdx, 4-46, 8-233
- stfiwx, 4-46, 8-234, D-19
- stfs, 4-46, 8-235
- stfsu, 4-46, 8-236
- stfsux, 4-46, 8-237
- stfsx, 4-46, 8-238
- sth, 4-39, 8-239
- sthbrx, 4-41, 8-240
- sth, 4-39, 8-241
- sthux, 4-39, 8-242
- sthx, 4-39, 8-243
- stmw, 4-41, 8-244
- Structure mapping examples, 3-3
- stswi, 4-42, 8-245
- stswx, 4-42, 8-246
- stw, 4-39, 8-247
- stwbrx, 4-41, 8-248
- stwcx., 4-59, 4-61, 8-249
- stwcx./lwarx
 - general information, 5-4, E-1
 - lwarx, 4-60, 8-141
 - semaphores, 4-59
 - stwcx., 4-61, 8-249
 - synchronization primitive examples, E-2
- stwu, 4-39, 8-251
- stwux, 4-40, 8-252
- stwx, 4-39, 8-253
- subf, 4-13, 8-254
- subfc, 4-13, 8-255
- subfe, 4-14, 8-256
- subfic, 4-13, 8-257
- subfme, 4-14, 8-258
- subfze, 4-15, 8-259
- Subtract instructions, F-2
- Summary of changes in this revision, 1-9, 1-18
- Supervisor mode, *see* Privilege levels
- sync, 4-61, 5-3, 8-260, B-5
- Synchronization
 - compare and swap, E-4
 - context/executing synchronization, 2-40, 4-9, 6-6
 - context-altering instruction, 2-40
 - context-synchronizing exception, 2-40
 - context-synchronizing instruction, 2-40
 - data access synchronization, 2-41
 - execution of rfi, 6-20
 - implementation-dependent
 - requirements, 2-42, 2-44
 - instruction access synchronization, 2-42
 - list insertion, E-6
 - lock acquisition and release, E-5
 - memory synchronization instructions, 4-59, A-24
 - overview, 6-6
 - requirements for lookaside buffers, 2-40
 - requirements for special registers, 2-40
 - rfi/rfid, 2-41
 - synchronization primitives, E-2
 - synchronization programming examples, E-1
 - synchronizing instructions, 1-13, 2-41
- Synchronous exceptions
 - causes, 6-3
 - classifications, 6-3
 - exception conditions, 6-7
- System call exception, 6-5, 6-39
- System IEEE FP enabled program exception
 - condition, 6-5, 6-36
- System linkage instructions
 - list of instructions, A-26
 - rfi, 8-195
 - rfid, 4-70, 8-197
 - sc, 4-57, 4-69, 8-209
- System reset exception, 6-4, 6-8, 6-23

INDEX

T

Table search operations
 hashing functions, 7-70, 7-98
 page table algorithm, 7-87
 page table definition, 7-64
 SDR1 register, 7-65
 segment table algorithm, 7-106
 segment table definition, 7-96
 segment table search flow, 7-106
 table search flow (primary and secondary), 7-89

td, 4-57, 8-261

tdi, 4-57, 8-262

Terminology conventions, xxxvii

Time base
 computing time of day, 2-17
 reading the time base, 2-16
 TBL/TBU, 2-15
 timer facilities, POWER and PowerPC, B-8
 writing to the time base, 2-36

Tiny values, definition, 3-18

TLB invalidate
 TLB entry invalidation, B-8
 TLB invalidate broadcast operations, 7-27, 7-91
 TLB management instructions, A-28
 tlbie instruction, 7-27, 7-91

TLB management instructions, 4-75

tlbia, 4-76, 8-263

tlbie, 4-76, 8-264, B-8

tlbsync, 4-76, 8-265

tlbsync instruction emulation, 7-91

TO operand, F-22

Trace exception, 6-5, 6-40

Trap instructions, 4-57, F-20

Trap program exception condition, 6-5, 6-37

tw, 4-57, 8-266

twi, 4-57, 8-267

U

UISA (user instruction set architecture)
 definition, xxvii, 1-5
 general changes to the architecture, 1-19
 programming model, 2-2
 register set, 2-1

Underflow exception condition, 3-42

User instruction set architecture, *see* UISA

User mode, *see* Privilege levels

User-level registers, list, 2-2, 2-14

V

VEA (virtual environment architecture)
 cache model and memory coherency, 5-1
 definition, xxvii, 1-5
 general changes to the architecture, 1-20, 1-20
 programming model, 2-14
 register set, 2-13
 time base, 2-15

Vector offset table, exception, 6-4

Virtual address
 formation, 2-33

Virtual address (52-bit)
 logical-to-virtual-to-physical address
 translation, 7-44

Virtual environment architecture, *see* VEA

Virtual memory
 implementation, 7-4
 virtual vs. physical memory, 5-1

W

WIMG bits, 5-6, 7-92
 description, 5-12
 G-bit, 5-16
 in BAT registers, 2-26, 5-13, 7-35
 WIM combinations, 5-15

Write-back mode, 5-14

Write-through attribute (W)
 write-through/write-back operation, 5-6, 5-13

X

XER register
 bit definitions, 2-11
 difference from POWER architecture, B-4

xor, 4-19, 8-268

XOR (exclusive OR), 3-6

xori, 4-19, 8-269

xoris, 4-19, 8-270

Z

Zero divide exception condition, 3-38

Zero numbers, format, 3-20

Zero values, 3-20

INDEX